

PRESSURE WASHERS

| PARTS & ACCESSORIES

| DETERGENTS

EVERYTHING HOTSY

THE BRAND
THE PROS
USE



The
Pressure Dr
SALES & SERVICE

1024 BRYDEN AVE SUITE 1
LEWISTON, ID 83501
(208) 790-0365

WWW.THEPRESSUREDR.COM

Hotsty®

THE # 1 PRESSURE WASHER IN NORTH AMERICA

TABLE OF CONTENTS

HOTSY PRESSURE WASHERS	2
HOTSY HEATERS	15
HOTSY BRANDED PARTS	16
HOTSY DETERGENTS	35
GUNS & LANCES	45
HOSE & HOSE REELS	53
COUPLERS, FITTINGS & FILTERS	64
NOZZLES	78
PUMPS & PUMP KITS	91
UNLOADERS, INJECTORS, VALVES & GUAGES	116
ENGINES, MOTORS & PULLEYS	136
BURNERS	142
ELECTRICAL COMPONENTS	154
CHASSIS COMPONENTS	165
PRESSURE WASHER ACCESSORIES	167
CAR WASH BAY ACCESSORIES	177
PARTS WASHER PARTS	184
AG SPRAY ACCESSORIES	189
CARPET & RESTORATION	195



HOTSY PRESSURE WASHERS / HOT WATER

333 MODEL

- Oil-Fired Heater
- 1.7 GPM @ 1200 PSI
- Auto Start/Stop



The **333 Model** is a competitively priced, entry-class hot water pressure washer. Innovative upright design ensures good mobility and ergonomics, while its compact size makes it easy to transport both horizontally and vertically. Built-in 3 angle spray nozzle, and low pressure chemical application. Very user-friendly with one switch operation and areas for hose and accessory storage. Equipped with 33-ft. high-pressure hose and 16' power cord.



MODEL	PART NO.	GPM	PSI	HP	VOLT/PH	AMPS	FUEL	BTU/HR	PUMP MODEL	PORTABILITY	DIMENSIONS	SHIP WT (lbs)
333	1.064-049.0	1.7	1200	2.3	115/1	12.5	Oil	80,000	Axial	Std	28"Lx28"Wx46"H	178

OPTIONS		OPTIONS	
PART NO.	DESCRIPTION	PART NO.	DESCRIPTION
2.642-305.0	Gutter cleaning lance	6.390-028.0	Pipe cleaning hose
4.760-245.0	Underbody lance	4.762-010.0	Wet blasting attachment
9.112-508.0	21" wand with quick connect female threads	2.638-526.0	Nozzle kit for wet blasting attachment
9.112-533.0	21" wand with quick connect male threads	2.640-482.0	Nozzle kit for surface cleaner FR
6.389-479.0	High-pressure hose, 10m DN8, extension piece	2.883-803.0	Power nozzle 25° spray angle
4.767-001.0	Triple nozzle, touchless changeover	4.767-230.0	Dirtblaster nozzle 035
4.767-022.0	Dirtblaster, small	3.637-170.0	Detergent injector for high pressure
4.775-526.0	Servo-press controller, less than 303 GPM		
6.401-459.0	Plug nipple		

500 SERIES

and Model 680SS

- Oil-Fired or LP-Fired
- 115V/1PH
- 1725 RPM Direct-Drive Pump
- Flat Free Tires for Easy Handling



Model 555SS



Model 558-Propane
(Shown with optional Portagear
& Propane Tank)



Model 560SS



Model 680SS

The **500 Series** delivers rugged, yet affordable, cleaning power for a broad range of applications, from agriculture to building maintenance. The sporty 555SS, with its stainless steel coil skin, is our most popular entry level hot water model—compact, evenly balanced, easy to maneuver, and engineered with the operator in mind. As with the entire Hotsy line, all models in the 500 series are ETL safety certified to UL-1776, with Hotsy pumps backed by a 7-year limited warranty. A pressure relief valve is standard on all 500 Series models. Equipped with a 50' hose.

MODEL	PART NO.	GPM	PSI	HP	VOLT/PH	AMPS	FUEL	BTU/HR	PUMP MODEL	PORTABILITY	DIMENSIONS	SHIP WT (lbs)
555SS	1.109-033.0	2.2	1300	2	115/1	20	Oil	214,300	Duplex - HHC165L.1	Std	33"Lx27"Wx41.5"H	360
558	1.109-610.0	2.2	1300	2	115/1	18	LP	214,300	Duplex - HHC165L.1	Optional	31.5"Lx26"Wx41"H	350
560SS	1.109-034.0	2.1	1500	2.3	115/1	20	Oil	214,300	Triplex - HHC205L.1	Std	33"Lx26"Wx44"H	395
680SS	1.109-035.0	3.0	1000	2	115/1	20	Oil	289,900	Triplex - HF2830S	Std	33"Lx27"Wx45.5"H	405

SS=Stainless Steel

OPTIONS		OPTIONS	
PART NO.	DESCRIPTION	PART NO.	DESCRIPTION
8.717-728.0	8" LP Gas-Fired Draft Diverter (Model 558)	8.717-791.0	Propane Tank, 43 lb. (Model 558)
8.717-764.0	8" Oil-Fired Vent Regulator (Models 555SS, 560SS & 680SS)	8.903-034.0	Float Tank, 555SS (Field Install)
8.903-049.0	Portagear, Model 558	8.750-486.0	360° Pivot Reel, 100' (fits all 500 Series EXCEPT 558)

700 SERIES

and Model 895SS

- Oil-Fired, LP- or Natural-Gas-Fired
- Direct- & Belt-Drive
- Flat Free Tires for Easy Handling



The 700 Series offers a nice balance of Hotsy ruggedness and cleaning performance, yet the affordability of an entry-level machine. In addition to the two direct-drive models, this series also offers belt-drive models that clean at 3.0 GPM and 2000 PSI. More powerful yet is the 895SS. The multiple fuel and electrical options makes the 700 series ideal for meeting the needs of commercial customers. All models are ETL safety certified and feature the Hotsy Triplex pump with a 7-year limited warranty. A pressure relief valve is standard on all 700 Series models. Equipped with a 50' hose.

MODEL	PART NO.	GPM	PSI	HP	VOLT/PH	AMPS	FUEL	BTU/HR	PUMP MODEL	DRIVE	PORTABILITY	DIMENSIONS	SHIP WT (lbs)
771	1.109-611.0	3.0	1500	3	230/1	13	LP	280,000	HHC235R.1	Direct	Optional	32"Lx27"Wx45.5"H	415
772	1.109-037.0	3.0	1500	3	230/1	13	NG	338,000	HHC235R.1	Direct	N/A	32"Lx27"Wx45.5"H	415
790SS	1.109-612.0	3.0	2000	4TEFC	230/1	20	Oil	289,900	HB4025R	Belt	Std	37"Lx28"Wx45.5"H	450
795SS	1.109-039.0	3.5	2000	5	230/1	24	Oil	289,900	HB4025R	Belt	Std	37"Lx28"Wx45.5"H	455
795SS-208	1.109-040.0	3.5	2000	5	208/1	27	Oil	289,900	HB4025R	Belt	Std	37"Lx28"Wx45.5"H	500
895SS	1.109-077.0	3.5	3000	8.2	230/1	36	Oil	289,900	HHC506R.1	Belt	Std	37"Lx28"Wx45.5"H	480

SS=Stainless Steel

OPTIONS	
PART NO.	DESCRIPTION
8.717-728.0	8" Natural Gas- or LP Gas-Fired Draft Diverter (Models 771, 772)
8.717-764.0	8" Oil-Fired Vent Regulator (Models 790SS, 795SS & 895SS)
8.903-049.0	Portagear, Model 771

OPTIONS	
PART NO.	DESCRIPTION
8.717-791.0	Propane Tank, 43 lb.
8.750-486.0	360° Pivot Reel, 100'
8.750-483.0	360° Pivot Reel, 200' (fits all models EXCEPT 771, 772)

800 SERIES

- Oil-Fired
- Big & Beefy, Yet Easy To Maneuver
- Rugged Hotsy Pump with 7-Year Limited Warranty
- Stainless-Steel Coil Skin



The 800 Series - rugged design, easy maneuverability and massive cleaning power. Comparable to the cleaning power of Hotsy's heavy-duty stationary units, the big and beefy 800 Series is surprisingly easy to maneuver into place, allowing you to tackle the heaviest of industrial cleaning jobs. The 28" wide wheel base helps with stability, yet is narrow enough to fit easily through doorways. Components are protected by an easy-to-remove cover allowing servicing access. All 800 series hot water pressure washers are backed by a 7-year limited warranty on the Hotsy Triplex pump. A pressure relief valve, upstream detergent injector and stainless steel coil wrap are standard features on all 800 Series models, which are ETL certified. Equipped with a 50' hose.

U.S. Design Patent No. 726,382 S



MODEL	PART NO.	GPM	PSI	HP	MOTOR RPM	VOLT/PH	AMPS	FUEL	BTU/HR	PUMP MODEL	DRIVE	PORTABILITY	DIMENSIONS	SHIP WT (lbs)
821	1.109-120.0	4.0	2300	6.2	3450	208/1	33	Oil	381,000	HM4045R.3	Belt	Std	51"Lx28"Wx51"H	632
842	1.109-121.0	4.0	2000	5	1725	208/3	20	Oil	381,000	HM4030R.3	Belt	Std	51"Lx28"Wx51"H	622
843	1.109-122.0	4.0	2000	5	1725	230/1	29	Oil	381,000	HM4030R.3	Belt	Std	51"Lx28"Wx51"H	622
844	1.109-123.0	4.0	2000	5	1725	230/3	19	Oil	381,000	HM4030R.3	Belt	Std	51"Lx28"Wx51"H	622
845	1.109-124.0	4.0	2000	5	1725	460/3	10	Oil	381,000	HM4030R.3	Belt	Std	51"Lx28"Wx51"H	691
851	1.109-125.0	4.0	3000	8.2	3450	208/1	44	Oil	381,000	HM4045R.3	Belt	Std	51"Lx28"Wx51"H	675
852	1.109-126.0	4.0	3000	7.5	1725	208/3	25	Oil	381,000	HM4030R.3	Belt	Std	51"Lx28"Wx51"H	665
853	1.109-127.0	4.0	3000	7.5	1725	230/1	37	Oil	381,000	HM4030R.3	Belt	Std	51"Lx28"Wx51"H	665
854	1.109-128.0	4.0	3000	7.5	1725	230/3	25	Oil	381,000	HM4030R.3	Belt	Std	51"Lx28"Wx51"H	665
855	1.109-129.0	4.0	3000	7.5	1725	460/3	14	Oil	381,000	HM4030R.3	Belt	Std	51"Lx28"Wx51"H	665
856	1.109-130.0	4.0	3000	8.2	3450	575/3	11	Oil	381,000	HM4045R.3	Belt	Std	51"Lx28"Wx51"H	680
873	1.109-131.0	5.0	3000	10	1725	230/1	42	Oil	404,000	HM4030R.3	Belt	Std	51"Lx28"Wx51"H	670
874	1.109-132.0	5.0	3000	10	1770	230/3	29	Oil	404,000	HM4030R.3	Belt	Std	51"Lx28"Wx51"H	675

OPTIONS	
PART NO	DESCRIPTION
8.930-170.0	Auto Start/Stop Kit (Field Installed)*
8.930-172.0	Thermal Shutdown Kit (Field Installed)
8.930-171.0*	Time Delay Shutdown (Field Installed)*
8.717-764.0	8" Oil-Fired Vent Regulator

OPTIONS	
PART NO	DESCRIPTION
8.750-486.0	360° Pivot Reel, 100'
8.750-483.0	360° Pivot Reel, 200'
8.711-907.0	Pneumatic Wheel - 12 1/2" (4 required)
8.923-225.0	Detergent Bucket Bracket

* Note: Time Delay Shutdown and Auto Start/Stop cannot be combined on the same machine

900/1400 SERIES



- LP-or Natural Gas-Fired
- Belt-Drive Hotsy Pump
- Smart Relay Control provides control over run time, auto start/stop and shut down functionality
- Remote Ready

The 900/1400 Series - Hotsy's innovative stationary models are packed with standard features! The most impressive is the programmable smart control automation. Safety is key with a pressure relief valve and locking lid and side panels around the belt and pulleys to keep users safe. These electric-powered washers are available in either LP or Natural Gas fired models. New models have the same footprint as previous generations, so users can feel confident about upgrading. Panels may be easily removed for access to the machine components for servicing. All models are ETL certified to the rigid UL-1776 safety standards. Features a Hotsy highly efficient Triplex pump. Equipped with a 50' hose.

U.S. Design Patent No. 740,501 S



MODEL	PART NO.	GPM	PSI	HP	MOTOR RPM	VOLT/PH	AMPS	FUEL	BTU/HR	PUMP MODEL	DRIVE	DIMENSIONS	SHIP WT (lbs)
921P	1.109-948.0	4.0	2300	6.2	3450	208/1	28	LP	364,835	HM4030R.3	Belt	47.5"Lx21"Wx51"H*	700
921N	1.109-691.0	4.0	2300	6.2	3450	208/1	28	NG	364,835	HM4030R.3	Belt	47.5"Lx21"Wx51"H*	700
926P	1.109-949.0	4.0	2000	5	1800	575/3	7	LP	364,835	HM4030R.3	Belt	47.5"Lx21"Wx51"H*	660
926N	1.109-692.0	4.0	2000	5	1800	575/3	7	NG	364,835	HM4030R.3	Belt	47.5"Lx21"Wx51"H*	660
942P	1.109-693.0	4.0	2000	5	1725	208/3	18	LP	360,997	HM4030R.3	Belt	47.5"Lx21"Wx51"H*	590
942N	1.109-694.0	4.0	2000	5	1725	208/3	18	NG	364,835	HM4030R.3	Belt	47.5"Lx21"Wx51"H*	655
943P	1.109-695.0	4.0	2000	5	1725	230/1	25	LP	360,997	HM4030R.3	Belt	47.5"Lx21"Wx51"H*	685
943N	1.109-696.0	4.0	2000	5	1725	230/1	25	NG	364,835	HM4030R.3	Belt	47.5"Lx21"Wx51"H*	685
944P	1.109-697.0	4.0	2000	5	1725	230/3	16	LP	360,997	HM4030R.3	Belt	47.5"Lx21"Wx51"H*	580
944N	1.109-698.0	4.0	2000	5	1725	230/3	16	NG	364,835	HM4030R.3	Belt	47.5"Lx21"Wx51"H*	680
945P	1.109-699.0	4.0	2000	5	1725	460/3	8	LP	360,997	HM4030R.3	Belt	47.5"Lx21"Wx51"H*	585
945N	1.109-700.0	4.0	2000	5	1725	460/3	8	NG	364,835	HM4030R.3	Belt	47.5"Lx21"Wx51"H*	585
1451P	1.109-950.0	3.5	3000	7.5	3450	208/1	42	LP	364,835	HM4030R.3	Belt	47.5"Lx21"Wx51"H*	730
1451N	1.109-701.0	3.5	3000	7.5	3450	208/1	42	NG	364,835	HM4030R.3	Belt	47.5"Lx21"Wx51"H*	730
1452P	1.109-702.0	3.5	3000	7.5	1725	208/3	24	LP	360,997	HM4030R.3	Belt	47.5"Lx21"Wx51"H*	625
1452N	1.109-703.0	3.5	3000	7.5	1725	208/3	24	NG	364,835	HM4030R.3	Belt	47.5"Lx21"Wx51"H*	625
1453P	1.109-704.0	3.5	3000	7.5	1725	230/1	34	LP	360,997	HM4030R.3	Belt	47.5"Lx21"Wx51"H*	735
1453N	1.109-705.0	3.5	3000	7.5	1725	230/1	34	NG	364,835	HM4030R.3	Belt	47.5"Lx21"Wx51"H*	735
1454P	1.109-706.0	3.5	3000	7.5	1725	230/3	24	LP	360,997	HM4030R.3	Belt	47.5"Lx21"Wx51"H*	625
1454N	1.109-707.0	3.5	3000	7.5	1725	230/3	24	NG	364,835	HM4030R.3	Belt	47.5"Lx21"Wx51"H*	700
1455P	1.109-708.0	3.5	3000	7.5	1725	460/3	12	LP	360,997	HM4030R.3	Belt	47.5"Lx21"Wx51"H*	630
1455N	1.109-709.0	3.5	3000	7.5	1725	460/3	12	NG	364,835	HM4030R.3	Belt	47.5"Lx21"Wx51"H*	780
1456P	1.109-951.0	3.5	3000	8.2	3450	575/3	10	LP	364,835	HM4030R.3	Belt	47.5"Lx21"Wx51"H*	621
1456N	1.109-710.0	3.5	3000	8.2	3450	575/3	10	NG	364,835	HM4030R.3	Belt	47.5"Lx21"Wx51"H*	621
1473P	1.109-711.0	5.0	3000	10	1725	230/1	42	LP	378,617	HM4035R.3	Belt	47.5"Lx21"Wx51"H*	735
1473N	1.109-713.0	5.0	3000	10	1725	230/1	42	NG	390,025	HM4035R.3	Belt	47.5"Lx21"Wx51"H*	735
1474P	1.109-712.0	5.0	3000	10	1770	230/3	29	LP	378,617	HM4035R.3	Belt	47.5"Lx21"Wx51"H*	740
1474N	1.109-714.0	5.0	3000	10	1770	230/3	29	NG	390,025	HM4035R.3	Belt	47.5"Lx21"Wx51"H*	740
1475P	1.109-952.0	5.0	3000	10	1725	208/3	32	LP	378,617	HM4030R.3	Belt	47.5"Lx21"Wx51"H*	740
1475N	1.109-953.0	5.0	3000	10	1725	208/3	32	NG	378,617	HM4030R.3	Belt	47.5"Lx21"Wx51"H*	740

* including connectors and flue outlet

OPTIONS	
PART NO	DESCRIPTION
8.916-989.0	Remote Station
8.916-988.0	Soap Solenoid and Switch
8.717-728.0	8" Natural Gas- or LP Gas-Fired Draft Diverter
8.903-543.0	Wheel Kit with LP Bottle Rack
9.803-452.0	Water Inlet Solenoid (Field Installed)
8.755-253.0	8" Power Dampener
8.749-807.0	Power Dampener Wiring Harness
8.924-814.0	R-Con Wireless Remote Kit (1 remote/1 receiver)

OPTIONS	
PART NO	DESCRIPTION
8.925-072.0	R-Con Wireless Remote Kit (2 remote/1 receiver)
8.924-878.0	Wall Mount Remote Bracket for R-Con
8.756-329.0	Replacement Remote (transmitter only)



1800 SERIES

- Natural Gas, Oil or optional LP-Fired
- Belt Drive Pump
- Smart Relay Control provides control over run time, auto start/stop and shut down functionality



The **1800 Series** provides stationary cleaning with hot water indoors. The 7 models are electric-powered and natural gas, oil or optional LP gas-heated. The coil skin comes standard with stainless steel. The sleek cabinet has removeable side and front panels, making it easy for routine scheduled maintenance and service. The Smart Relay allows the washer to be customized to individual needs, and is protected behind the front panel. All models are certified to the rigid UL-1776 safety standards and feature the highly efficient Hotsy Triplex pump. A pressure switch is a standard feature on all 1800 Series models. Equipped with a 50' hose.



MODEL	PART NO.	GPM	PSI	HP	VOLT/PH	AMPS	FUEL	BTU/HR	PUMP MODEL	DRIVE	DIMENSIONS	SHIP WT (lbs)
1812SS	1.109-660.0	6.0	2500	10	230/1	42	NG	558,050	HX9536L.2	Belt	51"Lx31"Wx53.25"H	1,020
1830SS	1.109-665.0	6.0	3000	15	230/3	35	Oil*	579,776	HX9536L.2	Belt	51"Lx31"Wx53.25"H	1,020
1832SS	1.109-662.0	6.0	3000	15	230/3	33	NG	558,050	HX9536L.2	Belt	51"Lx31"Wx53.25"H	1,020
1832SS-208	1.109-661.0	6.0	3000	15	208/3	36	NG	558,050	HX9536L.2	Belt	51"Lx31"Wx53.25"H	1,020
1833SS	1.109-666.0	6.0	3000	15	460/3	21	Oil*	579,776	HX9536L.2	Belt	51"Lx31"Wx53.25"H	1,020
1835SS	1.109-663.0	6.0	3000	15	460/3	19	NG	558,050	HX9536L.2	Belt	51"Lx31"Wx53.25"H	1,020
1836SS	1.109-664.0	6.0	3000	15	575/3	16	NG	558,050	HX9536L.2	Belt	51"Lx31"Wx53.25"H	1,020

SS=Stainless Steel *Oil-Fired models are not supplied with a fuel tank.

OPTIONS	
PART NO.	DESCRIPTION
8.916-989.0	Remote Station
8.916-988.0	Soap Solenoid and Switch
8.749-806.0	10" Power Dampener
8.749-807.0	Power Dampener Wiring Harness
8.903-074.0	LP Conversion Kit (Factory Installed)
9.801-040.0	10" Natural Gas- or LP Gas-Fired Draft Diverter

OPTIONS	
PART NO.	DESCRIPTION
8.803-452.0	Water Inlet Solenoid (Field Installed)
8.924-814.0	R-Con Wireless Remote Kit (1 remote/1 receiver)
8.925-072.0	R-Con Wireless Remote Kit (2 remotes/1 receiver)
8.924-878.0	Wall Mount Remote Bracket for R-Con
8.756-329.0	Replacement Remote (transmitter only)



5700/5800 SERIES

- Oil, Natural Gas or optional LP-Fired
- Belt Drive Pump
- Smart Relay Control provides control over run time, auto start/stop and shut down functionality



The **5700 and 5800 Series** produces a powerful punch and is ideal for wash bay installations. With its 20 HP motor driving the incomparable Hotsy Triplex Pump and a vertical banded belt, the 5700 and 5800 Series delivers cleaning power up to 9.5 GPM and 3000 PSI. Has a sleek cabinet with removeable panels for easy access for maintenance. A removeable control panel provides access to the adjustable temperature control and the Smart Relay for secured control of operating positions. Remote ready for wash bay installations. All models are stationary and certified to the rigid UL-1776 safety standards. Equipped with a 50' hose.



MODEL	PART NO.	GPM	PSI	HP	VOLT/PH	AMPS	FUEL	BTU/HR	PUMP MODEL	HOSE	SHIP WT
5730SS	1.109-658.0	8.0	3000	20	230/3	44	Oil*	768,000	HX9536L.2	50'	1,471
5732SS-208	1.109-654.0	8.0	3000	20	208/3	55	NG	720,450	HX9536L.2	50'	1,471
5732SS	1.109-655.0	8.0	3000	20	230/3	42	NG	720,450	HX9536L.2	50'	1,471
5733SS	1.109-659.0	8.0	3000	20	460/3	23	Oil*	768,000	HX9536L.2	50'	1,471
5735SS	1.109-656.0	8.0	3000	20	460/3	21	NG	720,450	HX9536L.2	50'	1,471
5736SS	1.109-657.0	8.0	3000	20	575/3	16	NG	720,450	HX9536L.2	50'	1,471
5832SS	1.109-651.0	9.5	2500	20	230/3	42	NG	939,890	HX1036L.2	50'	1,471
5832SS-208	1.109-650.0	9.5	2500	20	208/3	48	NG	939,890	HX1036L.2	50'	1,471
5835SS	1.109-652.0	9.5	2500	20	460/3	21	NG	939,890	HX1036L.2	50'	1,461
5836SS	1.109-653.0	9.5	2500	20	575/3	16	NG	939,890	HX1036L.2	50'	1,471

SS=Stainless Steel Dimensions: 51"L x 31"W x 63.4"H *Oil-Fired models are not supplied with a fuel tank.

OPTIONS	
PART NO.	DESCRIPTION
8.916-916.0	LP Conversion Kit, 5700 (Factory Installed)
8.916-915.0	LP Conversion Kit, 5800 (Factory Installed)
8.753-171.0	12" Power Dampener
8.749-807.0	Power Dampener Wiring Harness
9.803-452.0	Water Inlet Solenoid (Factory Installed)
8.916-989.0	Remote Station

OPTIONS	
PART NO.	DESCRIPTION
8.916-988.0	Soap Solenoid and Switch
8.717-730.0	12" Natural Gas- or LP Gas-Fired Draft Diverter
8.924-814.0	R-Con Wireless Remote Kit (1 remote/1 receiver)
8.925-072.0	R-Con Wireless Remote Kit (2 remotes/1 receiver)
8.924-878.0	Wall Mount Remote Bracket for R-Con
8.756-329.0	Replacement Remote (transmitter only)



GAS-ENGINE SERIES

DIRECT-DRIVE

- Oil-Fired
- 12 Volt DC
- Direct Drive
- 3 Battery-less Models
- 2 Electric-Start Models
- Flat Free Tires for Easy Handling



965SS



1065SSE

The Gas Engine Series consists of the most compact and portable hot water pressure washers on the market. Powered by reliable gasoline engines, all you need is water and you can clean anywhere anytime. The five models offer a broad range of cleaning power, from 3.0 to 4.0 GPM and from 3000 to 3500 PSI. All models feature Hotsy's highly efficient Triplex pump backed by Hotsy's 7-year pump limited warranty and all are ETL safety certified. All models are equipped with a standard pressure switch and 50' hose.



MODEL	PART NO.	GPM	PSI	ENGINE / MODEL	CC's	BURNER	BTU/HR	PUMP MODEL	DRIVE	PORTABILITY	DIMENSIONS	SHIP WT (lbs)
965SS*	1.110-015.0	3.0	3000	Honda GX270	270	12V DC	248,500	HG3035G1.1	Direct	Std	47"Lx31"Wx41"H	445
1065SS*	1.110-010.0	3.5	3000	Honda GX340	337	12V DC	309,900	HS3540G.3	Direct	Std	47"Lx31"Wx45"H	495
1065SSE†	1.110-011.0	3.5	3000	Honda GX340	337	12V DC	309,900	HS3540G.3	Direct	Std	47"Lx31"Wx45"H	510
1075SSE†	1.110-012.0	4.0	3500	Honda GX390	389	12V DC	309,900	HS4040G.3	Direct	Std	47"Lx31"Wx45"H	520

* Battery not required † 12V battery required, but not supplied E= Electric-start engine

GAS-ENGINE SERIES

BELT-DRIVE

- Oil-Fired
- 12 Volt DC
- Belt Drive
- 2 Electric-Start Models



1075BE (Shown with optional caster wheel kit)



965B (Shown with optional pneumatic tires)



1080BE (Shown with optional stainless steel coil wrap and skid rails)

The belt-drive versions of the Gas Engine Series provide versatility with the roll cage design. Designed to fit the needs of the end-user, this versatile hot water washer converts easily to a skid unit, portable with wheels or a wheel/caster kit, or can be mounted on a trailer. Powered by reliable gasoline engines, the three models offer a broad range of cleaning power, from 3.0 to 4.6 GPM and from 3000 to 3500 PSI. All models feature the Hotsy Triplex pump backed by Hotsy's 7-year pump limited warranty and all are ETL safety certified. All models are equipped with a standard pressure switch and 50' hose.



MODEL	PART NO.	GPM	PSI	ENGINE / MODEL	CC's	BURNER	BTU/HR	PUMP MODEL	DRIVE	PORTABILITY	DIMENSIONS	SHIP WT (lbs)
965B*	1.110-565.0	3.0	3000	Honda GX270	270	12V DC	248,500	HD3030L.1	Belt	Optional	42"Lx27.5"Wx39"H	590
1075BE†	1.110-566.0	4.0	3500	Honda GX390	389	12V DC	385,800	HM4035L.3	Belt	Optional	42"Lx27.5"Wx39"H	625
1080BE†	1.110-567.0	4.6	3500	Briggs VAN 18	570	12V DC	385,800	HM4035L.3	Belt	Optional	42"Lx27.5"Wx39"H	665

* Battery not required † 12V battery required, but not supplied E= Electric-start engine B= Belt Drive

OPTIONS

PART NO.	DESCRIPTION
8.916-172.0	Float Tank Kit (includes high pressure detergent kit), 1075BE & 1080BE models
8.916-173.0	Float Tank Kit (includes high pressure detergent kit) 965B model
8.931-259.0	Skid Rail Kit (Field Installed)- adds 3.875" to height
8.931-260.0	Caster Kit - 2 casters / 2 wheels (Field Installed) - adds 7.5" to height
8.931-261.0	Pneumatic Tire Kit with Handle Bar (Field Installed) - adds 10" to width, 6" to height
8.916-175.0	High Pressure Detergent Kit, 1075BE & 1080BE models (to be used with a remote water tank)
8.916-174.0	High Pressure Detergent Kit, 965B models (to be used with a remote water tank)
8.915-274.0	Stainless Steel Coil Wrap (Field Installed)

1200 SERIES

and Model 5645

- Gas/Diesel-Powered
- Oil-Fired
- Belt Drive
- Electric Start



1260SS



1270SS
Shown
with
optional
Portagear
Kit



5645

The **1200 Series** delivers some serious on-site, hot water cleaning capability of up to 6 GPM and 4000 PSI. Rugged gasoline engines all have electric start. Six models come with a 2000W generator. The self-contained cleaning units are built to hold up under the toughest of conditions. All feature the Hotsy Triplex pump, with its 7-year limited warranty and ETL safety certification (CSA-Certified for non-generator models). All 1200 Series models are equipped with a standard flow switch and 50' hose.



MODEL	PART NO.	GPM	PSI	ENGINE / MODEL	FUEL	CC's	BURNER	BTU/HR	PUMP MODEL	DRIVE	DIMENSIONS	SHIP WT (lbs)
1260SS	1.110-533.0	4.5	3000	Briggs VAN 18	Gas	570	12V DC	385,800	HM4035R.2	Belt	45"Lx33"Wx52"H	745
1260SSG*	1.110-535.0	4.5	3000	Briggs VAN 18	Gas	570	120V AC	398,400	HM4035R.2	Belt	45"Lx33"Wx52"H	830
1270SS	1.110-557.0	4.5	4000	Honda GX630	Gas	688	12V DC	385,800	HX5843R.2	Belt	45"Lx33"Wx52"H	855
1270SSG*	1.110-536.0	4.5	4000	Honda GX630	Gas	688	120V AC	398,400	HX5843R.2	Belt	45"Lx33"Wx52"H	870
1280SS	1.110-558.0	5.1	3500	Honda GX630	Gas	688	12V DC	385,800	HX8043R.2	Belt	45"Lx33"Wx52"H	760
1280SSG*	1.110-537.0	5.1	3500	Honda GX630	Gas	688	120V AC	398,400	HX8043R.2	Belt	45"Lx33"Wx52"H	750
1285SS	1.110-043.0	5.1	3500	Briggs VAN 21	Gas	627	12V DC	385,800	HX8043R.2	Belt	45"Lx33"Wx52"H	840
1285SSG*	1.110-044.0	5.1	3500	Briggs VAN 21	Gas	627	120V AC	398,400	HX8043R.2	Belt	45"Lx33"Wx52"H	895
1290SS	1.110-538.0	5.6	3000	Honda GX630	Gas	688	12V DC	385,800	HX8043R.2	Belt	45"Lx33"Wx52"H	744
1290SSG*	1.110-539.0	5.6	3000	Honda GX630	Gas	688	120V AC	398,400	HX8043R.2	Belt	45"Lx33"Wx52"H	905
1291SS	1.110-075.0	8.0	3000	Honda GX660	Gas	688	12V DC	385,800	HX9536R	Belt	45"Lx33"Wx52"H	760
1291SSG*	1.110-076.0	8.0	3000	Honda GX660	Gas	688	120V AC	398,400	HX9536R	Belt	45"Lx33"Wx52"H	920
1265SSD	1.110-073.0	4.5	3000	Kubota Z602-E4B	Diesel	599	12V DC	385,800	HM4035	Belt	45"Lx33"Wx52"H	795
1265SSDS**	1.110-074.0	4.5	3000	Kubota Z602-E4B	Diesel	599	12V DC	385,800	HM4035	Belt	45"Lx33"Wx52"H	795
5645*	1.110-556.0	6.0	3000	Honda GX660	Gas	688	120V AC	528,000	HX8043R.2	Belt	61"Lx32"Wx50"H	1126

* Models include a 2000W Generator **Models include stainless frame
12V battery is required for all models, but is not supplied

OPTION

PART NO.	DESCRIPTION
8.903-025.0	Portagear Kit (all models except 5645)

Super Skid HSS SERIES & HSDS SERIES

- Diesel-Powered
- Diesel-Fired
- Belt Drive
- Electric-Start



The Super Skid HSS Series is by far, the largest, most powerful of Hotsy's hot water pressure washers. The Super Duty HSDS models feature a Hawk pump with lower RPM for long lasting durability; there's literally nothing else on the market as robust, big & powerful. HSS models come standard with the reliable Hotsy triplex belt-driven high-pressure pump. Triple banded belt for more efficient power transmission. Models are powered by a 16 & 24 HP Kubota engines with electric start and all feature a 3/4-inch foil-backed insulated Schedule 80 heating coil with stainless steel skin and 5-year warranty. Two fuel tanks for longer operation, a high-efficiency Wayne burner and optional dual gun kit allows two users at one time.



MODEL	PART NO.	GPM	PSI	ENGINE / MODEL	CC's	BURNER	BTU/HR	PUMP MODEL	HOSE	DIMENSIONS	SHIP WT (lbs)
HSS-503069E	1.110-604.0	5.0	3000	Kubota Z602-E4B	599	12V DC	429,000	HX5843R.2	50'-3/8"	73"Lx37"Wx64"H	1305
HSS-653569E	1.110-605.0	6.5	3500	Kubota D1105-E4B	1123	12V DC	557,000	HX8043R.2	50'-3/8"	73"Lx37"Wx64"H	1710
HSS-803069E	1.110-606.0	8.0	3000	Kubota D1105-E4B	1123	12V DC	772,000	HX9536.2	50'-1/2"	73"Lx37"Wx64"H	1715
HSS-952569E	1.110-607.0	9.5	2500	Kubota D1105-E4B	1123	12V DC	857,000	HX1036R.2	50'-1/2"	73"Lx37"Wx64"H	1715

SUPER DUTY MODELS:

MODEL	PART NO.	GPM	PSI	ENGINE / MODEL	CC's	BURNER	BTU/HR	PUMP MODEL	HOSE	DIMENSIONS	SHIP WT (lbs)
HSDS-503069E	1.110-616.0	5.0	3000	Kubota Z602-E4B	599	12V DC	429,000	HHP2750R	50'-3/8"	73"Lx37"Wx64"H	1610
HSDS-653569E	1.110-617.0	6.5	3500	Kubota D1105-E4B	1123	12V DC	557,000	HHP3650R	50'-3/8"	73"Lx37"Wx64"H	2005
HSDS-803069E	1.110-618.0	8.0	3000	Kubota D1105-E4B	1123	12V DC	772,000	HFR40FR	50'-1/2"	73"Lx37"Wx64"H	2015
HSDS-952569E	1.110-619.0	9.5	2500	Kubota D1105-E4B	1123	12V DC	857,000	HFR60FR	50'-1/2"	73"Lx37"Wx64"H	2020

All Models are Electric Start. 12V battery is required for all models, but is not supplied

OPTIONS

PART NO.	DESCRIPTION
8.923-164.0	Dual Gun Kit - includes necessary fittings, extra hose gun and wand (Field installed)
8.923-125.0	Steam Kit - includes necessary fittings and panel mount control valve (Field installed)
8.923-124.0	Float Tank Kit - includes float tank, necessary fittings and panel mount detergent metering valve (Field installed)

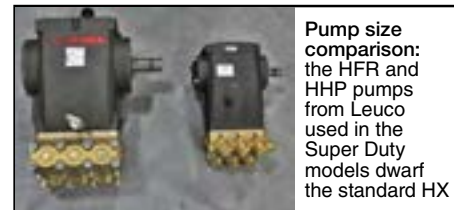

HWE SERIES

All Electric Models

- All Electric
- Belt Drive
- Auto/Start Stop
- Stainless Steel Coil



The HWE Series is powered and heated by electricity, making it ideal for indoor use. It's a quiet machine with no fumes, making it ideal for food service and in-plant cleaning. Water is heated in a stainless steel heating coil, immersed in a tank of water solution, allowing for instant hot water once you pull the trigger. The heating elements do not come in contact with the pressurized water, which results in less maintenance and minimizes scale build up. The HWE features a Baldor motor, which drives a belt-drive Hotsy Triplex pump, with 7-year limited warranty, and an insulated variable pressure wand. ETL certified. Float switch is standard on the HWE Series. All models equipped with a 50' hose.



MODEL	PART NO.	GPM	PSI	HP	MOTOR	AMPS	VOLT/PH	KvA HOUR	BTU/HR	PUMP MODEL	DRIVE	DIMENSIONS	SHIP WT (lbs)
HWE-402009C	1.109-646.0	4.0	2000	6.2	Baldor	55	460/3	40.5	138,308	HM4030R.3	Belt	34"Lx25"Wx52"H	620
HWE-403009C	1.109-647.0	3.5	3000	7.5	Baldor	59	460/3	40.5	138,308	HM4030R.3	Belt	34"Lx25"Wx52"H	640
HWE-402009F	1.109-958.0	3.5	2000	5	Baldor	46	575/3	40.5	138,308	HM4030R.3	Belt	34"Lx25"Wx52"H	620
HWE-403009F	1.109-959.0	3.5	3000	7.5	Baldor	49	575/3	40.5	138,308	HM4030R.3	Belt	34"Lx25"Wx52"H	640

OPTIONS

PART NO.	DESCRIPTION
8.903-042.0	Stainless Steel Washer Wrap 1700 Series (Factory installed)
8.725-157.0	Option, Time Delay Shutdown HWE-402009C (Factory installed)*
8.725-158.0	Option, Time Delay Shutdown HWE-403009C (Factory installed)*

*Note: Time Delay Shutdown and Auto Start/Stop cannot be combined on the same machine

9400 SERIES Heating Modules

The **9400 Series** heating modules give customers the flexibility to “convert” a cold water pressure washer into a hot water unit. By attaching the heating module to a cold water pressure washer the pressurized water is now heated to produce all the benefits of hot water cleaning. The four models use fuel oil, diesel or natural gas to heat the water using Hotsy’s high-efficiency, vertical heating coil. All models are equipped with a flow switch to control the burner.



Model 9462



Model 9452



MODEL	PART NO.	PSI (Max)	GPM (Max)	GPM (Min)	VOLT/PH	BTU/HOUR	AMP	FUEL	DIMENSIONS	SHIP WT (lbs)
9450	1.103-905.0	3200	10	6	115/1	700,000	8	Oil-Fired	32.5”Lx25”Wx50.5”H	525
9452	1.103-906.0	3200	10	6	115/1	540,000	1	Natural-Gas-Fired	32.5”Lx25”Wx50.5”H	500
9460	1.103-907.0	3200	10	6	115/1	920,000	8	Oil-Fired	40.5”Lx32”Wx65”H	920
9462	1.103-908.0	3200	10	6	115/1	920,000	1	Natural-Gas-Fired	40.5”Lx32”Wx65”H	935

OPTIONS	
PART NO.	DESCRIPTION
8.903-076.0	Natural-Gas to LP Conversion for Model 9452 (Factory Installed)
8.903-075.0	Natural-Gas to LP Conversion for Model 9462 (Factory Installed)
9.801-040.0	10” Natural Gas-Fired Draft Diverter for Model 9452
8.717-730.0	12” Natural Gas-Fired Draft Diverter for Model 9462
8.749-806.0	10” Power Dampener
8.753-171.0	12” Power Dampener
8.749-807.0	Power Dampener Wiring Harness

Fuel-burner types available:

- Diesel ■ Kerosene ■ Home Heating Oil
- Natural Gas ■ LP Gas (Optional)

Trail Blazer TRAILER

- 200 Gallon Water Tank
- Single axle rated to 3500 pounds
- Swing Away Hinged Tongue
- Electric Brakes



Shown with 1080BE and optional accessories

The **Trail Blazer** is Hotsy’s affordable trailer solution that provides mobile cleaning anywhere. Axle assembly with leaf-spring suspension is rated at 3,500 lbs. The heavy duty-chassis features a swing-away hinge with swivel jack tongue assembly. The 200 gallon water tank features a float valve and 7-inch access port. 15-inch white spoke wheel assembly. Axle with electric brakes and break-away kit is the standard configuration.

Select a trailer and add one of these pressure washer models:

- 965B
- 1075BE
- 1080BE
- 1200 Series

MODEL	PART NO.	GVWR	WATER TANK CAPACITY	GAWR	WHEELS	JACK	JACK CAPACITY	BALL COUPLER	SAFETY CHAINS	LIGHTING
TRB-3500	1.103-818.0	3500 lbs	200 gal	Single 3500 lbs	15” White Spoke Wheels ST205/75D15 Tires	Swivel Wheel w/Caster Foot	1000 lbs	2”	Dual 5/16”	Recessed Lights are DOT approved

Trailer Dimensions 136” L x 66” W x 52” H

Trailer Weight: 543 lbs.

Shipping Weight: 1043 lbs. (does not include pressure washer)

OPTIONS (FACTORY INSTALLED)	
PART NO.	DESCRIPTION
8.917-398.0	Brakes, Hydraulic
8.917-554.0	High Pressure Hose Reel
8.917-555.0	Low Pressure Hose Reel
8.917-556.0	Saddle Box Kit, set of two
8.917-557.0	Rock Guard Kit
8.917-583.0	Chrome Wheel Rims
8.924-493.0	2-5/16” Ball Hitch Coupler (adjustable height)
8.904-051.0	Battery Installed on Pressure Washer

OPTIONS (FACTORY INSTALLED)	
PART NO.	DESCRIPTION
8.917-290.0	Assembly Mounting (for 1200 Series)*
8.917-291.0	Assembly Mounting (for 965B, 1075BE, 1080BE Models)*
8.917-471.0	Assembly Mounting (for 1260SS/SSG Models)*

*Required when purchasing a pressure washer and trailer package; NOT available for trailer only purchases

KITS (FIELD INSTALLED)	
PART NO.	DESCRIPTION
8.917-559.0	Rock Guard Kit
8.917-558.0	Saddle Box Kit - single box only
8.917-560.0	Utility Rack Kit (150 lb. load capacity)

HOTSY PRESSURE WASHERS / COLD WATER

BD SERIES

BELT DRIVE



BD Series shown in large cage (4-wheel) version.
Small cage 2-wheel version also available.

The **BD Series** is the most rugged cold water pressure washer on the market with its all-steel frame and cage, Hotsy belt-drive, triplex pump and cleaning power of up to 5000 PSI. Four gas models make up what is Hotsy's most durable cold water line-up ever. All models equipped with a 50' hose.



- Honda or Vanguard engine
- Small & Large Roll Cage design
- Totally enclosed belt guard
- VRT3 Uploader
- Flat free tires for easy handling
- Plated steel high-pressure wand w/ side handle
- ETL certified to UL-1776 safety standards

MODEL	PART NO.	GPM	PSI	ENGINE / MODEL	CC's	PUMP MODEL	FRAME	DIMENSIONS	NO. WHEELS	SHIP WT (lbs)
BD-373539	1.107-021.0	3.7	3500	Honda GX390	389	HM4035R.3	Small Cage	42"Lx26"Wx30"H	2	275
BD-404029	1.107-022.0	4.0	4000	Briggs VAN 16	479	HX5843R.2	Large Cage	46"Lx30"Wx36"H	4	360
BD-405039E*	1.107-023.0	4.0	5000	Honda GX630	688	HX5450R	Large Cage	46"Lx30"Wx36"H	4	417
BD-455039E*	1.107-024.0	4.5	5000	Honda GX660	688	HX5450R	Large Cage	46"Lx30"Wx36"H	4	430

*E = Electric Start

OPTIONS	
PART NO.	DESCRIPTION
8.904-109.0	E-Zee Hose Reel Kit*100' (small cage)
8.904-110.0	E-Zee Hose Reel Kit*100' (large cage)

*Kit includes hose reel and mounting hardware

OPTIONS	
PART NO.	DESCRIPTION
8.904-113.0	5000 PSI Hose Reel Kit,* (large cage)
8.904-115.0	5000 PSI Dual Hose Reel Kit,*† (large cage)

†Includes garden hose reel and high-pressure hose reel

BX SERIES

BELT DRIVE



Shown with optional hose reel & mounting kit.

The **BX Series** is the similarly rugged, but more compact, line of belt-drive cold water pressure washers. Powered by Honda engines, the BX series delivers cleaning power up to 3500 PSI and an all-steel frame protected by a durable powder coat finish. The Hotsy triplex pumps carry a 7-year limited warranty. Equipped with a 50' hose.



- Honda engines
- Totally enclosed belt guard
- Flat free tires for easy handling
- Insulated steel high-pressure wand w/ side handle
- ETL certified to UL-1776 safety standards

MODEL	PART NO.	GPM	PSI	ENGINE	CC's	START	PUMP MODEL	FRAME	DIMENSIONS	DRIVE	SHIP WT (lbs)
BX-282039	1.107-026.0	2.8	2000	Honda GX160	163	Recoil	HB3030R	Small Chassis	37"Lx21"Wx24"H	Belt	152
BX-373539	1.107-028.0	3.7	3500	Honda GX390	389	Recoil	HM4035R.2	Large Chassis	45"Lx26"Wx24"H	Belt	240

OPTIONS	
PART NO.	DESCRIPTION
8.929-062.0	Detergent Injector (up to 3 GPM)
9.802-225.0	Detergent Injector (over 3 GPM)

OPTIONS	
PART NO.	DESCRIPTION
8.723-636.0	Detergent nozzle
8.904-103.0	EZ Hose Reel Kit 100' (incl. reel & mounting hardware)*

DB SERIES

DIRECT DRIVE



The **DB Series** is the most compact, affordable alternative, in the cold water line featuring a direct-drive triplex pump. All models are powered by reliable Honda engines. Light-weight design and tubed pneumatic tires make for easy maneuvering.



- Honda GX engines
- Steel frame
- 10" tubed pneumatic tires for easy handling
- Protected by a powder coat finish
- Insulated, 2-piece steel high-pressure wand
- ETL certified to UL-1776 safety standards

DB Series shown with optional hose reel & mounting kit.

MODEL	PART NO.	GPM	PSI	ENGINE / MODEL	CC's	PUMP MODEL	DRIVE	DIMENSIONS	HOSE	SHIP WT (lbs)
DB-232439	1.107-031.0	2.3	2400	Honda GX160	163	HP2535G	Direct	35"Lx21"Wx24"H	50'	140
DB-252739	1.107-032.0	2.5	2700	Honda GX200	196	HP2535G	Direct	35"Lx21"Wx24"H	50'	145
DB-303039	1.107-033.0	3.0	3000	Honda GX270	270	HP3035G1	Direct	35"Lx21"Wx24"H	50'	175
DB-354039	1.107-222.0	3.5	4000	Honda GX390	390	HS3540G.3	Direct	35"Lx21"Wx24"H	50'	179
DB-383539	1.107-034.0	3.8	3500	Honda GX390	390	HS4040G.2	Direct	35"Lx21"Wx24"H	50'	179

OPTIONS

PART NO.	DESCRIPTION
8.904-105.0	EZ Hose Reel Kit 100' (incl. reel & mounting hardware)

HAND-HELD COLD WATER PRESSURE WASHER - GAS ENGINE

HC SERIES

Gasoline-Powered

DIRECT DRIVE



The **HC Series** is the hand-held model of the gasoline-powered line, delivering cleaning capability up to 2400 PSI. The HC is driven by a Honda engine and features a reliable direct-drive triplex pump and is ETL safety certified.



- Honda engine
- Direct-drive high-pressure pump
- Cleaning power up to 2400 PSI
- Weighs 80 lbs.
- Convenient carrying handle

MODEL	PART NO.	GPM	PSI	ENGINE / MODEL	CC's	PUMP MODEL	DRIVE	DIMENSIONS	HOSE	SHIP WT (lbs)
HC-232439	1.107-036.0	2.3	2400	Honda GX160	163	HP2535G	Direct	20"Lx16"Wx17"H	25'	95

HOT BOX

OIL FIRED

- Heater add-on
- 3000 PSI
- Diesel, kerosene, #1 heating oil
- 3/8" QC inlet / outlet



Legacy

Add hot water cleaning economically. Portable water heater add-on for existing cold water pressure washers. Quick connect to cold water washer, supply fuel and power to Hot Box for hot water cleaning applications — USE ONLY WHEN NEEDED and keep the convenience of the portable cold water washer.

- Efficient vertical combustion
- 10" easy-roll tubed pneumatic tires
- 5-gallon polyethylene fuel tank
- 36' Ground Fault Interrupter plug
- Thermostat temperature control
- Compact size — 37" W x 27" L x 39" H

MODEL	PART NO.	DESCRIPTION
HOT BOX	1.103-910.0	5 GPM/3000 PSI - 120V

HOTSY PRESSURE WASHERS / COLD WATER

HD SERIES



The **HD Series** are our modular cold water pressure washers with corrosion resistant aluminum frame. Wheels can be removed allowing for easy trailer mounting. Models are available in belt or direct drive and powered by Honda GX engines. The HD series features a durable VTR3 unloader with bypass loop, commercial duty pump and a 50' hose.



DIRECT DRIVE
BELT DRIVE

- Honda GX engines
- Modular design convert to skid
- VTR3 Unloader with bypass loop
- Flat free tires for easy handling
- Downstream chemical injection
- ETL certified to UL-1776 safety standards

MODEL	PART NO.	GPM	PSI	ENGINE / MODEL	CC's	START	PUMP MODEL	DRIVE	DIMENSIONS	HOSE	SHIP WT (lbs)
HD 3.0/27 G	9.807-711.0	3.0	2700	Honda GX200	196	Recoil	LP3035	Direct	41"Lx22"Wx24"H	50'	112
HD 3.5/35 G	9.807-712.0	3.5	3500	Honda GX270	270	Recoil	LP3535G.1	Direct	41"Lx22"Wx24"H	50'	130
HD 4.0/40 G	9.807-713.0	4.0	4000	Honda GX390	389	Recoil	LS4040G.3	Direct	43"Lx26"Wx27"H	50'	149
HD 4.0/40 Ge	9.807-714.0	4.0	4000	Honda GX390	389	Electric	LS4040G.3	Direct	43"Lx26"Wx27"H	50'	158
HD 3.0/27 GB	9.807-715.0	3.0	2700	Honda GX200	196	Recoil	LP3035G	Belt	41"Lx22"Wx24"H	50'	123
HD 3.5/35 GB	9.807-716.0	3.5	3500	Honda GX270	270	Recoil	LM3540R.3	Belt	41"Lx22"Wx24"H	50'	156
HD 4.0/40 GB	9.807-717.0	4.0	4000	Honda GX390	389	Recoil	LM3840R.3	Belt	43"Lx26"Wx27"H	50'	160
HD 4.0/40 GeB	9.807-718.0	4.0	4000	Honda GX390	389	Electric	LM3840R.3	Belt	43"Lx26"Wx27"H	50'	196

OPTIONS	
PART NO.	DESCRIPTION
9.807-750.0	37.5" Handle
9.807-751.0	Handle with Hose Reel
9.807-752.0	Hose Hook

OPTIONS	
PART NO.	DESCRIPTION
9.807-753.0	Wand Holder
9.807-754.0	Skid Mount Feet (set of 4)

SKID OPTIONS

Dealer Assembly Required. Pressure washer sold separately.

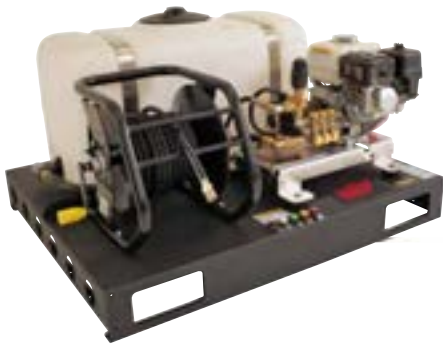

The perfect accompaniment to Hotsy HD Series pressure washers – these mild steel skids offer two configurations: skid with a 50 gallon water tank and 100' hose reel OR skid with two 100' hose reels. The HD Skids fit within a standard UTV / ATV bed when ordering the direct drive models as depicted below. NOTE: Belt drive models extend beyond the frame and are not recommended. Skid feet included.

DESCRIPTION	PART NO.	FRAME MATERIAL	WATER TANK	HOSE REEL	COMPATABLE PRESSURE WASHER (SOLD SEPERATELY)	DIMENSIONS (L x W x H) INCHES	SHIP WT (lbs)
One 100' Hose Reel & 50 Gal WaterTank	9.807-835.0	Mild Steel	50 gallon	1	HD 3.0/27 G 9.807-711.0 HD 3.5/35 G 9.807-712.0 HD 4.0/40 G 9.807-713.0	40"L x 48"W x 35"H	180 (excluding the pressure washer)
Two 100 Ft. Hose Reels	9.807-840.0	Mild Steel	Not Included	2	HD 3.0/27 G 9.807-711.0 HD 3.5/35 G 9.807-712.0 HD 4.0/40 G 9.807-713.0	40"L x 48"W x 35"H	172 (excluding the pressure washer)

HOTSY PRESSURE WASHERS / COLD WATER

1700 SERIES

BELT DRIVE



The **1700 Series** offers the most reliable stationary, electric-powered, cold water pressure washer featuring a Hotsy belt-drive, triplex pump with 7-year limited warranty, insulated variable pressure wand and ETL safety certification. All models equipped with a 50' hose.

- Baldor electric motor, 2-10 HP
- Downstream detergent injector
- Insulated SS variable pressure wand
- Hot Water Seal Kit standard
- Option-ready for Time Delay Shutdown or Auto Start/Stop

Shown with optional stainless steel cabinet

MODEL	PART NO.	GPM	PSI	HP	VOLT/PH	AMPS	PUMP MODEL	DRIVE	PORTABILITY	DIMENSIONS	SHIP WT (lbs)
1710	1.106-511.0	2.8	1000	2	120/1	20	HB3030R	Belt	Optional	31"Lx21"Wx16"H	200
1720	1.106-512.0	3.9	2000	6	230/1	28	HM4030R.3	Belt	Optional	31"Lx21"Wx16"H	275
1722	1.106-513.0	3.9	2000	6	208/1	30	HM4030R.3	Belt	Optional	31"Lx21"Wx16"H	240
1723	1.106-514.0	3.9	2000	6	208/3	16	HM4030R.3	Belt	Optional	31"Lx21"Wx16"H	250
1724	1.106-515.0	3.9	2000	6	230/3	14	HM4030R.3	Belt	Optional	31"Lx21"Wx16"H	250
1725	1.106-516.0	3.9	2000	6	460/3	7	HM4030R.3	Belt	Optional	31"Lx21"Wx16"H	250
1726	1.106-590.0	3.9	2000	7.5	575/3	TBD	HM4030R.3	Belt	Optional	31"Lx21"Wx16"H	TBD
1743	1.106-529.0	4.8	3000	10	208/3	31	HM4035R.3	Belt	Optional	31"Lx21"Wx16"H	302
1744	1.106-530.0	4.8	3000	10	230/3	27	HM4035R.3	Belt	Optional	31"Lx21"Wx16"H	300
1745	1.106-531.0	4.8	3000	10	460/3	14	HM4035R.3	Belt	Optional	31"Lx21"Wx16"H	315
1746	1.106-591.0	4.8	3000	10	575/3	TBD	HM4035R.3	Belt	Optional	31"Lx21"Wx16"H	TBD
1753	1.106-534.0	5.6	2500	10	208/3	31	HX9536R.2	Belt	Optional	31"Lx21"Wx16"H	320
1754	1.106-535.0	5.6	2500	10	230/3	27	HX9536R.2	Belt	Optional	31"Lx21"Wx16"H	310
1755	1.106-536.0	5.6	2500	10	460/3	14	HX9536R.2	Belt	Optional	31"Lx21"Wx16"H	310
1756	1.106-592.0	5.6	2500	10	575/3	TBD	HX9536R.2	Belt	Optional	31"Lx21"Wx16"H	TBD

OPTIONS	1700 SERIES
PART NO.	DESCRIPTION
9.801-031.0	Kit, 1700 Wheel w/Chemical Rack (black)
9.804-527.0	Kit, 1700 Wheel w/Chemical Rack (stainless steel)
9.801-033.0	Kit, 1700 Wall Mount
9.801-034.0	Kit, 1700 Floor Stand, Tall (20 3/4"W x 29"D x 36"H)
9.801-035.0	Kit, Caster Wheels for 1700 Floor Stand
9.803-039.0	Kit, Hose Reel w/Bracket for 1700 Stand & Wall Mount Kits
9.803-040.0	Kit, 1700 Floor Stand, Short (20 3/4"W x 29"D x 24"H)
9.803-043.0	Kit, 1700 Wall Mount, Stainless Steel
9.803-041.0	Time Delay Shut Down, For 172x, 173x & 174x Models (Factory Installed)
9.803-045.0	Time Delay Shut Down for 1710 (Factory Installed)*
9.803-044.0	Time Delay Shut Down for 175x Models (Factory Installed)
9.803-042.0	Stainless Steel Base & Cover for 172x, 174x, 175x Models (Factory Installed)
9.823-421.0	Stainless Steel Base & Cover for 1710 Only (Factory Installed)
9.803-047.0	Automatic Stop/Start for 1710 & 172x Models (Factory Installed)

OPTIONS	1700 SERIES
PART NO.	DESCRIPTION
8.903-048.0	Automatic Stop/Start for 175x Models (Factory Installed)
8.903-046.0	Automatic Stop/Start for 173x & 174x Models (Factory Installed)
8.903-617.0	Kit, 1700 Floor Stand, Tall, Stainless Steel
8.903-521.0	Kit, Hose Reel for Wheel Kit 100 ft. (excludes hose)



1700 Series shown with optional hose reel kit, (PN 8.903-039.0), Tall Floor Stand (PN 9.801-034.0), caster wheel kit (PN 9.801-035.0) and stainless steel base and cover (PN 8.903-042.0).

Model 1710 shown with optional wheel kit and chemical rack (PN 9.801-031.0). Note - this is not the short stand.



* Note: Time Delay Shutdown and Auto Start/Stop cannot be combined on the same machine

CWC SERIES

BELT DRIVE



- Smart Relay Control provides control over run time, auto start/stop and shut down functionality

The **CWC Series** is a completely self-contained stationary, electric-powered, cold water washer with programmable smart control, upstream detergent injector and ETL safety certification. Remote ready for wash bays. All models equipped with a 50' hose. Ideal for the food industry since hot water can be used.

OPTIONS	DESCRIPTION
PART NO.	DESCRIPTION
8.924-814.0	R-Con Wireless Remote Kit (1 remotes/1 receiver)
8.925-072.0	R-Con Wireless Remote Kit (2 remotes/1 receiver)
8.924-878.0	Wall Mount Remote Bracket for R-Con
8.756-329.0	Replacement Remote (transmitter only)

MODEL	PART NO.	GPM	PSI	HP	MOTOR RPM	VOLT/PH	AMP	PUMP MODEL	HOSE	SHIP WT (lbs)
CWC-53	1.106-572.0	4.0	3000	7.5	1725	230/1	36	HM4030R.3	50'	340
CWC-54	1.106-573.0	4.0	3000	7.5	1725	230/3	23	HM4030R.3	50'	340
CWC-55	1.106-574.0	4.0	3000	7.5	1725	460/3	11	HM4030R.3	50'	340
CWC-56	1.106-575.0	4.0	3000	7.5	1770	575/3	9	HM4030R.3	50'	340
CWC-63	1.106-576.0	5.0	2000	7.5	1725	230/1	28	HM4035R.3	50'	340
CWC-64	1.106-577.0	5.0	2000	7.5	1725	230/3	18	HM4035R.3	50'	340
CWC-65	1.106-578.0	5.0	2000	7.5	1725	460/3	9	HM4035R.3	50'	340
CWC-66	1.106-579.0	5.0	2000	7.5	1770	575/3	8	HM4035R.3	50'	340

HOTSY PRESSURE WASHERS / COLD WATER

HD SERIES

Electric-Cart



The **HD Series** electric carts are corrosion-resistant aluminum cold water pressure washers that easily convert from a cart to a skid for maximum cleaning versatility. Low profile handle and compact footprint. Includes bypass loop for additional pump protection.



- Aluminum frame
- Converts easily to skid style frame
- Flat free tires for easy handling
- Downstream chemical injection
- ETL safety certification

DIRECT DRIVE

MODEL	PART NO.	GPM	PSI	HP	VOLT/PH	MOTOR RPM	AMPS	PUMP MODEL	DIMENSIONS	HOSE	SHIP WT (lbs)
HD 1.9/13 Ed	9.801-798.0	1.9	1300	2	120/1	1725	20	LF2030S	35"Lx21"Wx24"H	50'	196
HD 2.0/10 Ed	9.801-797.0	2.0	1000	1.5	120/1	1725	15	LF2030S	35"Lx21"Wx24"H	50'	212
HD 3.0/10 Ea	9.801-799.0	3.0	1000	2	120/1	1725	20	LF2830S	35"Lx21"Wx24"H	50'	219
HD 3.5/20 Ea	9.801-800.0	3.5	2000	5	230/1	3450	22	LF3530F	35"Lx21"Wx24"H	50'	220

OPTIONS HD SERIES

PART NO.	DESCRIPTION
9.807-754.0	Skid Feet
9.807-750.0	37.5" Long Handle

OPTIONS HD SERIES

PART NO.	DESCRIPTION
9.807-752.0	Hose Storage Hook
9.807-753.0	Wand Holder

BDE SERIES

BELT DRIVE



The **BDE Series** is the electric equivalent of the BD Series. Hotsy belt-drive, triplex pump and cleaning power of 5000 PSI. Both models feature the large cage frame and are equipped with a 50' hose.



- 1765 RPM Motor
- Totally enclosed belt guard
- 12' cord length
- NEMA 4-Electrical Box
- Flat-free tires for easy handling
- Plated steel high-pressure wand w/ side handle
- ETL certified to UL-1776 safety standards

MODEL	PART NO.	GPM	PSI	HP	MOTOR RPM	VOLT/PH	AMPS	PUMP MODEL	PUMP RPM	HOSE	DIMENSIONS	SHIP WT (lbs)
BDE-505009B	1.107-085.0	5.0	5000	20	1765	230/3	48	HX5450R	1650	50'	46"Lx30"Wx36"H	524
BDE-505009C	1.107-086.0	5.0	5000	20	1765	460/3	26	HX5450R	1650	50'	46"Lx30"Wx36"H	524

OPTIONS

PART NO.	DESCRIPTION
8.904-110.0	E-Zee Hose Reel Kit*100' (large cage)

OPTIONS

PART NO.	DESCRIPTION
8.904-113.0	5000 PSI Hose Reel Kit* (large cage)
8.904-115.0	5000 PSI Dual Hose Reel Kit,*† (large cage)

*Kit includes hose reel and mounting hardware †Includes garden hose reel and high-pressure hose reel

HAND-HELD COLD WATER PRESSURE WASHER - ELECTRIC

ET SERIES

Electric-Powered



The **ET Series** is the hand-held model of the electric-powered line, delivering cleaning capability up to 1400 PSI. The ET features a reliable direct-drive triplex pump and is ETL safety certified.



- 1725 RPM Motor
- Direct-drive high-pressure pump
- 25' & 50' hose
- Convenient carrying handle
- Remote switch with 10' cord (ET-201409DX2 only)
- Accepts incoming hot water up to 180°F
- Standard auto start/stop (ET-201409DX2 only)

Note: Detergent Injector Sold Separately

MODEL	PART NO.	GPM	PSI	HP	VOLT/PH	PUMP MODEL	DRIVE	DIMENSIONS	HOSE	SHIP WT (lbs)
ET-301109D	1.106-107.0	3.0	1000	2.0	115/1	HF2830S	Direct	20"Lx19"Wx17"H	50'	121
ET-201409DX2	1.107-089.0	1.8	1400	2.0	115/1	HF2030S	Direct	20"Lx19"Wx17"H	25'	123

OPTIONS ET SERIES

PART NO.	DESCRIPTION
8.920-952.0	Wall Mount Bracket

OPTIONS ET SERIES

PART NO.	DESCRIPTION
8.929-062.0	Detergent Injector (up to 3 GPM)

HEAT MIZER

HEAT SERIES

- Radiant Portable Heaters
- Uses Kerosene, Diesel #1, Diesel #2 or Jet Fuel



Note: Heaters have limited seasonal availability

The **HeatMizer Heaters** are portable, radiant heaters offering clean combustion with 99.9% efficiency. Using direct heat flow by radiation, there's very little air movement. Ideal for warming areas where workers are cleaning, constructions sites, animal pens and curing concrete. Features a metallic forced air insulation pocket between the combustion chamber and the external protection cone, which keeps the cone cool to the touch.

- Patented triple cone design
- Low noise level
- Extendable sliding floor shield
- Automatic post-ventilation cooling cycle
- Air pressure switch safety device
- CSA Approved



MODEL	PART NO.	BTU/HR	VOLT/PH	AMP RATING	TANK CAPACITY (GAL)	RUN TIME (HR)	DIMENSIONS	DRY WT (lbs)
HEATMIZER 115	1.103-078.0	115,000	120V/1	2.15	11.35	13.4	30"Lx23"Wx28"H	92
HEATMIZER 155	1.103-079.0	155,000	120V/1	4.1	17.2	16	41"Lx28"Wx43"H	161

OPTIONS

PART NO.	DESCRIPTION
8.755-314.0	Thermostat 20-120°F w/30' Cable w/90° Plug
8.755-315.0	Preheated Fuel Filter (for model 155)
8.755-335.0	Fuel Level Gauge

REDHOT CANNON

HEAT SERIES

- Indirect-Fired
- Uses Kerosene, Diesel #1, Diesel #2 or Jet Fuel
- Can be used indoors and ducted



The **RedHot Cannon Heaters** are diesel indirect-fired portable heaters use an embedded burner with combustion air obtained from the main ventilation fan. Models feature a heat exchanger which contains the flame and expels fumes through a chimney which can be connected to the outside. Four pass heat exchange technology allows exhaust gases to increase heat exchange with the cooling air, and obtain maximum thermal efficiency.

- Air pressure switch safety device
- Auto post ventilation cooling cycle
- 6-inch flue size
- CSA Approved



MODEL	PART NO.	BTU/HR	TEMPERATURE RISE (@64°F)	VOLT/PH	AMP RATING	TANK CAPACITY (GAL)	RUN TIME (HR)	DIMENSIONS	DRY WT (lbs)
REDHOT CANNON 100	1.103-075.0	94,759	95	120V/1	4.05	11	14	46"Lx20"Wx28"H	143
REDHOT CANNON 200	1.103-076.0	183,362	136	120V/1	7.65	17.2	14	52"Lx20"Wx38"H	238
REDHOT CANNON 300	1.103-077.0	258,704	126	120V/1	11.80	27.7	13	67"Lx25"Wx42"H	330

OPTIONS

PART NO.	DESCRIPTION
8.755-316.0	Fuel Level Gauge (for HeatCannon 100)
8.755-317.0	Fuel Level Gauge (for HeatCannon 200/300)
8.755-318.0	Fuel Tank Filter
8.755-319.0	4 Lifting Brackets
8.755-320.0	Single Fuel Line Kit
8.755-321.0	12" 1-Way Duct Adapter (for model 100)
8.755-322.0	14" 1-Way Duct Adapter (for model 200)
8.755-323.0	16" 1-Way Duct Adapter (for model 300)

OPTIONS

PART NO.	DESCRIPTION
8.755-324.0	12" 2-Way Duct Adapter (for model 200)
8.755-325.0	12" 2-Way Duct Adapter (for model 300)
8.755-314.0	Thermostat 20-120°F w/30' Cable w/90° Plug
8.755-327.0	External Fuel Tank Connection Kit
8.755-328.0	External Fuel Tank Connection Kit w/Deaerator (Tiger Loop)
8.755-329.0	Preheated Fuel Filter (for model 100)
8.755-330.0	12" x 20' Flexible Air Duct
8.755-331.0	14" x 20' Flexible Air Duct
8.755-332.0	16" x 20' Flexible Air Duct

HOTSY BRANDED PARTS

HOTSY Guns



Designed exclusively for Hotsy to meet the demands of the high pressure cleaning professional.



- **PSI:** 5000
- **GPM:** 10.5
- **Temperature:** 320°F
- 3/8" FPT inlet x 1/4" FPT outlet
- Weight: 20 oz

Part No.	Description
8.751-235.0	Hotsy Gun
8.751-119.0	Hotsy Gun Repair Kit



- **PSI:** 3750
- **GPM:** 12
- **Temperature:** 300°F
- 3/8" FPT inlet x 1/4" FPT outlet
- Weight: 24 oz



Part No.	Original No.	Description
8.711-345.0	860447	Hotsy Gun
8.717-658.0	877471	Hotsy Gun Repair Kit



- **PSI:** 4500
- **GPM:** 10
- **Temperature:** 300°F
- 3/8" FPT inlet x 1/4" FPT outlet
- Weight: 26 oz



Part No.	Original No.	Description
8.711-346.0	691867	Hotsy Gun
8.717-660.0	753179	Hotsy Gun Repair Kit

HOTSY Lance Grip



- Easily fastened to any 1/4" wand
- 12" in length
- Zytel material for long life

Part No.	Original No.	Description
8.717-661.0	859762	12" Insulated Grip

HOTSY Side Handle



Side handle easily adjusts to provide a safe, ergonomic addition to any straight Lance.

- Easily attaches to metal lances
- Fits 1/4" lances

Part No.	Original No.	Description
8.706-670.0	859763	Wand Side Handle

HOTSY Dual Lance



The Hotsy dual lance simply out classes the competition. 35" and 48" length to meet UL Standards. Designed specifically for Hotsy to our specifications.



- **PSI:** 3000
- **Temperature:** 220°F
- For use with downstream injection
- Detergent control side handle

Part No.	Original No.	Description
8.711-314.0	878912	35" Cold Water
8.711-315.0	878913	35" Hot Water w/Grip
8.711-313.0	878911	48" Hot Water w/Grip
8.717-662.0	877600	Repair Kit
8.711-316.0	878918	Brass Body
8.717-268.0	861420	Handle, Valve

HOTSY Hot Water Lance



Hotsy quality through and through. Superior heat protection with zytel insulated grips.



- **PSI:** 4000
- **Temperature:** 220°F
- 1/4" plated steel pipe
- 1/4" threads
- Zytel insulated grips

Part No.	Original No.	Description
8.711-274.0	936610	15" Lance w/Grip
8.752-893.0		28" Lance w/Grip
8.904-324.0		36" Lance w/ Nozzle Protector
8.725-389.0		36" Lance w/Grip & Side Handle
8.725-388.0		48" Lance w/Grip & Side Handle
8.752-896.0		60" Lance w/Grip
8.752-897.0		79" Lance w/Grip

HOTSY Cold Water Lances



- **PSI:** 3000
- 1/4" plated steel pipe
- 1/4" threads

Part No.	Original No.	Description
9.802-214.0	936701	36" Lance w/ Side Handle
8.711-272.0	768391	48" No Side Handle, 4000 PSI

Hotsy High-Pressure Hose

For use with hot or cold-water pressure washers

Introducing the new Hotsy R1 and R2 high-pressure hose. The R1 and R2 hose is built to exceed the EN1829-2 Standard and will provide superior abrasion resistance that will increase the life of the hose. The R1 and R2 hose is rated up to 250°F and is available in 4000, 5000 and 6000 PSI.

Both single- and double-wire braid hoses come with durable bend restrictors on both ends, with a 24-inch bend restrictor on the gun end for added operator protection against high-pressure bursts.

The R1 and R2 hose has a “bite-the-wire” coupling that grips the hose better than any other design.

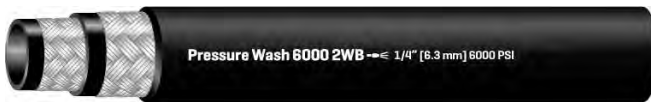

- **Temperature Rating:** R1 and R2 hoses are rated for continuous temperatures up to 250°F.
- **Easily Identified:** Permanently embossed identification makes for easy tracing and owner protection.
- **Certified Burst Protection:** R1 and R2 hose meets the stringent UL-1776 safety standards with two hose guards—including a 24-inch sleeve on the gun end—for added operator protection against bursts.
- **Unique Coupling:** A “bite-the-wire” coupling actually reaches the wire braid for never-slip retention, far superior to the “compression” fittings used on conventional hoses.

Hotsy R1 1-Wire 4000 PSI Hose



- Hotsy branded bend black restrictor
- Smooth impression oil resistant tube and cover with black hose guard, both ends
- Rated to 250°F

Part No.	Size	ID	Temp	Fittings	PSI
3/8" MPT Swivel x 3/8 MPT Swivel					
8.925-151.0	25'	3/8	250°F	SWxSW	4000
8.925-157.0	50'	3/8	250°F	SWxSW	4000
8.925-162.0	75'	3/8	250°F	SWxSW	4000
8.926-166.0	100'	3/8	250°F	SWxSW	4000
8.925-171.0	150'	3/8	250°F	SWxSW	4000
8.925-353.0	200'	3/8	250°F	SWxSW	4000
8.925-379.0	(75) 50'	3/8	250°F	SWxSW	4000
8.926-443.0	(40) 100'	2/8	250°F	SWxSW	4000

Part No.	Size	ID	Temp	Fittings	PSI
3/8" MPT Swivel x 3/8 MPT Solid					
8.926-174.0	50'	3/8	250°F	SWxSO	4000
8.926-373.0	100'	3/8	250°F	SWxSO	4000
8.926-352.0	200'	3/8	250°F	SWxSO	4000

Hotsy R2 1-Wire 5000 PSI Hose

Part No.	Size	ID	Temp	Fittings	PSI
1/2" MPT Swivel x 3/8 MPT Solid					
8.925-242.0	50'	1/2	250°F	SWxSO	5000
8.925-248.0	75'	1/2	250°F	SWxSO	5000
8.925-250.0	100'	1/2	250°F	SWxSO	5000

Hotsy R2 2-Wire 6000 PSI Hose



- Hotsy branded bend black restrictor
- Smooth impression oil resistant tube and cover with black hose guard, both ends
- Rated to 250°F

Part No.	Size	ID	Temp	Fittings	PSI
3/8" MPT Swivel x 3/8 MPT Swivel					
8.925-181.0	25'	3/8	250°F	SWxSW	6000
8.925-185.0	50'	3/8	250°F	SWxSW	6000
8.925-226.0	75'	3/8	250°F	SWxSW	6000
8.925-230.0	100'	3/8	250°F	SWxSW	6000
8.925-233.0	150'	3/8	250°F	SWxSW	6000
8.925-372.0	200'	3/8	250°F	SWxSW	6000
8.925-383.0	(75) 50'	3/8	250°F	SWxSW	6000
8.925-444.0	(40) 100'	3/8	250°F	SWxSW	6000

Part No.	Size	ID	Temp	Fittings	PSI
3/8" MPT Swivel x 3/8 MPT Solid					
8.925-374.0	50'	3/8	250°F	SWxSO	6000
8.925-375.0	100'	3/8	250°F	SWxSO	6000
8.925-371.0	200'	3/8	250°F	SWxSO	6000

HOTSY BRANDED PARTS

Tuff-Flex 1-Wire 3000 PSI Blue Non-Mar Hose



- Hotsy branded black bend restrictor
- Smooth, maximum oil resistant tube blue non-marking cover.
- 20% greater flexibility
- 7 times greater abrasion resistance
- 3/8" MPT Swivel x 3/8" MPT Swivel

Part No.	Size	ID	Temp	PSI	Color
8.739-121.0	50'	3/8	250°F	3000	Blue
8.739-123.0	100'	3/8	250°F	3000	Blue

Tuff-Flex 2-Wire 4500 PSI Blue Non-Mar Hose



- Hotsy branded red bend restrictor
- Smooth, maximum oil resistant tube blue non-marking cover.
- 20% greater flexibility
- 7 times greater abrasion resistance
- Built to SAE 100R1AT OD dimensions
- 3/8" MPT Swivel x 3/8" MPT Swivel

Part No.	Size	ID	Temp	PSI	Color
8.739-198.0	50'	3/8	250°F	4500	Blue
8.739-200.0	100'	3/8	250°F	4500	Blue

HOTSY Fuel Filter/ Water Separator



- Extends life of fuel system
- Clear sediment bowl and washable screen
- Drain valve
- Filters gasoline and diesel fuel

Part No.	Original No.	Description
8.717-710.0	851084	Filter, Fuel/ Oil Water Separator
8.717-711.0	875490	Replacement Screen

Fuel Filter/Water Separator



- 10 micron filtration
- Spin-on convenience
- Water separation chamber
- 1/4" FPT inlet/outlet
- Easy drain water/sediment bowl

Part No.	Description
8.749-771.0	Complete Unit
8.749-770.0	Element

Touch-Up Paint



- Matches the color on your Hotsy
- Comes in aerosol or dab/brush

Part No.	Original No.	Description
8.720-519.0	910215	12 oz Aerosol - Red
8.723-214.0	503.088	12 oz Aerosol - APW Gray

NOTE: Aerosol containers cannot ship UPS Air

Hotsy Hose Reels

Fully assembled and ready to use!

Hotsy hose reels were designed for ease of use and durability in commercial pressure washer applications.

Offering 100' and 200' reels in both a fixed base and 360 degree rotating base. The oversized reel holds the advertised length plus leaves additional space reducing the difficulty of reeling hose. The unique extended swivel improves the hose connection and reduces hose wear and stress.

Features:

- Rugged heavy-duty construction for commercial applications.
 - Heavy gauge steel fabrication with durable handle
 - Gloss black powder coating
 - Easy to use brake mechanism reduces unwinding backlash
 - Oversized heavy-duty locking mechanism prevents slippage during reel operation.
- "Flip-Over" hose guide: Allows ease of use from either side of the reel
- Oversized: Oversized to easily fit the advertised length of hose. When we say 100' we mean 100+ feet will easily fit.
- Swivel design: The reels come with an extended swivel which prevents bends and stress on the hose where it attaches to the reel.
- Rotary mount: 360 degree rotation with an oversized heavy-duty locking mechanism. Allows for continual alignment with the hose.
 - Mount to round or square tubing
- Fully assembled: Ready to use out of the box. Saves time and money.
- 2-year warranty on the swivel

Specifications:

- 5000 PSI
- 325°F
- 100' and 200' fixed base
- 100' and 200' 360 degree rotating base
- High pressure double seal swivels.



Fixed Base
Hose Reel



360° Pivot
Reel

Part No.	Description	Length
8.750-486.0	Pivot Reel	100' x 3/8"
8.750-483.0	Pivot Reel	200' x 3/8"
8.750-478.0	Fixed Based	100' x 3/8"
8.750-481.0	Fixed Based	200' x 3/8"

NOTE: Hose not included

Part No.	Description
8.919-430.0	Universal Mount*
8.919-794.0	Skid Mount*
8.919-437.0	Wall Mount*
8.919-434.0	Base Mount*
8.919-072.0	Bracket, Universal*
8.919-445.0	Bracket, 90°*
8.919-441.0	Bracket, 45°*
8.919-448.0	Bracket, Vertical*

Bracket Sockets



Universal Mount Skid Mount Wall Mount Base Mount

Non-Pivot Reel Brackets



Universal 90° 45° Vertical

Fixed Base Hose Reels & Mounting Bracket Options

Hot Water Electric Models	Connector Hose*	Bracket #1 45° Arm	Bracket #2 90° Arm	Bracket #3 Vertical Arm
555SS	8.901-464.0 (4 ft)	8.919-441.0	8.919-445.0	8.919-448.0
560SS	8.901-472.0 (6 ft)	8.919-441.0	8.919-445.0	8.919-448.0
680SS	8.901-464.0 (4 ft)	8.919-441.0	8.919-445.0	8.919-448.0
790SS	8.901-464.0 (4 ft)	8.919-441.0	8.919-445.0	8.919-448.0
795SS	8.901-464.0 (4 ft)	8.919-441.0	8.919-445.0	8.919-448.0
795SS-208	8.901-464.0 (4 ft)	8.919-441.0	8.919-445.0	8.919-448.0
895SS	8.901-464.0 (4 ft)	8.919-441.0	8.919-445.0	8.919-448.0
800 Series	8.901-472.0 (6 ft)	8.919-441.0	8.919-445.0	8.919-448.0

Hotsy 360° Pivot Hose Reels & Connector Hose Options

NOTE: Models come standard with pivot reel receptacle - no additional bracket is required.

Hot Water Electric Models	Connector Hose*
555SS	8.901-460.0 (3 ft)
560SS	8.901-464.0 (4 ft)
680SS	8.901-464.0 (4 ft)
790SS	8.901-464.0 (4 ft)
795SS	8.901-464.0 (4 ft)
795SS-208	8.901-464.0 (4 ft)
895SS	8.901-464.0 (4 ft)
800 Series	8.901-472.0 (6 ft)

Pressure washer hose not included

*Required to connect hose reel to pressure washer.

Hotsy Stackable Hose Reels & Accessories



Patent-pending hose reels built specifically for contractors who require flexibility on a job site. Stackable reels are supported on both sides of the central hub to accommodate more aggressive applications, such as trailer-mounted.

*Patent D739,715S and other Patents Pending



200' Mild Steel Ready-Stack Hose Reel

100' Mild Steel Ready-Stack Hose Reel

Stainless Steel Ready-Stack Hose Reel

- Reel and swivel rated up to 6000 PSI and 350°F
- Integrated frame adds protection and stacking ability
- Accommodates hose lengths of up to 100' or 200'
- Ideal for stacking on a trailer
- Heavy-duty powder-coated steel or stainless steel
- Modular design allows user to configure to meet various needs
- Reversible hand-crank and swivel



Hose Reel Riser feeds hose over and around obstacles

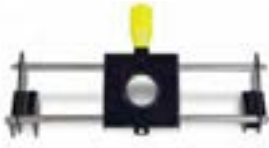

Hose Guide directs hose back onto reel for a more uniform fit



Reel Cart System helps to easily move multiple hoses and reels where needed

Part No.	Description
9.801-775.0	100' Mild Steel Hose Reel
9.801-776.0	200' Mild Steel Hose Reel
9.801-777.0	100' Stainless Steel Hose Reel
9.801-778.0	200' Stainless Steel Hose Reel
8.923-415.0	100' Hose Guide
8.923-427.0	200' Hose Guide
8.923-918.0	Wheel Cart
8.923-416.0	Riser



Configured 200' Mild Steel Stackable Hose Reel with Optional Hose Guide and Hose Reel Riser



Configured 200' Mild Steel Stackable Hose Reels with Optional Reel Cart System and Hose Guide

HOTSY Nozzles



1/4" Nozzle

1/4" male pipe thread nozzles, rated up to 5100 PSI. Hardened stainless steel nozzle insures consistent, accurate orifice size.

Nozzle Size	0° Part No.	Orig. No.	0° Part No.	15° Orig. No.	40° Part No.	40° Orig. No.
4.0	8.711-375.0	900850	8.711-377.0	900851	8.711-380.0	900852
4.5	8.711-383.0	900854	8.711-385.0	900847	8.711-388.0	900848
5.0	8.711-389.0	900842	8.711-392.0	900843	8.711-395.0	900844
5.5	8.711-396.0	900858	8.711-398.0	900859	8.711-402.0	900860
6.0	8.711-404.0	900861	8.711-406.0	900862	8.711-411.0	900864
6.5	-	-	8.711-412.0	900800	8.711-414.0	900801
7.0	8.711-416.0	900894	8.711-417.0	900895	8.711-419.0	900896
7.5	8.711-422.0	900898	8.711-423.0	900899	-	-
8.0	8.707-723.0	727742	8.711-424.0	900903	8.711-426.0	900905
8.5	8.711-427.0	900917	8.711-429.0	900918	8.711-432.0	900920
9.0	8.711-434.0	900929	8.711-435.0	900930	8.711-438.0	900932
12	-	-	8.707-766.0	727786	8.707-768.0	251435
15	8.711-447.0	900376	8.711-448.0	900377	8.707-790.0	799206
20	8.707-795.0	727752	8.711-452.0	900422	8.707-804.0	900973
40	-	-	8.707-824.0	900991	-	-

HOTSY Adjustable Fan Nozzle



- 3000 PSI
- 300°F
- 1/4" inlet

3000 maximum PSI, Vari-fan nozzle easily adjusts from 0° to 80° fan size with a simple twist of the nozzle head.

Part No.	Orig No.	Orifice
8.712-400.0	799100	3.5
8.712-401.0	799101	4.0
8.712-407.0	799102	4.5
8.712-402.0	799103	5.0
8.712-408.0	799104	5.5

Part No.	Orig No.	Orifice
8.712-406.0	799119	6.0
8.712-569.0	799105	6.5
8.712-410.0	799106	7.5
8.717-690.0	753112	Repair Kit

HOTSY High / Low Adjustable Fan Nozzle



- 3000 PSI
- 200°F
- Low pressure soap injection
- 1/4" inlet

All the features of the variable fan nozzle. Plus with a pull, nozzle lowers pressure for chemical application.

Part No.	Orig No.	Orifice
8.717-576.0	799169	3.0
8.717-570.0	799107	3.5
8.717-571.0	799108	4.0
8.712-404.0	799109	4.5
8.717-572.0	799110	5.0
8.712-403.0	799111	5.5

Part No.	Orig No.	Orifice
8.717-575.0	799124	6.0
8.717-573.0	799112	6.5
8.717-574.0	799113	7.5
8.717-691.0	753113	Repair Kit

Hotsy Nozzle Protector



- Fits 1/4" lances
- Protects nozzles from damage

Part No.	Original No.	Description
8.717-320.0	918392	1/4" Nozzle Protector

HOTSY Twist Quick Couplers



- Precision brass design
- Unrestricted free flow
- 4000 PSI max

Swivels, designed for 4000 PSI and extended durability. Affordable and rugged all in one.

Part No.	Original No.	Description
8.717-562.0	826301	1/4" FNPT
8.707-189.0	826300	3/8" FNPT
8.717-568.0	826304	1/2" FNPT

Part No.	Original No.	Description
8.717-561.0	826303	1/4" MNPT
8.717-560.0	826302	3/8" MNPT
8.717-567.0	826305	1/2" MNPT



- Zinc plated
- Hardened steel
- 4000 PSI max

Zinc Plated Nipples, hardened steel combined with zinc yellow chromate plating holds up to the harshest environments.

Part No.	Original No.	Description
8.717-564.0	826291	1/4" FNPT
8.707-187.0	826290	3/8" FNPT
8.717-566.0	826294	1/2" FNPT

Part No.	Original No.	Description
8.717-563.0	826293	1/4" MNPT
8.707-188.0	826292	3/8" MNPT
8.717-565.0	826295	1/2" MNPT

Replacement O-rings, for HOTSY twist coupler, Buna-n.

Part No.	Original No.	Description
8.717-230.0	926660	Replacement O-ring

Two-Gun Tee Coupler



Two-Gun Tee Coupler makes switching from one gun to two a snap. 3/8" quick coupler fittings good up to 4000 PSI.



- For use with dual gun systems
- Couples onto outlet nipple
- 3/8" couplers

Adjustable Nozzle



Compact full feature unit weighs only 4.3 oz., same functions as ST-51N.



- 3600 PSI
- 10 GPM
- 300°F
- Machined brass body
- Nylon adjustment knob
- 1/4 FPT inlet/outlet

Part No.	Original No.	Description
9.802-950.0	900260	Adjustable Nozzle

Color-Coded 1/4" QC Nozzle Kits *Legacy*

Available in kits or individually.



- Hardened SS one piece body for long life
- High impact, uniform, flat spray pattern
- Color-coded by spray angle
- Rated up to 4000 PSI
- 4-pack includes 0°, 25°, 40°, soap nozzles
- 5-pack includes 0°, 15°, 25°, 40°, soap nozzles

ST-56 Rollover Nozzle Head



- Brass body
- 3600 PSI
- 8 GPM
- 300°F
- Glass-filled polyamide cover
- 1/4" FPT inlet & outlet

Part No.	Original No.	Description
8.712-411.0	901183	Rollover Nozzle Head

Part No. 4-pk	Nozzle Size	Part No. 5-pk
8.726-117.0	3.0	9.104-024.0
9.104-028.0	3.25	9.104-016.0
8.726-119.0	3.5	8.726-128.0
8.726-120.0	4.0	9.104-030.0
8.726-121.0	4.5	8.726-130.0
8.726-122.0	5.0	8.726-131.0
8.726-123.0	5.5	8.726-132.0
8.726-124.0	6.0	8.726-133.0
8.726-125.0	6.5	8.726-134.0

**The HOTSY Pump - Engineered for durability and performance.
Provides 3 times longer seal life.**



Hotsy Pumps featuring NESTechnology™

What is NESTechnology™? It stands for Nested Seal Technology, where the pump actually “nests” the seals of the pump’s high-pressure packing assembly in place, supporting the side walls, and resulting in greatly increased seal life.

The unique technology of the nesting assembly includes new high and low-pressure U-shaped seals surrounded by thicker brass pressure rings. This provides better wall support while withstanding higher water temperatures. This results in Hotsy pumps having 3 times the seal life over similar pumps in the industry.

- Extended time between seal replacement, greatly reducing maintenance costs.
- Teflon bronze rings support the U-Seal to prevent premature wear and loss of pressure.
- The low-pressure U-Seal has a unique double lip to provide for greater suction and less chance of water leakage.
- Increased wall thickness of the brass pressure rings resist cracking and provide a solid foundation for the seals.
- The nesting assembly is stronger and holds up better to spikes in water pressure, which occur every time the gun is triggered.
- Existing Hotsy pumps can be upgraded to utilize NESTechnology’s unique nesting assembly. All parts are interchangeable, and fit within the brass manifold.
- Seals are rated for temperatures up to 185°F.

Seals are a wear item in a pump because of the intense pressure they are subjected to. Hotsy’s nested seal technology holds up better, and has improved the seal life by changing the geometry of the packing assembly and providing greater support to the seals. The end result is a high-performance pump with extended service life.

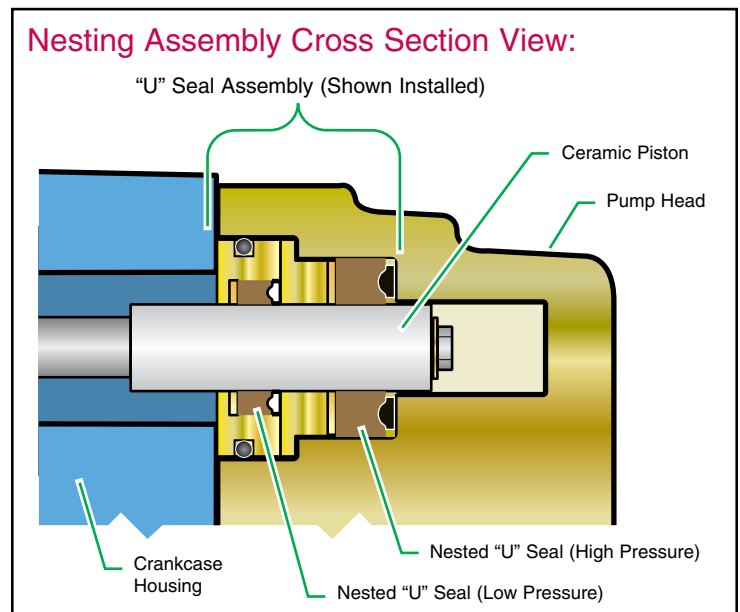

HOTSY BRANDED PARTS

The Hotsy Pump's rugged design features many benefits:

- Four frame sizes: one duplex, and three triplex sizes - small, medium, large
- Externally accessible check valves
- Two inlet and discharge ports facilitate system installation
- Anodized aluminum crankcase
- Polished ceramic plungers reduce seal wear
- Oversized crankshaft and connecting rods
- Heavy-duty roller bearings or heavy-duty tapered roller bearings
- Internally-ported, self-lubricating seals
- Pumps available for pulley, direct or gear-reducer drive
- 7-year warranty on the oil-end of the pump

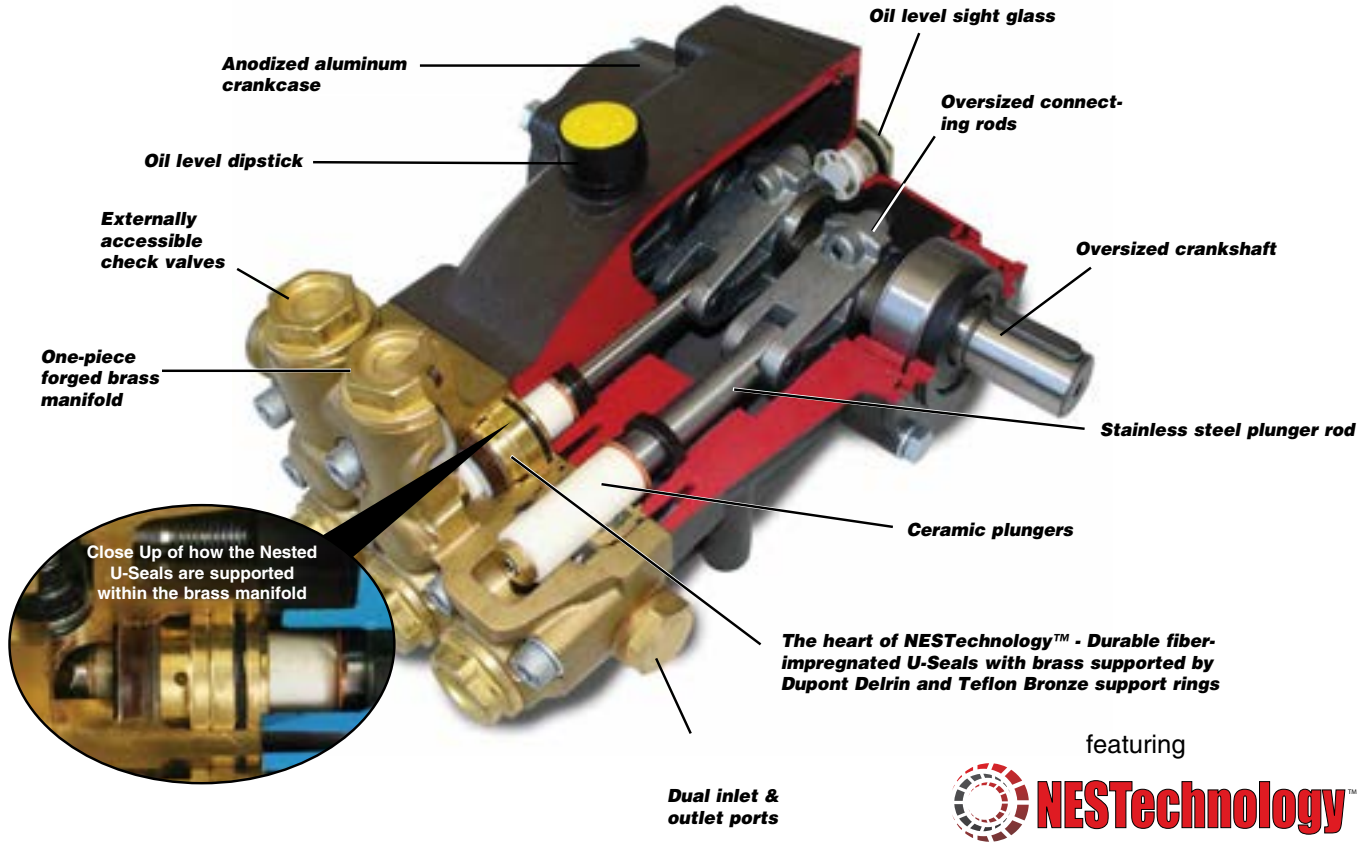

featuring



DUPLEX

DUPLEX SERIES: Direct Drive

Part No.	Model/Orig. No.	GPM	PSI	HP	RPM	Shaft	Weight
8.904-909.0	HHC165L.1	2.2	1500	2.3	1725	5/8" Hollow	13 lbs
8.904-915.0	HHC165R.1	2.2	1500	2.3	1725	5/8" Hollow	13 lbs
8.715-243.0	HHC168R.1	2.2	1500	2.3	1725	5/8" Hollow	13 lbs

HOTSY Pumps (continued)



HS.3

HS.3 SERIES: Direct Drive

Part No.	Model	GPM	PSI	HP	RPM	Shaft	Weight
8.751-182.0	HS3040G.3	3.0	4000	11.5	3400	1" Hollow	23 lbs
8.751-183.0	HS3540G.3	3.5	4000	13.5	3400	1" Hollow	23 lbs
8.751-184.0	HS4040G.3	4.0	4000	15.4	3400	1" Hollow	23 lbs
8.751-185.0	HS5030G.3	5.0	3000	15.4	3400	1" Hollow	23 lbs



HP

HP SERIES: Direct Drive

Part No.	Model/Orig. No.	GPM	PSI	HP	RPM	Shaft	Weight
8.923-771.0	HP2535G	2.5	3500	6.0	3400	3/4" Hollow	16.75 lbs
8.923-772.0	HP3035G	3.0	3500	7.2	3400	3/4" Hollow	16.75 lbs
8.923-773.0	HP3035G1	3.0	3500	7.2	3400	1" Hollow	18 lbs
8.923-774.0	HP3535G1	3.5	3500	8.4	3400	1" Hollow	18 lbs
8.923-775.0	HP4035G1	4.0	3000	9.6	3400	1" Hollow	18 lbs



HF

HF SERIES: Direct Drive

Part No.	Model/Orig. No.	GPM	PSI	HP	RPM	Shaft	Weight
8.923-776.0	HF2030F	2.1	3000	4.3	3450	5/8" Hollow	17 lbs
8.923-777.0	HF2030S	2.1	3000	4.3	1725	5/8" Hollow	17 lbs
8.923-778.0	HF2830F	2.8	3000	5.8	3450	5/8" Hollow	17 lbs
8.923-779.0	HF2830S	2.8	3000	5.8	1725	5/8" Hollow	17 lbs
8.923-780.0	HF3530F	3.5	3000	7.2	3450	5/8" Hollow	17 lbs
8.928-275.0	HF2030SL	2.1	3000	4.3	1725	5/8" Hollow	17 lbs

FasPump Quick Change Pump Assemblies

Includes a pump, uploader, thermal protector, by-pass loop hose, garden hose inlet with filter, and quick connect plug, making them easy to install.



Part No.	Description
8.924-434.0	Pump Assy, LP3035G, Direct, 3.0 GPM, 3500 PSI, 3.4" Hollow Shaft, 3400 RPM, VTR3
8.924-435.0	Pump Assy, LP3535G1, Direct, 3.5 GPM, 3500 PSI, 1" Hollow Shaft, 3400 RPM, VTR3
8.924-436.0	Pump Assy, LS4040G.3, Direct, 4.0 GPM, 4000 PSI, 1" Hollow Shaft, 3400 RPM, VTR3
8.924-437.0	Pump Assy, LB3030R, Belt, 3.0 GPM, 3000 PSI, 24mm Solid Shaft, 1650 RPM, VTR3
8.924-438.0	Pump Assy, LM3540R.3, Belt, 3.5 GPM, 4000 PSI, 24mm Solid Shaft, 1850 RPM, VTR3
8.924-439.0	Pump Assy, LM3840R.3, Belt, 3.8 GPM, 4000 PSI, 24mm Solid Shaft, 1740 RPM, VTR3

HOTSY Pumps (continued)



HX

HX SERIES: Belt Drive

Part No.	Model/Orig. No.	GPM	PSI	HP	RPM	Shaft	Weight
8.920-583.0	HX5843R.2	5.8	4350	17.3	1740	25mm Right	38 lbs
8.920-584.0	HX8043R.2	8.0	4350	23.8	1740	25mm Right	38 lbs
8.920-585.0	HX9536R.2	9.5	3625	16.4	1740	25mm Right	38 lbs
8.920-586.0	HX9536L.2	9.5	3625	23.6	1740	25mm Left	38 lbs
8.920-587.0	HX1036R.2	10.4	3625	23.6	1740	25mm Right	38 lbs
8.920-588.0	HX1036L.2	10.4	3625	25.8	1740	25mm Left	38 lbs



HB

HB SERIES: Belt Drive

Part No.	Model/Orig. No.	GPM	PSI	HP	RPM	Shaft	Weight
8.923-767.0	HB3030R	3.0	3000	6.2	1650	24mm	14.5 lbs
8.923-768.0	HB3030L	3.0	3000	6.2	1650	24mm	14.5 lbs
8.923-769.0	HB4025R	4.0	2500	6.8	1550	24mm	14.5 lbs
8.923-770.0	HB4025L	4.0	2500	6.8	1550	24mm	14.5 lbs



HX5450

HX5450 SERIES: Belt Drive

Part No.	Model/Orig. No.	GPM	PSI	HP	RPM	Shaft	Weight
8.921.659.0	HX5450R	5.4	5000	18.3	1740	24mm Right	43 lbs
8.921.660.0	HX5450L	5.4	5000	18.3	1740	24mm Left	43 lbs



HM.3

HM.3 SERIES: Belt Drive

Part No.	Model/Orig. I No.	GPM	PSI	HP	RPM	Shaft	Weight
8.751-179.0	HM3540R.3	3.5	4000	9.5	1850	24mm Right	21 lbs
8.751-180.0	HM4035R.3	4.8	3500	11.5	1500	24mm Right	21 lbs
8.751-181.0	HM4035L.3	4.8	3500	11.5	1500	24mm Left	21 lbs
8.923-100.0	HM4031R.3	4.0	3000	8.2	1725	24mm Right	21 lbs
8.923-101.0	HM4031L.3	4.0	3000	8.2	1725	24mm Left	21 lbs
8.923-165.0	HM4030R.3	4.0	3000	8.2	1000	24mm Right	21 lbs
8.923-166.0	HM4030L.3	4.0	3000	8.2	1000	24mm Left	21 lbs



HT

HT SERIES: Belt Drive

Part No.	Model/Orig. I No.	GPM	PSI	HP	RPM	Shaft	Weight
8.921-718.0	HT4540.R.2	4.5	4000	12.3	1360	25mm Right	33 lbs
8.921-719.0	HT4540.L.2	4.5	4000	12.3	1360	25mm Left	33 lbs
8.921-720.0	HT6036.R.2	6.0	3600	14.7	1450	25mm Right	33 lbs
8.921-721.0	HT6036.L.2	6.0	3600	14.7	1450	25mm Left	33 lbs

HOTSY Pump Repair Kit Selection Chart



Use the selection chart below to find the correct repair kits for the specific Hotsy Pump Model.

Pump Model	Seal Type	Seal Kit (qty / pump)	Complete Seal Kit (qty / pump)	Valve Kit (qty / pump)	Plunger Oil Seal Kit (qty / pump)	Ceramic Sleeve (qty / pump)
H300	U	8.725-362.0 (1)	8.725-407.0 (3)	8.717-584.0 (6)	8.717-618.0 (1)	8.717-617.0 (3)
H300A	U	8.725-362.0 (1)	8.725-407.0 (3)	8.717-584.0 (6)	8.717-618.0 (1)	8.717-617.0 (3)
H300R	U	8.725-362.0 (1)	8.725-407.0 (3)	8.717-584.0 (6)	8.717-618.0 (1)	8.717-617.0 (3)
H400	U	8.725-362.0 (1)	8.725-407.0 (3)	8.717-584.0 (6)	8.717-618.0 (1)	8.717-617.0 (3)
H400A	U	8.725-362.0 (1)	8.725-407.0 (3)	8.717-584.0 (6)	8.717-618.0 (1)	8.717-617.0 (3)
H400R	U	8.725-362.0 (1)	8.725-407.0 (3)	8.717-584.0 (6)	8.717-618.0 (1)	8.717-617.0 (3)
H450	U	8.916-488.0 (1)	8.725-404.0 (3)	8.717-584.0 (6)	8.717-585.0 (1)	8.717-586.0 (3)
H500	U	8.916-487.0 (1)	8.725-405.0 (3)	8.717-584.0 (6)	8.717-585.0 (1)	8.717-601.0 (3)
H600	U	8.725-364.0 (1)	8.725-401.0 (3)	8.717-584.0 (6)	8.717-585.0 (1)	9.802-614.0 (3)
H700	U	8.725-364.0 (1)	8.725-401.0 (3)	8.717-584.0 (6)	8.717-585.0 (1)	9.802-614.0 (3)
HC165	U	8.725-362.0 (1)	8.725-408.0 (2)	8.717-584.0 (4)	8.717-587.0(1)	8.717-670.0 (2)
HC165R	U	8.725-362.0 (1)	8.725-408.0 (2)	8.717-584.0 (4)	8.717-587.0(1)	8.717-670.0 (2)
HC168R	U	8.717-623.0 (1)	8.717-671.0 (2)	8.717-584.0 (4)	8.717-587.0(1)	8.717-670.0 (2)
HC205AL	U	8.725-360.0 (1)	8.725-415.0 (3)	8.717-584.0 (6)	8.717-585.0 (1)	8.717-632.0 (3)
HC215	U	8.725-362.0 (1)	8.725-407.0 (3)	8.717-584.0 (6)	8.717-585.0 (1)	8.717-617.0 (3)
HC235	U	8.725-362.0 (1)	8.725-407.0 (3)	8.717-584.0 (6)	8.717-585.0 (1)	8.717-617.0 (3)
HC240	U	8.725-362.0 (1)	8.725-407.0 (3)	8.717-584.0 (6)	8.717-585.0 (1)	8.717-617.0 (3)
HC240A	U	8.725-360.0 (1)	8.725-415.0 (3)	8.717-584.0 (6)	8.717-585.0 (1)	8.717-632.0 (3)
HC280	U	8.725-362.0 (1)	8.725-407.0 (3)	8.717-584.0 (6)	8.717-585.0 (1)	8.717-617.0 (3)
HC340R	U	8.725-360.0 (1)	8.725-418.0 (3)	8.717-590.0 (6)	8.717-618.0 (1)	9.803-935.0 (3)
HC450	U	8.725-362.0 (1)	8.725-407.0 (3)	8.717-584.0 (6)	8.717-618.0 (1)	8.717-617.0 (3)
HC450A	U	8.725-362.0 (1)	8.725-407.0 (3)	8.717-584.0 (6)	8.717-618.0 (1)	8.717-617.0 (3)
HC450R	U	8.725-362.0 (1)	8.725-407.0 (3)	8.717-584.0 (6)	8.717-618.0 (1)	8.717-617.0 (3)
HC460AL	U	8.725-362.0 (1)	8.725-407.0 (3)	8.717-584.0 (6)	8.717-618.0 (1)	8.717-617.0 (3)
HC460AR	U	8.725-362.0 (1)	8.725-407.0 (3)	8.717-584.0 (6)	8.717-618.0 (1)	8.717-617.0 (3)
HC460L	U	8.725-362.0 (1)	8.725-407.0 (3)	8.717-584.0 (6)	8.717-618.0 (1)	8.717-617.0 (3)
HC460R	U	8.725-362.0 (1)	8.725-407.0 (3)	8.717-584.0 (6)	8.717-618.0 (1)	8.717-617.0 (3)
HC500	U	8.725-362.0 (1)	8.725-407.0 (3)	8.717-584.0 (6)	8.717-618.0 (1)	8.717-617.0 (3)
HC500A	U	8.725-362.0 (1)	8.725-407.0 (3)	8.717-584.0 (6)	8.717-618.0 (1)	8.717-617.0 (3)
HC500R	U	8.725-362.0 (1)	8.725-407.0 (3)	8.717-584.0 (6)	8.717-618.0 (1)	8.717-617.0 (3)
HC600	U	8.916-488.0 (1)	8.725-404.0 (3)	8.717-584.0 (6)	8.717-585.0 (1)	8.717-586.0 (3)
HC800	U	8.725-364.0 (1)	8.725-401.0 (3)	8.717-584.0 (6)	8.717-585.0 (1)	9.802-614.0 (3)
HC930R	U	8.916-488.0 (1)	8.725-404.0 (3)	8.717-591.0 (6)	8.717-585.0 (1)	8.717-586.0 (3)
HC940R	U	8.916-487.0 (1)	8.725-405.0 (3)	8.717-589.0 (6)	8.717-585.0 (1)	8.717-601.0 (3)
HC950R	U	8.725-364.0 (1)	8.725-401.0 (3)	8.717-589.0 (6)	8.717-585.0 (1)	9.802-614.0 (3)
HD3025	U	8.725-356.0 (1)	8.725-357.0 (3)	9.803-936.0 (1)	9.803-937.0 (1)	9.803-935.0 (3)
HD3030H	U	9.804-076.0 (1)	9.804-077.0 (3)	9.803-936.0 (1)	9.803-937.0 (1)	9.803-934.0 (3)
HD4020	U	8.725-356.0 (1)	8.725-357.0 (3)	9.803-936.0 (1)	9.803-937.0 (1)	9.803-935.0 (3)
HE2020F	U	8.725-354.0 (1)	8.725-355.0 (3)	9.803-936.0 (1)	9.803-937.0 (1)	9.803-934.0 (3)
HE2020S	U	8.725-356.0 (1)	8.725-357.0 (3)	9.803-936.0 (1)	9.803-937.0 (1)	9.803-935.0 (3)
HE2825F	U	8.725-354.0 (1)	8.725-355.0 (3)	9.803-936.0 (1)	9.803-937.0 (1)	9.803-934.0 (3)
HE2825S	U	8.725-356.0 (1)	8.725-357.0 (3)	9.803-936.0 (1)	9.803-937.0 (1)	9.803-935.0 (3)
HE3525F	U	8.725-354.0 (1)	8.725-355.0 (3)	9.803-936.0 (1)	9.803-937.0 (1)	9.803-934.0 (3)
HG2530G	U	8.725-354.0 (1)	8.725-355.0 (3)	9.803-936.0 (1)	9.803-937.0 (1)	9.803-934.0 (3)
HG3030G	U	8.725-354.0 (1)	8.725-355.0 (3)	9.803-936.0 (1)	9.803-937.0 (1)	9.803-934.0 (3)
HG3035G	U	8.725-354.0 (1)	8.725-355.0 (3)	9.803-936.0 (1)	9.803-937.0 (1)	9.803-934.0 (3)
HG3535G	U	8.725-354.0 (1)	8.725-355.0 (3)	9.803-936.0 (1)	9.803-937.0 (1)	9.803-934.0 (3)
HG4030G	U	8.725-354.0 (1)	8.725-355.0 (3)	9.803-936.0 (1)	9.803-937.0 (1)	9.803-934.0 (3)
HH5050	U	9.804-492.0 (1)	9.804-493.0 (3)	9.802-604.0 (1)	9.802-606.0 (1)	9.802-629.0 (3)
HHC300AR	U	8.725-362.0 (1)	8.725-407.0 (3)	8.717-584.0 (6)	8.717-618.0 (1)	8.717-617.0 (3)
HHC500AR	U	8.725-362.0 (1)	8.725-407.0 (3)	8.717-584.0 (6)	8.717-618.0 (1)	8.717-617.0 (3)
HHC950AR	U	8.725-364.0 (1)	8.725-401.0 (3)	8.717-589.0 (6)	8.717-585.0 (1)	9.802-614.0 (3)
HHS335CR	U	8.725-358.0 (1)	8.725-417.0 (3)	8.717-590.0 (6)	8.717-618.0 (1)	9.803-934.0 (3)

HOTSY Pump Repair Kit Selection Chart, continued



Pump Model	Seal Type	Seal Kit (qty / pump)	Complete Seal Kit (qty / pump)	Valve Kit (qty / pump)	Plunger Oil Seal Kit (qty / pump)	Ceramic Sleeve (qty / pump)
HM3540	U	8.725-358.0 (1)	8.725-359.0 (3)	9.802-603.0 (1)	9.802-609.0 (1)	8.933-023.0 (3)
HM4035	U	8.725-360.0 (1)	8.725-361.0 (3)	9.802-603.0 (1)	9.802-609.0 (1)	8.933-023.0 (3)
HS3040G	U	8.725-358.0 (1)	8.725-359.0 (3)	9.802-603.0 (1)	9.802-609.0 (1)	8.933-023.0 (3)
HS330R	U	8.725-358.0 (1)	8.725-417.0 (3)	8.717-590.0 (6)	8.717-618.0 (1)	9.803-934.0 (3)
HS335R	U	8.725-358.0 (1)	8.725-359.0 (3)	9.802-603.0 (1)	8.717-618.0 (1)	8.933-023.0 (3)
HS340R	U	8.717-646.0 (1)	8.717-647.0 (3)	8.717-590.0 (6)	8.717-618.0 (1)	9.803-934.0 (3)
HS3540G	U	8.725-358.0 (1)	8.725-359.0 (3)	9.802-603.0 (1)	9.802-609.0 (1)	8.933-023.0 (3)
HS4040G	U	8.725-358.0 (1)	8.725-359.0 (3)	9.802-603.0 (1)	9.802-609.0 (1)	8.933-023.0 (3)
HS5030G	U	8.725-358.0 (1)	8.725-359.0 (3)	9.802-603.0 (1)	9.802-609.0 (1)	8.933-023.0 (3)
HX1025L	U	8.725-364.0 (1)	8.725-365.0 (3)	9.802-608.0 (1)	9.802-606.0 (1)	9.802-614.0 (3)
HX1025R	U	8.725-364.0 (1)	8.725-365.0 (3)	9.802-608.0 (1)	9.802-606.0 (1)	9.802-614.0 (3)
HX5050L	U	9.804-492.0 (1)	9.804-493.0 (3)	9.802-604.0 (1)	9.802-606.0 (1)	9.802-629.0 (3)
HX5050R	U	9.804-492.0 (1)	9.804-493.0 (3)	9.802-604.0 (1)	9.802-606.0 (1)	9.802-629.0 (3)
HX8030L	U	8.725-364.0 (1)	8.725-365.0 (3)	9.802-608.0 (1)	9.802-606.0 (1)	9.802-614.0 (3)
HX8030R	U	8.725-364.0 (1)	8.725-365.0 (3)	9.802-608.0 (1)	9.802-606.0 (1)	9.802-614.0 (3)
HM4035.3	U	8.725-360.0 (3)	8.725-361.0 (1)	9.802-603.0 (6)	9.802-609.0 (3)	8.751-237.0 (3)
HM3540.3	U	8.725-358.0 (3)	8.725-359.0 (1)	9.802-603.0 (6)	9.802-609.0 (3)	8.933-023.0 (3)
HH306R.2	U	8.725-407.0 (3)	8.725-362.0 (1)	8.717-584.0 (6)	8.717-618.0 (3)	8.751-238.0 (3)
HH406R.2	U	8.725-407.0 (3)	8.725-362.0 (1)	8.717-584.0 (6)	8.717-618.0 (3)	8.751-238.0 (3)
HH456R.2	U	8.725-407.0 (3)	8.725-362.0 (1)	8.717-584.0 (6)	8.717-618.0 (3)	8.751-238.0 (3)
HH466R.2	U	8.725-407.0 (3)	8.725-362.0 (1)	8.717-584.0 (6)	8.717-618.0 (3)	8.751-238.0 (3)
HH506R.2	U	8.725-407.0 (3)	8.725-362.0 (1)	8.717-584.0 (6)	8.717-618.0 (3)	8.751-238.0 (3)
HS3040G.3	U	8.725-358.0 (3)	8.725-359.0 (1)	9.802-603.0 (6)	9.802-609.0 (3)	8.933-023.0 (3)
HS3540G.3	U	8.725-358.0 (3)	8.725-359.0 (1)	9.802-603.0 (6)	9.802-609.0 (3)	8.933-023.0 (3)
HS4040G.3	U	8.725-358.0 (3)	8.725-359.0 (1)	9.802-603.0 (6)	9.802-609.0 (3)	8.933-023.0 (3)
HS5030G.3	U	8.725-358.0 (3)	8.725-359.0 (1)	9.802-603.0 (6)	9.802-609.0 (3)	8.933-023.0 (3)
HX5843.2	U	8.752-843.0 (3)	8.752-849.0 (1)	8.752-853.0 (6)	8.752-835.0 (6)	8.752-838.0 (3)
HX8043.2	U	8.752-843.0 (3)	8.752-849.0 (1)	8.752-853.0 (6)	8.752-835.0 (6)	8.752-838.0 (3)
HX9536.2	U	8.752-844.0 (3)	8.752-850.0 (1)	8.752-853.0 (6)	8.752-835.0 (6)	8.752-938.0 (3)
HX1036.2	U	8.752-844.0 (3)	8.752-850.0 (1)	8.752-853.0 (6)	8.752-835.0 (6)	8.752-939.0 (3)
HT4540.2	U	8.753-821.0 (3)	8.753-822.0 (1)	8.753-824.0 (6)	8.752-835.0 (3)	8.753-823.0 (3)
HT6036.2	U	8.753-821.0 (3)	8.753-822.0 (1)	8.753-824.0 (6)	8.752-835.0 (3)	8.753-823.0 (3)
HB3030	U	8.754-856.0 (3)	8.754-857.0 (1)	8.754-859.0 (6)	9.803-937.0 (3)	8.754-858.0 (1)
HB4025	U	8.754-856.0 (3)	8.754-857.0 (1)	8.754-859.0 (6)	9.803-937.0 (3)	8.754-858.0 (1)
HF2030F	U	8.754-860.0 (3)	8.754-861.0 (1)	8.754-859.0 (6)	9.803-937.0 (3)	8.754-862.0 (1)
HF2030S	U	8.754-856.0 (3)	8.754-857.0 (1)	8.754-859.0 (6)	9.803-937.0 (3)	8.754-858.0 (1)
HF2830F	U	8.754-860.0 (3)	8.754-861.0 (1)	8.754-859.0 (6)	9.803-937.0 (3)	8.754-862.0 (1)
HF2830S	U	8.754-856.0 (3)	8.754-857.0 (1)	8.754-859.0 (6)	9.803-937.0 (3)	8.754-858.0 (1)
HF3530F	U	8.754-860.0 (3)	8.754-861.0 (1)	8.754-859.0 (6)	9.803-937.0 (3)	8.754-862.0 (1)
HP2535G	U	8.754-860.0 (3)	8.754-861.0 (1)	8.754-859.0 (6)	9.803-937.0 (3)	8.754-862.0 (1)
HP3035G	U	8.754-860.0 (3)	8.754-861.0 (1)	8.754-859.0 (6)	9.803-937.0 (3)	8.754-862.0 (1)
HP3035G1	U	8.754-860.0 (3)	8.754-861.0 (1)	8.754-859.0 (6)	9.803-937.0 (3)	8.754-862.0 (1)
HP3535G1	U	8.754-860.0 (3)	8.754-861.0 (1)	8.754-859.0 (6)	9.803-937.0 (3)	8.754-862.0 (1)
HP4035G1	U	8.754-860.0 (3)	8.754-861.0 (1)	8.754-859.0 (6)	9.803-937.0 (3)	8.754-862.0 (1)

HOTSY Pump Seal Kits



Part No.	Kit Description
8.717-623.0	20mm 2 CYL
8.717-646.0	15mm 3 CYL
8.725-354.0	15mm
8.725-356.0	18mm
8.725-358.0	15mm 3 CYL
8.725-360.0	18mm 3 CYL
8.725-362.0	20mm 3 CYL
8.725-364.0	25mm 3 CYL
8.916-487.0	22mm 3 CYL
8.916-488.0	20mm 3 CYL
9.804-076.0	15mm Hot Water
9.804-492.0	18mm

Complete Seal Kits



Part No.	Kit Description
8.717-647.0	15mm 3 CYL
8.717-671.0	20mm 2 CYL
8.725-355.0	15mm
8.725-357.0	18mm
8.725-359.0	25mm
8.725-361.0	18mm
8.725-365.0	25mm
8.725-401.0	25mm 3 CYL
8.725-404.0	20mm 3 CYL
8.725-405.0	22mm 3 CYL
8.725-407.0	20mm 3 CYL
8.725-408.0	20mm 2 CYL
8.725-415.0	18mm 3 CYL
8.725-417.0	15mm 3 CYL
8.725-418.0	18mm 3 CYL
9.804-077.0	15mm Hot Water
9.804-493.0	18mm Hot Water

Ceramic Plunger Kits



Part No.	Orig. No.	Description
9.803-934.0	753040	15mm
9.803-935.0	753107	18mm
8.717-586.0	877651	20mm
9.802-614.0	877652	25mm
8.717-617.0	877656	20mm
8.717-601.0	877659	22mm
8.717-632.0	877674	18mm
8.717-670.0	877684	20mm
9.802-614.0	70-260209	25mm
8.933-023.0	70-260823	15mm
9.802-629.0	70-261217	18mm
8.751-238.0		20mm

Maintenance Kit



Part No.	Orig. No.	Kit Description
8.756-717.0		Normal Maintenance Kit

Valve Kits



Part No.	Orig. No.	Kit Description
8.717-590.0	753039	HC340R,HHS335CR,HS330R, HS340R - Inc (1)
8.717-589.0	753069	HC940,HC 950, HHC950AR - Inc (6)
8.717-591.0	753110	HC930 Series - Inc (1)
8.717-584.0	877648	10mm - Inc (1)
9.802-603.0	70-260007	HM,HS Series - Inc (6)
9.802-604.0	70-260018	HH, HX series Inc (6)
9.802-608.0	70-260025	HX Series - Inc (6)
9.803-936.0	70-260028	HD, HE, HG Series - Inc (6)

HOTSY Pump Tool Kits



A must for every service department.

Save time using the right tool for the job. The HOTSY Pump Tool Kit includes:



- 6mm Allen Wrench
- 14mm Allen Wrench
- Plastic Covered Thin Blade Screwdriver
- Plastic Hammer
- Seal Extractor
- Two Piece Inserter for Sleeves
- Two Part Seal Inserter for Plunger Rods
- Crankshaft Seal Inserter
- Two Part Seal Inserter for Plunger Rods
- Crankshaft Seal Inserter
- Plastic Tool Box
- Pliers
- Seal Extractor



Part No.	Original No.	Kit Description
9.802-953.0	918430	13 Piece Hotsy Pump Tool Kit
9.802-568.0	959260	Pliers, Seal Extractor

Plunger Oil Seal Kits



Part No.	Original no.	Description
8.717-585.0	877653	H, HC Series - See Selection Chart
8.717-618.0	877655	H, HC, HS Series - See Selection Chart
8.717-587.0	877687	HC165, HC168 Series
8.756-717.0		Oil Seal Maintenance Kit
9.802-606.0	70-260023	HH, HX Series
9.802-609.0	70-260027	HM, HS Series
9.803-937.0	70-260826	HD, HE, HG Series

HOTSY BRANDED PARTS

Pump Oil



- Formulated to exceed the factory specifications for HOTSY and other high pressure pumps.
- Non-detergent, non-foaming

Part No.	Description
8.923-422.0	32 oz Bottle

Downstream Chemical Injectors



Adjustable Injector



Fixed Injector

- Applies detergent while by-passing vital machine components

Part No.	Original No.	Description
Adjustable		
9.802-956.0	873579	Hot Water 2.1mm 3/8" M x 3/8" M
8.709-428.0	873580	Cold Water 2.1mm 3/8" M x 3/8" M
8.709-429.0	873582	Cold Water 2.3mm 3/8" M x 3/8" M
Fixed - Cold Water		
8.709-419.0	873594	1.8mm 3/8" F x 3/8" M
9.802-957.0	873591	2.1mm 3/8" M x 3/8" M
8.709-421.0	722400	2.1mm 3/8" F x 3/8" M
8.709-422.0	722436	2.1mm 3/8" qc skt x 3/8" qc plug
8.709-420.0	875760	2.3mm 3/8" F x 3/8" M
8.709-423.0	722429	1.8mm 3/8" M x 3/8" M 2-3 GPM Ceramic Check
8.709-424.0	722430	2.1mm 3/8" M x 3/8" M 3-5 GPM Ceramic Check
Repair Kits		
8.717-663.0	877665	Repair Kit 873579, 873591
8.718-494.0	753048	Repair Kit 722429, 722430
8.718-495.0	753121	Repair Kit 873580,873582,873594, 722400,722436,875760
8.717-664.0	908285	Orifice, Blank

Inlet Chemical Injector



- Two adjusting knobs for incoming water pressure and detergent metering

Part No.	Description
9.803-275.0	Hotsy Dual-Adjusting Injector
8.700-290.0	Repair Kit

Hotsy Unloaders



8.715-491.0



8.715-505.0

- Head mount or remote
- Lock device
- Hotsy proven performer's

Part No.	Orig. No.	Description	GPM	PSI
8.715-469.0	921501	XSM w/o Knob 1/4 Bypass	6.6	500
8.715-498.0	921467	XSM w/o Knob 1/4 Bypass	6.6	4500
8.707-351.0	921505	XSM w/o Knob 3/8 Bypass	6.6	2500
8.715-502.0	921462	H/M Duplex Pumps	6.6	1000
8.715-500.0	921378	H/M High Temp O-rings	6.6	600
8.715-491.0	921460	H/M Sml & Med Triplex Pumps	6.6	3000
8.715-494.0	921461	H/M Sml & Med Triplex w/ Hi Flow Banjo	6.6	3000
8.715-493.0	921464	H/M SST Pumps	6.6	3000
8.715-490.0	921465	H/M SST w/ Hi Flow Banjo Bolts	6.6	3000
8.715-499.0	921300	SM w/o Knob	6.6	2200
8.715-492.0	921304	SM w/o Knob	6.6	1000
8.715-496.0	971179	SM w/o Knob	6.6	1500
8.715-495.0	971582	LG w/ Knob	8.0	1500
8.715-504.0	971581	LG w/ Knob	8.0	2200
8.715-503.0	971580	LG w/ Knob	8.0	3000
8.715-505.0	971555	LG w/ Knob (w/o Spacer)	8.0	3000
8.715-509.0	921391	XLG w/ Knob	13.2	2000
8.715-508.0	921390	XLG w/ Knob	13.2	3000
9.802-363.0	5-3029	VB55 for Hotsy HM,HS	8	3650
9.802-361.0	921809	VB55 w/1/8" Bore for easy start	8	3200
9.803-899.0	5-3329	VBA35 for Hotsy HG, HD, HE	6.6	3500
9.803-900.0	5-3330	VBA35 for Hotsy HM,HS	6.6	3500

Pressure Relief Valves



8.718-496.0



8.707-332.0

Part No.	Orig. I No.	PSI
8.707-337.0	971204	500
8.707-332.0	971181	1000
8.707-336.0	971187	1500
8.718-496.0	971182	2000
8.707-274.0	921468	2200
8.707-335.0	971185	2500
8.711-231.0	971183	3000
8.707-334.0	971184	3500
8.707-258.0	921440	150 PSI/ 210°F

Thermostats



8.712-191.0



8.716-102.0

Part No.	Orig. No.	Description
8.712-191.0	955930	240°F 1M Probe
8.712-195.0	955940	240°F 2M Probe

For use with above:

Part No.	Orig. No.	Description
8.712-190.0	915390	Mounting Plate
8.718-779.0	735321	Screws (2), Mounting Plate
8.712-189.0	835150	Dial
8.707-286.0	389522	Well
9.804-564.0	735226	Screw, Well

Part No.	Orig. No.	Description
8.716-102.0	950513	Temp Control Bulb 200°F
8.712-199.0	950509	Temp Control w/ Bulb
8.712-200.0	950516	-100 + 400 Fenwall
8.712-206.0	875707	Switch Therm NC 140°F

Float Tank



9.804-042.0

- Heavy 3/16" durable plastic

Part No.	Orig. No.	Description
9.804-042.0	890880	2.5 gal w/o Adapter
8.706-642.0	890760	4.0 gal w/ Cover
8.706-643.0	952721	8.0 gal, 7-3/4" x 20-3/4" x 15"

Flow Switch



Part No.	Original No.	Description
8.716-139.0	950499	FS 1 McDonnell - 1/2" FPT
8.716-138.0	950496	FS 6 McDonnell - 1" FPT

Pressure Switch



8.716-129.0

- Activated pressure 375 PSI

Part No.	Orig. No.	Description	PSI	Amp	Voltage
8.716-129.0	875651	Hotsy	4000	15	250
8.712-267.0	885680	Hotsy	5800	15	250
8.717-667.0*	753134	Repair Kit-Seal			
8.717-668.0*	753228	Repair Kit-Plunger			
8.717-256.0*	875653	Micro Switch			

* Repair parts only fit the 8.716-129.0.

Detergent Flow Meter



- 100 PSI working pressure
- 150°
- Measures detergent / water flow ratio

Part No.	Orig. No.	Description
8.712-139.0	886539	Up to 100 PSI @ 150°F

HOTSY BRANDED PARTS

Geared Reduction for Hotsy Pumps



Part No.	Engine Shaft	Pump Shaft	Weight	Gear Ratio	Engine Power
B5					
8.749-922.0	3/4 in.	24 mm	74.1 oz.	2.3:1	6.5 HP
B10					
8.749-923.0	1 in.	24 mm	193.3 oz.	2.176:1	7-10 HP
B18					
8.715-342.0	1 in.	24 mm	139.3 oz.	2.176:1	11-18 HP
8.749-924.0	1-1/8 in.	24 mm	139.3 oz.	2.176:1	11-18 HP
8.749-925.0	0.984 in.	24 mm	139.3 oz.	2.176:1	11-18 HP
8.715-344.0	1 in.	25 mm	139.3 oz.	2.176:1	11-18 HP
B18H					
8.749-926.0	1 in.	24 mm	155.2 oz.	2.176:1	11-18 HP

Coil Insulation



873750

- Refractory Grade Ceramic
- Retains heat inside coil for better fuel efficiency and paint protection

Part No.	Original No.	Description
8.717-412.0	268015	Cerafelt 24 x 56
8.717-413.0	268016	Cerafelt 6 x 56
8.717-451.0	873757	Cerafelt 1/2 x 24, Bulk/sqft
8.717-452.0	873762	Cerafelt 1 x 24, Bulk/sqft
8.717-414.0	268017	Fiberglass 18 OD x 10.3 ID
8.717-442.0	873749	Fiberglass 18 OD x 8.0 ID
8.717-446.0	873751	Fiberglass 29 x 58
9.802-908.0	873776	Fiberglass 10 x 52
8.717-438.0	873777	Fiberglass 22.5 x 52
9.802-903.0	873778	Fiberglass 16 OD x 4.5
9.802-904.0	873779	Fiberglass 16 OD x 8.3
8.717-445.0	873786	Fiberglass 18 OD x 10
8.717-450.0	722418	Fiberglass 8 x 17.5
9.802-587.0	722423	Fiberglass TBG 50 ID
8.717-449.0	722411	Fiberglass 16 OD x 10
8.717-441.0	873750	Tophead 18 OD x 4.0 ID

Coils



- Heavy-duty schedule 80 carbon steel pipe
- Best warranty in the industry
- Sized to water flow for maximum heat rise
- Wound specifically for oil and gas fired applications

Part No.	Original No.	Description
Oil Fired		
8.925-135.0	226222	16", fits 444/550/660, 555, 560, 781, 871, 921, 965 Series
8.911-493.0	240839	fits 900/1000, 1400 Series
8.911-497.0*	240900	fits 3Z663/5Z021 Series
8.925-221.0	241100	fits 800E/950/810, 1260, 70, 80, 90 Series
8.911-499.0*	241119	fits 530, Sheetmetal Frame
8.911-500.0	241172	fits 520/540 Series
8.911-494.0	241207	fits 5000/9450, 5645, 5700 Series
8.911-502.0*	241291	fits 800 30" HGT
8.911-505.0*	241314	fits 530/610 Series, Angle Frame
Gas/Oil Fired		
8.911-496.0	241196	28" fits 9460 Series
Gas Fired		
8.925-215.0	241098	fits 900/1000, 1400 Series
8.911-501.0*	241173	fits 611/530 Series
8.911-495.0	241208	fits 5000 Series, 9452
8.911-503.0	241292	fits 800 30" HGT
8.911-504.0*	241313	fits 800 27" HGT
8.911-976.0*	241536	16" fits 551, 558, 559 Series
8.911-996.0*	240841	fits 771, 772

*Available from Springdale and Camas

Wayne Burners



Hotsy Hot Water Oil Fired Machines are now being built exclusively with Wayne Burners. Wayne Combustion has been building quality burners since 1928. They are known in the marketplace for superior reliability and ultra-high efficiency. The Wayne Burners have the following features:

- Lower Emissions
- Improved Efficiencies
- Positive flame retention
- Controlled Flame Pattern
- Low Nozzle Temperatures
- High static pressure overcomes adverse draft conditions for a better air/oil mixture



Part No.	Description	Operating Voltage	Air Cone	Fuel Pump Solenoid Voltage
8.756-181.0	MSR 3.75 1T	120V	6A	120V
8.756-253.0	MSR 3.75 1T	120V	7A	120V
8.756-254.0	MSR 3.75 1T	230V	7A	230V
8.756-413.0	EHASR 2T	120V	4A	120V
8.756-456.0	EHASR 1T	230V	7A	24V
8.756-480.0	EHASR 2T	12VDC	4A	12VDC
8.756-655.0	MSR 1T	12V	3A	12VDC
8.756-681.0	EHASR 1T	12VDC	4A	12V
8.756-703.0	EHASR 1T	120V	7A	120V
8.756-736.0	EHASR 2T	12VDC	4A	12VDC
8.756-756.0	EHASR 1T	12VDC	3A	12VDC
8.756-890.0	EHASR 2T	12VDC	4A	12V
8.756-921.0	EH 1.75 1T	120V	3.56" ID Flamelock	120V
8.756-922.0	EH 1.75 1T	230V	3.56" ID Flamelock	120V
8.754-264.0	Vertical Burner M/L	12VDC	3.73" ID Flamelock	12V
8.754-265.0	Vertical Burner M/L	12VDC	3.73" ID Flamelock	12V
8.754-792.0	Vertical Burner M/L	12VDC	3.73" ID Flamelock	12V
8.754-793.0	Vertical Burner M/L	12VDC	3.73" ID Flamelock	12V

Replacement Parts, Wayne	
8.700-822.0	FLEX COUPLING-F/307007 12V
8.700-776.0	COUPLING 5/16 x 1/2" FS
8.700-721.0	COUPLING FOR 079021X
8.756-715.0	COUPLING, "E" DC
8.756-438.0	FAN - 4.00"W X 6.25"D 1/2" BORE
8.756-674.0	FAN, 3.44"W X 4.25"D 5/16" BORE
8.756-730.0	FAN, 3.44"W X 4.75"D 5/16" BORE
8.756-726.0	FAN, 3.44"W X 5.25"D 5/16" BORE
8.756-677.0	FAN, 3.50"W X 5.75"D 1/2" BORE
8.700-728.0	BLOWERWHEEL EG1/MSR3.44x4.25STAR MET MTR
8.700-760.0	FUEL PUMP, SUNTEC A2VA-3106 230V SOL
8.756-290.0	FUEL PUMP, WCS - COMBO/W SOLENOID 120V
8.717-814.0	FUEL UNIT, SUNTEC A2VA-7916
8.756-437.0	PUMP - COMBO/W SOLENOID 12V/24V
9.107-507.0	IGNITOR
8.700-803.0	IGNITOR, 120V, BACK/M-MSR MOUNT
8.700-802.0	IGNITOR, 120V, SIDE/EH-EHA MOUNT

Replacement Parts, Wayne (cont)	
8.756-291.0	IGNITOR, BURNER, "E" 240 50-60
8.756-324.0	IGNITOR, BURNER, "M" 240 50-60
8.756-436.0	MOTOR, 1/4 120V 50-60HZ
8.756-716.0	MOTOR, 1/4 13.5VDC AMETEK
8.717-830.0	MOTOR, 1/8HP 1PH 230V 3450RPM
8.756-293.0	MOTOR, BURNER, 1/5 120V 50-60HZ
8.756-294.0	MOTOR, BURNER, 1/5 230V 50-60HZ
8.756-292.0	MOTOR, BURNER, 1/7 HP 120/60
8.700-739.0	BURNER MOT 12V-WH MSR DC FASCO

Replacement Parts, Hotsy	
8.919-050.0	Burner Housing Assembly - S
8.752-865.0	Burner Housing Assembly - M/L
8.700-758.0	Suntec Fuel Pump, 12-24V Sol
8.700-759.0	Suntec Fuel Pump, 120V Sol
8.700-760.0	Suntec Fuel Pump, 230V Sol
8.750-517.0	Burner Motor, 1/6 HP, 115V - S
8.750-518.0	Burner Motor, 1/6 HP, 230V - M/L
8.751-074.0	Burner Motor, 1/7 HP, 12VDC, Ametek
8.752-930.0	Burner Motor, 1/4 HP, 115V w/cap - M/L
8.752-931.0	Burner Motor, 1/4 HP, 230V w/cap - M/L
8.752-933.0	Burner Motor, 1/5 HP, 13.5 VDC - M/L
8.752-932.0	Burner Motor, 1/7 HP, 115V - M/L
8.750-543.0	Flex Coupling, 1/2" x 5/16"
8.753-061.0	Flex Coupling, 1/2" x 5/16" x 3 7/8"L
8.753-062.0	Flex Coupling, 5/16" x 5/16" x 3 7/8"L
8.750-520.0	Fan, 1/2 Bore - S
8.751-072.0	Fan, 5/16" Bore - S
8.752-928.0	Fan, 6.25 x 4.25 x 1/2 Bore - M/L
8.752-929.0	Fan, 6.25 x 4.25 x .313 Bore - M/L
8.750-547.0	Connector, 37 Degree Flare, 1/8" NPT, Long
8.750-545.0	Connector, 37 Degree Flare, 1/8" NPT
8.749-000.0	Fuel Line Assembly - S
8.752-934.0	Fuel Line Assembly - M
8.753-055.0	Fuel Line Assembly - L
8.750-539.0	Gasket, flange
8.750-526.0	Gun, Electrode / Nozzle, 3"
8.750-525.0	Gun, Electrode / Nozzle, 1"
8.750-778.0	Electrode Ignition
8.919-114.0	Burner Ignitor, 120V
8.919-115.0	Burner Ignitor, 230V
8.919-116.0	Burner Ignitor, 12VDC
8.918-454.0	Junction Box Gasket - S
8.752-922.0	Junction Box Gasket - M/L
8.920-654.0	Junction Box Cover - M/L
8.750-542.0	Junction Box Cover - S
8.751-342.0	Electrode, Ignition, DC
8.750-762.0	Coil, Solenoid, 230V - S
8.750-763.0	Coil, Solenoid, 115V - S
8.750-764.0	Coil, Solenoid, 12-24V - S
9.802-640.0	Coil, Solenoid, 120V - M/L
9.802-641.0	Coil, Solenoid, 230V - M/L
8.700-794.0	Coil, Solenoid, 12-24V - M/L

Wayne Burner Replacement Part Cross Reference Chart

Material	Material Description	Fuel Pump	Ignitor	Burner Motor	Burner Fan	Coupling
8.756-181.0	BURNER, MSR 3.75 120V 1T 120V S	8.756-290.0	8.700-803.0	8.756-292.0	8.700-728.0	8.700-822.0
8.756-253.0	Burner MSR 3.75 120V 1T7A 120 V S	8.756-290.0	8.700-803.0	8.756-292.0	8.700-728.0	8.700-822.0
8.756-254.0	BURNER, MSR 3.75 230V 1T 230V S	8.700-760.0	8.756-324.0	8.717-830.0	8.700-728.0	8.700-822.0
8.756-413.0	BURNER, EHASR 120V 2T 120V S	8.700-760.0	8.700-802.0	8.756-436.0	8.756-438.0	8.700-776.0
8.756-456.0	BURNER, EHASR 230V 1T 24V S	8.756-437.0	8.756-291.0	8.756-294.0	8.756-677.0	8.700-776.0
8.756-480.0	BURNER, EHASR 12VDC DO 2T 12VDC S	8.756-437.0	9.107-507.0	8.756-716.0	8.756-726.0	8.756-715.0
8.756-655.0	BURNER, MSR 12V 1T 12V S DC	8.756-437.0	9.107-507.0	8.700-739.0	8.756-674.0	8.700-721.0
8.756-681.0	BURNER, EHASR 12VDCDO 1T 12V S	8.756-437.0	9.107-507.0	8.756-716.0	8.756-674.0	8.756-715.0
8.756-703.0	BURNER, EHASR 120V 1T 120V S	8.756-290.0	8.700-802.0	8.756-293.0	8.756-677.0	8.700-776.0
8.756-736.0	BURNER, EHASR 12VDC 1T 12VDC SOL	8.756-437.0	9.107-507.0	8.756-716.0	8.756-730.0	8.756-715.0
8.756-756.0	BURNER, EHASR 12VDCDO 1T 12VDC S	8.756-437.0	9.107-507.0	8.756-716.0	8.756-730.0	8.756-715.0
8.756-890.0	BURNER , EHASR 12VDC DO 2T 12V S	8.756-437.0	9.107-507.0	8.756-716.0	8.756-726.0	8.756-715.0
8.756-921.0	BURNER, EH 1.75 120V 1T 120V S	8.717-814.0	8.700-802.0	8.756-436.0	8.756-438.0	8.700-776.0
8.756-922.0	BURNER, EH 1.75 230V 1T 120V S	8.717-814.0	8.700-802.0	8.756-745.0	8.756-438.0	8.700-776.0
8.754-264.0	BURNER, WAYNE, EH, 12VDC, 10GPM	8.717-814.0	9.107-507.0	8.700-739.0	8.756-856.0	8.756-715.0
8.754-265.0	BURNER, WAYNE, EH, 12VDC 6-8 GPM	8.717-8.14.0	9.107-507.0	8.700-739.0	8.756-856.0	8.756-715.0
8.754-792.0	BURNER, WAYNE, EH, 12VDC, 6GPM	8.717-814.0	9.107-507.0	8.700-739.0	8.756-726.0	8.756-715.0
8.754-793.0	BURNER, WAYNE, EH, 12VDC, 5GPM	8.717-814.0	9.107-507.0	8.700-739.0	8.756-726.0	8.756-715.0

Hotsy's Dirty Dozen

Recommendations for the Top Hotsy Soaps



#1 BREAKTHROUGH!

Hotsy's best all-purpose detergent

Highly concentrated with dilution ratio of 150 to 1. Whether removing grease or cleaning a finely painted automobile, Breakthrough! is the best all around "go to" detergent. Breakthrough's high foaming action attacks dead oxidized paint and can be used in hard and cold water applications.

#2 TRANSPORT VEHICLE WASH

Hotsy's most economical detergent for vehicles

If it has wheels, Transport is the detergent of choice. Autos, buses, motor homes, mobile homes, tractor trailers are just a few applications for this economical liquid detergent. Great when used as a pre-spray for engine compartment cleaning and safe on all painted surfaces, stainless steel, aluminum and glass.

#3 RIPPER 1

Hotsy's best heavy-duty degreaser

Ripper 1 is specially formulated for degreasing heavy equipment and hard to remove road film on tractor trailers, end loaders, excavators and backhoes, yet still safe on painted surfaces. Non-caustic and user-friendly.

#4 HOTSY BROWN

Hotsy's best detergent for oil field cleaning

A degreasing detergent specially formulated for the oil field that also works great on oil soaked or stained surfaces such as, frames and equipment. A non-butyl based product that works good in cold water, Hotsy Brown is a caustic based product and should not be used on fine painted surfaces or magnesium, galvanized or aluminum.

#5 ADVANCED FORMULA ALUMINUM BRIGHTENER

Hotsy's aluminum brightening product

This highly concentrated acid with dilution ratios up to 20 to 1, attacks oxidized aluminum leaving a "like new" look to the surface after the initial application. Not to be used on new aluminum or aluminum that is not oxidized.

#6 FAT CAP GRAFFITI REMOVER BRICK, MASONRY & CONCRETE

Hotsy's easy-to-use liquid graffiti remover

The #1 alternative to sand blasting or painting over unsightly graffiti. Designed for use on exterior brick, masonry and concrete surfaces. Hotsy Fat Cap Graffiti Remover - Brick, Masonry and Concrete cleaner is deep penetrating and fast acting for effective and thorough loosening of spray paint graffiti and easy removal of the graffiti from the surface being treated.

#7 SALT LICK

Hotsy's answer to removing salt and de-icing solution

Salt Lick is formulated to remove salt, calcium chloride and de-icing solution used on winter roads by breaking down the crystal-line structure of ice melt products and prevents them from re-crystallizing so they can be washed away. Salt Lick is a dual-purpose concentrated detergent attacking heavy soils and road film.

#8 CARBOCHLOR

Hotsy's #1 choice for cleaning food preparation areas

A special emulsifying formula with high powered bleach for food processing plants. Excellent on tough odors, stains, dirt, oils and fats left behind on equipment, floors, and walls. NSF recognized for use in Federally Inspected food plants.

#9 CON-B-GONE

Hotsy's choice for removing green concrete from ready-mix trucks and tools

A fast acting acidic product that when applied to ready mix trucks, forms and tools softens dried concrete splatter allowing it to be rinsed away with a hot or cold water pressure washer. Con-B-Gone's foaming formula makes application over large areas quick and easy. A Hotsy Foamer increases dwell time and maximizes end results!

#10 VERDE ALL PURPOSE

#1 environmentally-friendly green product for general purpose cleaning

A unique blend of environmentally preferred chemicals that provide great cleaning capabilities in all water conditions and all water temperatures. Superior foaming and fast-rinsing provide great results while saving money and the environment.

#11 TUBMATE GENERAL PURPOSE

Hotsy's heavy-duty automatic parts washer detergent

A phosphate-free, biodegradable, super-concentrated liquid. Works great with automatic detergent injectors; can be automatically metered into aqueous parts washers. Quick oil release and solvent free. Heavy duty rust and corrosion inhibitor package protects against flash rusting; defoamers reduce foam in your aqueous parts washer.

#12 CITRUS CLEAN

Hotsy's answer to "beefing up" the cleaning action of any Hotsy detergent

This citrus-based detergent additive increases any detergent's cleaning and degreasing power and is a great degreaser in its own right, plus it also enhances rinsing. Contains d-limonene which is a great "natural" degreaser.

HOTSY Detergents

Hotsy offers a complete line of biodegradable pressure washer detergents at cost-effective prices. Each is specially formulated for use with pressure washers. Available in a wide variety of quantities - from five-gallon pails to 55-gallon drums, and even Bulk Packs with up to 200+ gallons of on-site storage. Ask your local Hotsy dealer for more info.



All Purpose Cleaners

Breakthrough!

This highly concentrated detergent is effective for tackling crude oil and caked-on buildup of fifth-wheel grease . . . yet it's gentle enough for fine finishes on cars and to use for general cleaning purposes. Helps restore all types of oxidized paint surfaces.

Part #	Description
8.905-136.0	Breakthrough!, 5 Gallons
8.905-137.0	Breakthrough!, 55 Gallons
	Bulk sizes available - ask for details

Blue Thunder

A popular vehicle cleaner for removing exhaust deposits, road film and bug residue. Excellent for older vehicles with faded finishes; helps restore oxidized paint surfaces of all types. Great for housewashing. Works well in cold water.

Part #	Description
8.905-442.0	Blue Thunder, 5 Gallons
	Bulk sizes available - ask for details

Product 31

Here's an all-purpose vehicle cleaner for a wide range of applications. Use it on over-the-road tractors and trailers, truck fleets, and cars. Powerful yet gentle cleaners attack road film and dirt while protecting painted surfaces. Helps restore all types of oxidized paint surfaces.

Part #	Description
N/A	Product 31 bulk sizes available - ask for details

Super X

This concentrated powder is popular in the agriculture, construction, transportation and food industries. Safe on all surfaces, it's easy to use, low foaming and free rinsing.

Part #	Description
8.904-673.0	Super X, 50 lb Drum
8.904-674.0	Super X, 100 lb Drum
8.904-675.0	Super X, 450 lb Drum

Super XL

Low foaming detergent for reduced rinse time. A highly efficient truck wash detergent designed to be low foaming and very free rinsing. Super XL cleans without the bubbles and foam to drastically reduce rinse time and is a favorite of contract cleaners and truck wash facilities.

Part #	Description
8.904-725.0	Super XL, 5 Gallons
8.904-728.0	Super XL, 55 Gallons
	Bulk sizes available - ask for details

Vehicle Wash Detergents

Transport Vehicle Wash

Economical liquid detergent cleans stainless steel, aluminum, glass and painted surfaces such as cars, trucks, buses, RV's, trailers, mobile homes, tractors, etc. Use as a pre-spray for cleaning engines, whitewall tires, vinyl and metal tops.



Part #	Description
8.904-732.0	Transport, 5 Gallons
8.904-733.0	Transport, 55 Gallons
	Bulk sizes available - ask for details

Carbon-Ate

Especially formulated to clean engine compartments and hard to clean vehicles, road film, white wall tires and carbon (diesel smoke and exhaust). Works great on polished aluminum.

Part #	Description
8.904-896.0	Carbon-Ate, 5 Gallons
8.904-898.0	Carbon-Ate, 55 Gallons
	Bulk sizes available - ask for details

Envy Super Concentrate

A vehicle wash detergent that works well in all water conditions and temperatures. Ultra concentrated, hard water formula, high-foaming, easy rinsing, flows in colder temperatures.

Part #	Description
8.698-077.0	Envy Super Concentrate, Qty 4, 1 Gallon Containers
8.698-078.0	Envy Super Concentrate, 5 Gallons

Fleet Wash

Extremely effective for cleaning stainless steel, aluminum, glass and painted surfaces on cars, trucks, RV's, buses, trailers, mobile homes, tractors etc. Perfect pre-spray for cleaning engines, whitewall tires, vinyl and metal tops. Helps restore all types of oxidized paint surfaces.

Part #	Description
N/A	Fleet Wash bulk sizes available - ask for details

Vehicle Wash Detergents, continued

Hotsy Red

Outstanding cleaning at a low cost. Ideal for heavy duty, automatic and manual vehicle washing applications. Use at the rate of 1 to 2 oz. per 100 gallons of wash water.

Part #	Description
8.904-829.0	Hotsy Red, 50 lb Drum
8.904-830.0	Hotsy Red, 100 lb Drum
	Bulk sizes available - ask for details

Nytro

Truckers and fleet maintenance specialists swear by this heavy duty detergent. It makes diesel smoke stains, road film and gummy grease residue disappear. It's equally effective on floors, walls and windows. Use this powerful cleaner where other detergents and chemicals fail.

Part #	Description
8.904-929.0	Nytro, 5 Gallons
	Bulk sizes available - ask for details

Panel Wash

A highly effective, economical detergent designed for the truck and transportation industry. It contains a small amount of caustic and is effective as a "pre-spray" to attack the final layer of soil that other products might not penetrate.

Part #	Description
N/A	Panel Wash bulk sizes available - ask for details

Power Shine

High foaming detergent with increased dwell time. Specially formulated for washing vertical painted surfaces and removing bug residue, road film and oxidized paint leaving a shiny surface behind. Safe to use on aluminum and works well in cold water.

Part #	Description
8.904-912.0	Power Shine, 5 Gallons
	Bulk sizes available - ask for details

Vehicle Pre-Soak

Used to remove stubborn soils like bugs, tar, oil and grease deposits on vehicles. Apply before washing in order to penetrate and break up soils. The more time allowed to soak, the less scrubbing is required.

Part #	Description
8.698-230.0	Vehicle Pre-Soak, 5 Gallons
8.698-231.0	Vehicle Pre-Soak, 55 Gallons

Rinse Aid

With a dilution ratio of 5000 to 1, this is an extremely economical additive for rinse cycles. Hotsy Rinse Aid prevents spotting on vehicles.

Part #	Description
8.905-609.0	Rinse Aid, 5 Gallons

Vehicle Tire & Rim Cleaner

Fast and easy way to deep clean the black rubber, road film and brake dust soils from your tires and rims. Simply spray, wait and rinse. This product should be used to clean tire and wheels before adding tire dressing. Make tire dressings look better and last longer. Safe to use on all tires. Safe for steel and aluminum wheels, including coated wheels.

Part #	Description
8.698-229.0	Vehicle Tire and Rim Cleaner, 12 x 1-Qt

Degreasers

Ripper I

A highly concentrated, non-caustic cleaner for heavy equipment and trucks. This fast-acting cleaner is especially effective on off-road and grease-clogged equipment and great on hard-to-remove road film on tractor/trailers. Safe to use indoors and on all painted surfaces. Excellent for cleaning shop floors and walls where inside cleaning is necessary.



Part #	Description
8.904-846.0	Ripper I, 5 Gallons
8.904-847.0	Ripper I, 55 Gallons
8.698-092.0	Ripper I, 275 Gallon Tote

Ripper II

The serious big brother to Ripper I. Used when extra degreasing power for heavy equipment is needed. The detergent's superior cleaning action will handle the heavy grease oil and hydraulic oils. Has been used as a pre-paint wash and is not to be used on fine painted surfaces, galvanized, aluminum or magnesium surfaces.

Part #	Description
8.904-850.0	Ripper II, 5 Gallons
8.904-851.0	Ripper II, 55 Gallons
8.698-093.0	Ripper II, 275 Gallon Tote

Degreasers, continued

Ripper III

This heavy-duty degreaser is ideal for use as a hood and vent cleaner and will also strip paint and powder coated surfaces. Also great for cleaning hood and vents at restaurants. DO NOT USE on aluminum, magnesium, galvanized metal or fine painted surfaces. Contains Sodium Hydroxide.

Part #	Description
8.904-839.0	Ripper III, 5 Gallons
8.904-840.0	Ripper III, 5 Gallons

Citrus Clean

This citrus-based detergent additive increases any detergent's cleaning and degreasing power and is a great degreaser in its own right, plus it also enhances rinsing. Citrus Clean contains d-limonene which is a great "natural" degreaser.

Part #	Description
8.904-985.0	Citrus Clean, 5 Gallons
8.904-986.0	Citrus Clean, 55 Gallons

Oil Field & Heavy Equipment Cleaners

Hotsy Brown

This versatile, extra-strong detergent is caustic based for fast and thorough cleaning. Hotsy Brown is a non-butyl product that is particularly effective on carbon based deposits such as road film and exhaust stains, as well as dirt and grease. Not recommended for use on fine finishes, aluminum, galvanized metal or magnesium.



Part #	Description
8.915-455.0	Hotsy Brown, 5 Gallons
8.915-453.0	Hotsy Brown, 55 Gallons

Bulk sizes available - ask for details

Hotsy Orange

Hotsy's low pH degreaser. This surfactant based non-caustic detergent was developed for people in the oil field that needed good degreasing and cleaning but also needed to be user friendly and have a pH of below 10.5. Orange is safe on painted surfaces and is very effective on carbon based deposits; road film and truck exhaust stains.

Part #	Description
8.698-066.0	Hotsy Orange, 275 Gallons

Other sizes available - ask for details

Aluminum & Stainless Steel Cleaners

Advanced Formula Aluminum Brightener

An extra-strength, acid-based, aluminum cleaner and brightener designed for non-polished aluminum tanks and trailers, aluminum wheels and for preparing aluminum surfaces for painting. This easy-to-apply formula restores aluminum and makes it look like new in just one application. Do NOT use on glass, polished aluminum or anodized aluminum. Contains no phosphates.



Part #	Description
8.698-227.0	Adv. Formula Aluminum Brightener, 5 Gallons
8.698-228.0	Adv. Formula Aluminum Brightener, 55 Gallons

Polished Aluminum & Stainless Steel Cleaner

This non-etching specialty cleaner contains a concentrated blend of surfactants and glycol ethers to quickly peel and remove dirt, grease, oil, road film, diesel smoke and welding smut.

Part #	Description
8.904-749.0	Polished Aluminum & Stainless Steel Cleaner, 5 Gallons
8.904-751.0	Polished Aluminum & Stainless Steel Cleaner, 55 Gallons

Yellow Fever

Yellow Fever is a powerful acidic cleaner and aluminum brightener to clean and restore stained aluminum surfaces, without dulling bright aluminum finishes. Yellow Fever is effective in removing diesel smoke, grease, carbon, oils and resins. Removes hard-water scale. Effective in removing mineral efflorescence from brick, masonry and concrete. AVOID CONTACT WITH GLASS OR ANODIZED ALUMINUM.

Part #	Description
8.698-061.0	Yellow Fever, 5 Gallons
8.698-062.0	Yellow Fever, 55 Gallons

FAC - Foaming Acid Concentrate Cleaner

FAC is a heavy duty, high foaming acid cleaner. When used through a foaming device, air or airless, the product produces a thick, light foam that will cling to vertical surfaces allowing significant dwell time for the acid to dissolve milk stone and mineral build up on surfaces. Safe on Stainless Steel. This concentrated formula can dissolve milkstone up to 4 times faster than competitive products at the same dilution. Save time or dilute to lower cost of use. Save space and freight with this concentrated formula.

Part #	Description
8.698-128.0	FAC, 15 Gallons
8.698-129.0	FAC, 55 Gallons

Environmentally Friendly

Verde All Purpose

A unique blend of environmentally preferred chemicals that provide great cleaning capabilities in all water conditions and all water temperatures. Superior foaming and fast-rinsing provide great results while saving money and the environment.



Enviro-Clean

This phosphate-free detergent is excellent for communities where phosphates are prohibited from entering municipal wastewater treatment facilities. It's safe for all kinds of cleaning, yet has the cleaning power of highly concentrated degreasers. It is great on polished aluminum.

Enviro Gard 2

A quick-release detergent formulated for use with filtration-type or gray water recycle systems. This phosphate-free, biodegradable liquid releases oils and greases rapidly for maximum separation. Low solid content reduces build-up, allowing more cycles between discharge. Non-emulsifying.

Part #	Description
8.698-079.0	Verde All Purpose, 5 Gallons
8.698-080.0	Verde All Purpose, 55 Gallons

Part #	Description
8.904-927.0	Enviro-Clean, 5 Gallons
	Bulk sizes available - ask for details

Part #	Description
8.905-124.0	Enviro Gard 2, 55 Gallons
	Bulk sizes available - ask for details

Transportation Specialty Cleaners

Salt Lick

Salt Lick is formulated to remove salt, calcium chloride and de-icing solution used on winter roads by breaking down the crystalline structure of ice melt products and prevents them from re-crystallizing so they can be washed away. A dual-purpose concentrated detergent attacking heavy soils and road film.



400 Wax

Added to a final rinse, this long-lasting, liquid wax creates a durable finish that improves a vehicle's appearance and keeps dirt from adhering to the surface. It gives added protection against salt, air pollution and acid rain. With a dilution ration of 12000 to 1, this is a highly economical wax.

Aero One

Approved for aircraft use, this non-toxic compound has met rigorous standards set by the aerospace industry (Aerospace Specification AMS-1526). High concentrations of corrosion inhibitors fight effects of salt, air pollution and acid rain. Meets Aerospace Materials Specification AMS-1526C Cleaner for Aircraft Exterior Surfaces, Water-Miscible, Pressure-Spraying Type.

Carbon-Ate Plus

A special wax is added to Carbon-Ate Plus to provide a durable, attractive finish that keeps dirt from adhering to surfaces and protects them against salt, air pollution and acid rain. Easy to rinse and it reduces water spotting. It works great on polished aluminum.

Power Shine Plus

A special wax is added to provide a durable, attractive finish that keeps dirt from adhering to surfaces and protects them against salt, air pollution and acid rain. Helps restore oxidized paint surfaces of all types. Easy to rinse; reduced water spotting. It is great on polished aluminum.

Part #	Description
8.698-081.0	Salt Lick, 5 Gallons
8.698-082.0	Salt Lick, 55 Gallons

Part #	Description
8.905-531.0	400 Wax, 5 Gallons

Part #	Description
8.905-634.0	Aero One, 5 Gallons
8.905-636.0	Aero One, 5 Gallons

Part #	Description
8.904-832.0	Carbon-Ate Plus, 5 Gallons
	Bulk sizes available - ask for details

Part #	Description
8.904-817.0	Power Shine Plus, 5 Gallons
	Bulk sizes available - ask for details

Institution & Food Preparation

Carbochlor

A special emulsifying formula with high powered bleach for food processing plants. Excellent on tough odors, stains, dirt, oils and fats left behind on equipment, floors, and walls. Chlorinated for extra punch. NSF Registered for use in federally inspected food plants.



Part #	Description
8.904-979.0	Carbochlor, 5 Gallons
8.904-980.0	Carbochlor, 55 Gallons
Bulk sizes available - ask for details	

Miracle Wizz

An unsurpassed liquid for removing baked-on carbon found in food preparation, bakeries, restaurants, food processing plants etc. It is also great for engine degreasing and graffiti removal.

Part #	Description
8.904-924.0	Miracle Wizz, 5 Gallons
Bulk sizes available - ask for details	

Specialty Cleaners

Con-B-Gone

Con-B-Gone is a fast acting acidic product that when applied to ready mix trucks, forms and tools softens dried concrete splatter allowing it to be rinsed away with a hot or cold water pressure washer. Con-B-Gone's foaming formula makes application over large areas quick and easy. A Hotsy Foamer increases dwell time and maximizes end-results!



Part #	Description
8.698-083.0	Con-B-Gone, 5 Gallons
8.698-084.0	Con-B-Gone, 55 Gallons
8.698-085.0	Con-B-Gone, 275 Gallons

Coil Conditioner

A special conditioner for removing hard water deposits and scale from the internal surface of heating coils.

Part #	Description
8.904-764.0	Coil Conditioner, 2 lb Containers, Qty 12

Liquid Foamer

When combined with most detergents, it creates mountains of suds and increases dwell time to loosen dirt, grease and oil. Designed for use with foam generators and revolving brushes.

Part #	Description
8.905-527.0	Liquid Foamer, 5 Gallons

Phosphatizer No. 2

A complete and economical detergent and phosphatizing system for one-step cleaning and phosphatizing of iron and steel parts. Hotsy Cleaner / Phosphatizer No. 2 can be used at temperatures ranging from 120°F to 180°F. Equally effective in spray, dip and wipe-on applications. A quality product with 20 years of successful history in the industry.

Part #	Description
8.904-977.0	Phosphatizer No. 2, 5 Gallons
8.904-978.0	Phosphatizer No. 2, 55 Gallons
Bulk sizes available - ask for details	

Graffiti Remover

Fat Cap Graffiti Remover - Brick, Masonry & Concrete

An easy-to-use liquid graffiti remover designed for use on exterior brick, masonry and concrete surfaces. Hotsy Fat Cap Graffiti Remover - Brick, Masonry and Concrete cleaner is deep penetrating and fast acting for effective and thorough loosening of spray paint graffiti and easy removal of the graffiti from the surface being treated. This is the strongest product in the Hotsy Fat Cap Remover family of products.



Part #	Description
8.698-028.0	Fat Cap Graffiti Remover, 1 Quart, Qty 12
8.698-027.0	Fat Cap Graffiti Remover, 1 Gallon, Qty 4

Parts Washers

Tubmate General Purpose Detergent

A phosphate-free, biodegradable, super-concentrated liquid. Works great with automatic detergent injectors; can be automatically metered into aqueous parts washers. Quick oil release and solvent free. Heavy duty rust and corrosion inhibitor package protects against flash rusting; defoamers reduce foam in your aqueous parts washer.



Part #	Description
8.905-144.0	Tubmate General Purpose, 5 Gallons
8.905-150.0	Tubmate General Purpose, 55 Gallons

Bulk sizes available - ask for details

Hotsy Defoamer

This biodegradable defoamer is added to parts-washer cleaning solutions to reduce foam buildup. Hotsy Defoamer does not interfere with the detergent's normal cleaning ability.

Part #	Description
8.904-652.0	Hotsy Defoamer, 1 Gallon Containers, Qty 4

Tubmate Iron & Steel Cleaner

A heavy-duty liquid detergent, perfect for truckers, manufacturers, food processors, bakeries and other applications requiring the removal of heavy grease, baked-on carbon, loose paint and coatings. Rust and corrosion inhibitors and heavy defoamer package. Not an EPA hazardous waste at a pH of less than 12.5.

Part #	Description
8.905-087.0	Tubmate Iron & Steel Cleaner, 5 Gallons

Floor Care

Floor Wash

Designed for use as a floor cleaner for food, automotive and manufacturing industries. It can be used with hot or cold water and is formulated with a color indicator for control of concentration and strength, and to insure uniform coverage and rinsing.

Part #	Description
8.749-836.0	Floor Wash, 40 lb Pail
8.749-837.0	Floor Wash, 100 lb Drum

Hotsy "99"

A highly concentrated formulation of non-fuming inhibited phosphoric acid and surfactants that remove concrete, welding smut, hard-water scale, rust, mortar, and diesel smoke. It is ideal for cleaning and descaling concrete trucks, metal surfaces, equipment, bricks and glass. DO NOT USE on polished aluminum.

Part #	Description
8.904-842.0	Hotsy "99", 5 Gallons
8.904-843.0	Hotsy "99", 55 Gallons

Shop Floor Cleaner

Specially designed to break up and lift petroleum based, greasy soils commonly found in equipment repair shops. Designed for machine use. Won't harm epoxy finishes, floor paint when used as directed. Phosphate-free. Effective on any floor surface. Use 1 fluid ounce of product per gallon for routine cleaning. For heavier soil accumulations, use up to 2 ounces per gallon.

Part #	Description
8.698-131.0	Shop Floor Cleaner, 5 Gallons
8.698-132.0	Shop Floor Cleaner, 55 Gallons
8.698-133.0	Shop Floor Cleaner, 275 Gallons

Animal Hygiene & Bio-Security

LFB Copper - Liquid Foot Bath With Copper

Dosage: 25 oz. per 50 gallons of water. Change bath every 400-500 cows or if excessively contaminated by mud and manure. See label for complete instructions.

Part #	Description
8.698-115.0	LFB Copper, 15 Gallons
8.698-116.0	LFB Copper, 55 Gallons

LFB Clear - Liquid Foot Bath

Dosage: 32 oz. per 50 gallons of water plus 10 lbs. of Copper Sulfate. Change Bath every 400-500 Cows or if excessively contaminated by mud and manure. See label for complete instructions.

Part #	Description
8.698-113.0	LFB Clear, 15 Gallons
8.698-114.0	LFB Clear, 55 Gallons

Animal Hygiene & Bio-Security, continued

OSFB - One Step Foot Bath

Add 128 ounces of Hotsy OSFB per 50 gallons of water. NOTE: We have seen good results by using less as a maintenance program. Usage may vary due to organic load, water hardness, wet/humid weather or an extreme breakout of warts or similar condition.

Part #	Description
8.642-665.0	OSFB, 5 Gallons
8.642-666.0	OSFB, 275 Gallons

OPD - Oxy Pre Teat Dip

A teat dip product which is ready to use. Spray, dip or foam application. Also available in a concentrate formula.

Part #	Description
8.698-118.0	OPD, 55 Gallons
8.698-119.0	OPD, 275 Gallons
8.698-195.0	OPD Concentrate, 55 Gallons
8.698-215.0	OPD Concentrate, 275 Gallons

TD 44 Conditioning Post Teat Dip

A teat dip product which is ready to use. Spray, dip or foam application. Also available in a concentrate formula.

Part #	Description
8.698-120.0	TD44, 55 Gallons
8.698-121.0	TD44, 275 Gallons
8.698-196.0	TD44 Concentrate, 55 Gallons
8.698-216.0	TD44 Concentrate, 275 Gallons

TD Blue - Post Teat Dip

A teat dip product which is ready to use. Spray, dip or foam application.

Part #	Description
8.698-122.0	TD Blue, 55 Gallons
8.698-123.0	TD Blue, 275 Gallons
8.698-217.0	TD Blue Concentrate, 55 Gallons
8.698-218.0	TD Blue Concentrate, 275 Gallons

PPD - Pre and Post Dip

Easy to mix: 1 drum of concentrate makes one 275 gallon tote. Spray, dip or foam application. See label for complete directions.

Part #	Description
8.698-240.0	PPD Ready to Use, 275 Gallons
8.698-241.0	PPD Concentrate, 55 Gallons

DCS - Dry Cow Sealant

Use a dedicated container or cup to apply product. Do not save or pour unused product back into original container.

Part #	Description
8.698-124.0	DCS, 1 Quart Containers, Qty 6

NDT - Naval Dip Treatment

Use a dedicated container or cup to apply product. Do not save or pour unused product back into original container.

Part #	Description
8.698-125.0	NDT, 1 Gallon Containers, Qty 4

THS - Topical Hoof Spray

Spray directly on wart or infected area.

Part #	Description
8.698-126.0	THS, 1 Quart Containers, Qty 6

MTP - Manure Treatment Product - Dairy

Charging the lagoon system requires four bulk applications based on the number of dairy cows on the property. After that, 1oz per day per cow is all that is required to keep your lagoons healthy and odor free.

Part #	Description
8.698-110.0	MTP, 5 Gallons
8.698-111.0	MTP, 275 Gallons

HMTP - Hog Manure Treatment Product

Apply directly to the liquid portion of the swine-producing facility's manure pit in several location. If a solid crust is present, use an injection pipe (such as a PVC pipe) to apply product toward bottom of the pit.

Part #	Description
8.698-219.0	HMTP, 5 Gallons
8.698-220.0	HMTP, 275 Gallons

Animal Hygiene & Bio-Security, continued

Vital Oxide - Cleaner and Disinfectant

Apply directly to the liquid portion of the swine-producing facility's manure pit in several location. If a solid crust is present, use an injection pipe (such as a PVC pipe) to apply product toward bottom of the pit.

Part #	Description
8.698-112.0	Viatl Oxide, 55 Gallons (US Only)
8.756-449.0	Viatl Oxide, 55 Gallons (Canada Only)
8.639-558.0	Vital Oxide, 1 Gallon Container, Qty 4 (US Only)
8.639-559.0	Vital Oxide, 1 Gallon Container, Qty 4 (Canada Only)
8.639-560.0	Vital Oxide, 1 Quart Container, Qty 6 (US Only)

1-Pack Laundry Portion Control Packs

One pack per 50 lbs. of laundry. Place packet into detergent reservoir or place directly into wash wheel.

Part #	Description
8.698-117.0	1-Pack Laundry Portion Control Packs, 550 Count

Chemical Dispensing Equipment



Product Mixing Stations

Ball valve chemical proportioner for accurately diluting a chemical concentrate to the required ratio and for filling any sized container with diluted, ready-to-use chemical solution. Venturi injection system uses city water pressure to draw and blend chemical concentrate into the water stream to create an accurately diluted solution. Ball valve activation allows for hands-free dispensing.

PART NO.	DESCRIPTION
8.755-141.0	Single Product Mix - Low Flow
8.755-142.0	Single Product Mix - High Flow
8.755-143.0	Dual Product Mix - Low Flow
8.755-144.0	Dual Product Mix - High Flow



Internal Tank Foamers

Tank Foamer is a low-volume foam applicator with an all stainless steel cart assembly for applying ready-to-use foaming chemicals. Connect compressed air to pressurize the 316L stainless steel tank and to inject air into the solution to greatly increase volume and coverage ability.

PART NO.	DESCRIPTION
8.755-145.0	5-Gallon Tank Foamer
8.755-146.0	16-Gallon Tank Foamer



Poly Tank 2-Wheeled Foamer

The Portable 2-Wheel 20 Gallon LF Foamer is a "low volume" foam applicator for projecting ready-to-use foaming chemicals on to any surface up close or at distances up to 9 feet. Features stainless steel cart.

PART NO.	DESCRIPTION
8.755-147.0	20-Gallon Poly Tank Foamer



Ultimate Foamer With Gauges

A medium volume foam applicator for projecting foaming chemicals on to any surface up close or at a distance. This venturi injection system uses city water pressure to draw and blend chemical concentrate into the water stream to create an accurately diluted solution.

PART NO.	DESCRIPTION
8.755-149.0	Ultimate Foamer



HV Foamer With Gauges

The HV Foamer is a high volume foam applicator for projecting foaming chemicals on to any large surface. Foam is projected through a discharge hose and fan nozzle at distances up to 15 feet.

PART NO.	DESCRIPTION
8.755-150.0	HV Foamer

Chemical Dispensing Equipment, continued



32 oz. Compact Airless Foamer

Medium volume hose-end foam gun for diluting and applying foaming chemicals to any surface. Uses standard city water pressure to draw chemical concentrate from the attached bottle and blend it into the water stream. The accurately diluted solution creates a clinging, wet foam which is then projected on to any surface up close or at distances up to 12 feet.

PART NO.	DESCRIPTION
8.755-151.0	Compact Airless Foamer

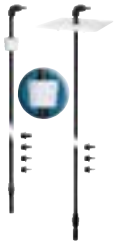

Drum Sticks and Tote Sticks

Chemical pick-up assembly to draw chemical solution directly from a drum or tote. Comes complete with a Hastelloy chemical strainer, polypropylene chemical check valve and a selection of polypropylene hose barbs to connect to the most common sizes of hose or tube.

PART NO.	DESCRIPTION
8.755-138.0	Tote Sticks - 54"
8.755-139.0	Drum Stick Pick Up Assembly - 33"



Hand Hygiene Spray Dispensers

Heavy-duty, stainless steel hand sanitizer or soap dispenser; when foot pedal is pressed, the system draws a set amount of ready-to-use chemical and dispenses it directly into the users hand. No electricity or batteries are required.

optional one gallon jug rack

PART NO.	DESCRIPTION
8.755-136.0	Spray Dispenser, Wall Mount
8.755-137.0	Spray Dispenser, Floor Mount

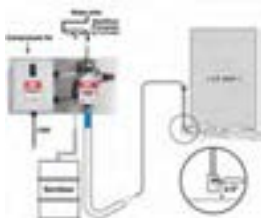

Timed Entryway Foam Sanitizer

An automated foam applicator for projecting sanitizing chemicals on to floors of 3' wide walk doors to prevent cross contamination. When activated, this venturi injection system uses city water pressure to draw and blend chemical concentrate into the water stream to create an accurately diluted solution.

PART NO.	DESCRIPTION
8.755-140.0	Timed Entry Way - 3' door



Uni-Body Combo Demo Foamer

A combination foam / spray applicator for demonstrating foaming or non-foaming chemicals being applied to any surface. Use the foam wand and nozzle for rich, clinging foam, the airless foam wand to demonstrate without compressed air, or use the spray nozzle to apply chemicals as a fan pattern spray. *Special order.

PART NO.	DESCRIPTION
8.755-152.0	Uni-Body Combo Foamer



City Water Pressure / Flow Test Kit

Connects to a standard male garden hose fitting. Provides quick confirmation of available water pressure and flow rate. Can also be mounted in-line with installed equipment to determine operational water pressure. *Special order.

PART NO.	DESCRIPTION
8.755-148.0	Water Flow Test Kit

Legacy "Best" Spray Gun



Ergonomically designed to be the most comfortable gun on the market.



- PSI: 5000
- GPM: 12
- Temperature: 300°F
- 3/8" FPT inlet x 1/4" FPT outlet
- Weight: 21 oz
- Ideal for commercial cleaning and long work time applications

Part No.	Description
8.751-213.0	"Best" Spray Gun
8.701-673.0	Unitized Valve Kit

Legacy "Industrial" Spray Gun



Featuring a comfortable grip to reduce user fatigue.



- PSI: 5000
- GPM: 10.4
- Temperature: 300°F
- 3/8" FPT inlet x 1/4" FPT outlet
- Weight: 19.84 oz
- Ideal for various industrial cleaning applications

Part No.	Description
8.751-214.0	"Industrial" Spray Gun
8.751-119.0	Valve Kit

PA Linear Gun

Ergonomic design minimizes fatigue for operator



- PSI: 4500
- GPM: 10.5
- Temperature: 320°F
- 3/8" FPT inlet x 1/4" FPT outlet
- Weight: 19.2 oz

Part No.	Description
8.752-080.0	PA Linear Gun
9.801-398.0	PA Linear Gun Repair Kit

AP Trigger Gun



- PSI: 4500
- GPM: 8
- Temperature: 320°F
- 3/8" FPT inlet x 1/4" FPT outlet
- Weight: 16.08 oz

Part No.	Old No	Description
8.754-907.0	353030	MV925

M407 Trigger Gun



- PSI: 4000
- GPM: 7
- Temperature: 250°F
- 3/8" FPT inlet x 1/4" FPT outlet
- Weight: 13.4 oz

Part No.	Description
8.750-247.0	M407 Trigger Gun
8.750-456.0	M407 Gun Repair Kit

J.E. Adams Gun



- PSI: 4500
- GPM: 12
- Temperature: 300°F
- 3/8" FPT inlet x 1/4" FPT outlet

Part No.	Description
8.710-391.0	J.A. Trigger Gun

Giant Trigger Guns



The original "heavy-weight".



- PSI: 5000
- GPM: 10
- Temperature: 300°F
- 3/8" FPT inlet x 1/4" FPT outlet
- Weight: 29.28 oz

Part No.	Old No	Description
8.710-394.0	352290	21290C – Brass Outlet
8.710-392.0	352250	21250B – Stainless-Steel Outlet
8.722-172.0	G021227	Repair Kit

GUNS & LANCES

Suttner Trigger Guns



- PSI: 1800
- GPM: 21
- Temperature: 300°F
- 3/8" FPT inlet x 1/4" FPT outlet
- Weight: 1.30 lb

ST-2620

Part No	Old No	Description
8.723-666.0	87236660	ST-2620
8.723-667.0	87236670	ST-2720 Stainless-steel

Excellent for truck and fleet washing applications.



- PSI: 2000
- GPM: 8
- Temperature: 320°F
- 3/8" FPT inlet x 1/4" FPT outlet
- Weight: .82 lb

ST-810 POM

Part No	Old No	Description
8.710-372.0	352210P	ST-810 Gun



- PSI: 5000
- GPM: 12
- Temperature: 300°F
- 3/8" FPT inlet x 1/4" FPT outlet
- Weight: 21 oz

ST-2605

Part No	Old No	Description
8.710-376.0	352219	ST-2605
8.701-673.0	089850	Unitized Valve

Extreme durability with easy pull trigger.



- PSI: 5000
- GPM: 12
- Temperature: 300°F
- 3/8" FPT inlet x 1/4" FPT outlet
- Weight: 21 oz

ST-2305

Part No	Old No	Description
8.710-386.0	352238	ST-2305
8.701-673.0	089850	Unitized Valve
8.701-674.0	089851	Unitized Weep Valve

Extreme durability with easy pull trigger.



- PSI: 5000
- GPM: 12
- Temperature: 300°F
- 3/8" FPT inlet x 1/4" FPT outlet
- Weight: 20.8 oz
- Ceramic ball in valve for higher chemical resistance
- Easy pull trigger

ST-2315

Part No	Description
9.106-073.0	ST-2315

Suttner Trigger Guns



15° offset angle thru gun for easier overhead use. The handle style for "Big Hands".



- PSI: 5000
- GPM: 12
- Temperature: 300°F
- 3/8" FPT inlet x 1/4" FPT outlet
- Weight: 26 oz

ST-2000

Part No	Old No	Description
8.710-388.0	352240	ST-2000
8.701-663.0	089614	Unitized Valve – 4000 PSI
8.751-119.0		Unitized Valve – 5000 PSI
8.701-665.0	089631	Unitized Weep Valve

The perennial favorite for general pressure washer applications.



- PSI: 5000
- GPM: 10.4
- Temperature: 300°F
- 3/8" FPT inlet x 1/4" FPT outlet
- Weight: 20.5 oz

ST-1500

Part No	Old No	Description
8.710-384.0	352235	ST-1500
8.710-385.0	352236	ST-1500 w/ Weep
8.701-663.0	089614	Unitized Valve - 4000 PSI
8.751-119.0		Unitized Valve - 5000 PSI
8.701-665.0	089631	Unitized Weep Valve

Relax action design, stainless-steel gun.



- PSI: 5000
- GPM: 12
- Temperature: 300°F
- 3/8" FPT inlet x 1/4" FPT outlet
- Weight: 21 oz

ST-2700

Part No	Old No	Description
8.710-389.0	352243	ST-2700
8.701-658.0	089070	Unitized Valve

Ceramic Unitized Ball Valve



- Ceramic ball
- Highly resistant against nearly all soaps and acids
- Fits in ST-2300, 2305, 2605, 2700 spray guns as a repair kit

Part No	Description
8.749-907.0	Ceramic Unitized Ball Valve

PA Trigger Gun



- PSI: 3200
- GPM: 8
- Temperature: 320°F
- 3/8" FPT inlet x 1/4" FPT outlet
- Weight: 10 oz



Part No	Old No	Description
8.710-440.0	353207	RL20
8.704-180.0	109993	Repair Kit



- PSI: 5000
- GPM: 10.5
- Temperature: 300°F
- 3/8" FPT inlet x 1/4" FPT outlet
- Weight: 26 oz



Part No	Old No	Description
8.710-377.0	352221	RL30-YG5000
8.704-616.0	111976	Repair Kit



- PSI: 5000
- GPM: 10.5
- Temperature: 300°F
- 3/8" FPT inlet x 1/4" FPT outlet
- Weight: 27.5 oz

Vega 5000

Part No	Old No	Description
8.710-378.0	352222-5	Vega 5000
8.704-232.0	110550	Valve Kit Vega
8.704-615.0	111950	Repair Kit

Easy pull and easy to hold with matching blue lance.



- PSI: 5650
- GPM: 8
- Temperature: 320°F
- 3/8" FPT inlet x 1/4" BSP outlet
- Weight: 23.3 oz
- Blue vent grip, stainless-steel lance has 1/4" BSP threads

RL-56 Gun

40" Stainless Steel Blue Grip Lance



Part No	Old No	Description
9.802-227.0		RL-56 Blue Gun and Wand (does not come with nozzle protector)
8.710-446.0	353250	RL-56 Blue Gun
8.710-645.0	368440PB	40" Stainless-Steel Lance w/ blue vent grip (comes with nozzle protector)
8.704-610.0	111814	Repair Kit – RL-55

Suttner Trigger Gun



15° offset angle thru gun for easier overhead use.



- PSI: 4000
- GPM: 12
- Temperature: 300°F
- 3/8" FPT inlet x 1/4" FPT outlet
- Weight: 23 oz

ST-601

Part No	Old No	Description
8.710-370.0	352201	ST-601
8.701-663.0	089614	Unitized Valve – 4000 PSI
8.751-119.0		Unitized Valve – 5000 PSI

Mecline AL 35 Gun



Easy pull, easy hold!



- PSI: 5000
- GPM: 8
- Temperature: 302°F
- 3/8" FPT inlet x 1/4" FPT outlet
- Weight: 20 oz

Part No	Old No	Description
8.720-563.0	AL016650016	Repair Kit

Big Guns



- PSI: 3200
- GPM: 53
- Temperature: 320°F
- 3/4" F inlet / 1/2" outlet
- Weight: 47.5 oz

Model RL204



- PSI: 7250
- GPM: 21
- Temperature: 210°F
- 1/2" Stainless-steel FPT inlet/outlet
- Weight: 60.3 oz

Model RL84
"Big Black Gun"

Part No	Old No	Description
8.740-165.0		Model RL204
8.749-327.0		Repair Kit – Model RL204
8.704-136.0	109775	Repair Kit – Model 100
8.704-612.0	111900	Repair Kit – Model 160
8.710-445.0	353246	Model RL84
8.750-459.0		Repair Kit for RL84

GUNS & LANCES

MV Hobby Wash Gun

Excellent light-duty gun.



- PSI: 1850
- GPM: 5
- Temperature: 180°F
- 1/4" M inlet x 1/4" F outlet
- Weight: 8.4 oz

Hobby Wash Gun

Part No	Old No	Description
8.710-419.0	353040	Hobby Wash Gun

NOTE: See page 52 for Hobby Unit parts

AP1000 Open Gun

Durable glass reinforced handle



- PSI: 4000
- GPM: 12
- Temperature: 300°F
- 3/8" FPT inlet x 1/4" FPT outlet
- Tubular flow-thru internals for high pressure and efficiency
- Weight: 16.7 oz

AP-1000 Open Gun

Part No	Old No	Description
8.710-396.0	352600	Legacy AP1000 Open Gun

Open Guns

Just plain comfortable!



- PSI: 4060
- GPM: 8
- Temperature: 300°F
- 3/8" FPT inlet x 1/4" FPT outlet
- Weight: 12.3 oz

MV925 Open Gun

Part No	Description
8.754-988.0	MV925 without trigger

ST-1500H Open Gun



- PSI: 5000
- GPM: 10.4
- Temperature: 300°F
- 3/8" FPT inlet x 1/4" FPT outlet
- Weight: 20.5 oz
- Flow through design for less down time

ST-1500

Part No	Old No	Description
8.710-383.0		ST-1500 Open Gun

Flow-Thru Gun



"Full" Grip

- Pistol-grip gun handle
- Tough polyurethane insulation
- Cushion grip
- Full grip or slim line handle

Gun Handle Only

Part No	Old No	Description
8.710-400.0	352606	Full Black Grip 3/8" FPT x 1/4" FPT
Gun Handle w/ 18" Lance		
8.710-403.0	352614	Slim Red Grip 1/4" M x 1/4" F
8.710-404.0	352616	Full Red Grip 3/8" F x 1/4" M

AP Dump Guns



Water continues to run through the tube even when trigger gun is closed.



AP Single Barrel Dump Gun

- PSI: 3000
- GPM: 10.5
- Temperature: 140°F
- 3/8" FPT inlet x 1/8" FPT outlet

Part No	Old No	Description
8.710-405.0	352810	Dump Gun 16" Lance
8.710-406.0	352812	Dump Gun 40" Lance
8.704-169.0	109905	Repair Kit

Dump Gun

Industrial duty dual-barrel.



Dual Barrel Dump Gun

- PSI: 3000
- GPM: 10
- Temperature: 200°F
- 3/8" FPT inlet x 1/4" FPT outlet

Part No	Old No	Description
8.710-408.0	352820	Dump Gun w/ 36" Barrel
8.700-311.0	075296	Repair Kits

Legacy Superlite Stainless-Steel Dual Lance

Superlite stainless-steel with nozzle guard.



Dual Lance w/ Nozzle Guard

- PSI: 4000
- Temperature: 200°F
- Side handle / valve actuator
- Viton seal
- Forged brass valve body
- 1/4" MPT inlet
- 1/8" stainless-steel outlet tubing

Part No	Old No	Description
8.710-618.0	368160	36" - 37.8 oz
8.710-620.0	368165	72" - 56.0 oz
8.900-781.0	109490	Seal Kit

Legacy Square Molded Grip Lances



Legacy

- PSI: 5250
- Temperature: 300°F
- 1/4" male inlet and outlet
- High-quality chrome-plate finish
- Solid molded polymer construction handle with hollow-rib grip for increased heat dissipation

Part No	Description
8.752-898.0	Lance, Molded, 12"
8.752-899.0	Lance, Molded, 20"
8.752-900.0	Lance, Molded, 24"
8.752-901.0	Lance, Molded, 28"
8.752-902.0	Lance, Molded, 36"
8.752-903.0	Lance, Molded, 48"
8.752-904.0	Lance, Molded, 60"
8.752-905.0	Lance, Molded, 79"

Legacy Oval Molded Grip Lances

Featuring a comfortable grip to reduce user fatigue. Legacy



- PSI: 5250
- Temperature: 300°F
- 1/4" male inlet and outlet
- 4:1 safety factor
- Stainless-steel or high-quality chrome-plate finish
- Solid molded polymer construction handle with hollow rib grip for increased heat dissipation

Part No	Description
Stainless-steel	
8.752-882.0	Lance, Molded, 12"
8.752-883.0	Lance, Molded, 20"
8.752-884.0	Lance, Molded, 24"
8.752-885.0	Lance, Molded, 28"
8.752-886.0	Lance, Molded, 36"
8.752-887.0	Lance, Molded, 48"
8.752-888.0	Lance, Molded, 60"
8.752-889.0	Lance, Molded, 79"
8.752-890.0	Lance, Molded, 12"
8.752-891.0	Lance, Molded, 20"
8.752-892.0	Lance, Molded, 24"
8.752-893.0	Lance, Molded, 28"
8.752-894.0	Lance, Molded, 36"
8.752-906.0	Lance, Molded, 36", with handle
8.752-895.0	Lance, Molded, 48"
8.752-907.0	Lance, Molded, 48", with handle
8.752-896.0	Lance, Molded, 60"
8.752-897.0	Lance, Molded, 79"

Dual Lances



Interpump Dual Lance



- PSI: 3000
- GPM: 10
- Temperature: 220°F
- Excellent for downstream injector
- Zinc-plated for chemical resistance
- Brass and stainless-steel valve w/ Viton seals
- Side handle valve adjustment
- Non-deluxe outlet 1/4" FPT

Part No	Old No	Description
8.710-612.0	368150	36" Standard
8.710-621.0	368172	72" Extended
8.904-277.0	368151X	36" Deluxe Standard
8.904-281.0	368173X	72" Deluxe Extended
8.900-135.0	084072X	Valve Repair Kit

Dual Lances



Premium lance with stainless-steel inserted seat.

AL Premium Dual Lance



- PSI: 3600
- GPM: 10.5
- Temperature: 302°F
- 1/4" tubing
- Vented grip
- 1/4" male inlet-female outlet

AL Basic Dual Lance



- PSI: 3600
- GPM: 10.5
- Temperature: 302°F
- 1/4" male inlet-female outlet
- 1/8" zinc-plated tubes
- Square-molded grip inlet

Part No	Old No	Description
8.710-722.0	368925	Stainless-steel Pipe 1/8" nozzles
9.803-267.0	AL8355VPKIT	Repair Kit
8.710-724.0	368927	Basic Dual Lance 1/4" nozzles
8.720-548.0	AL004650300	Repair Kit
8.904-360.0*	368926X	AL Premium Deluxe w/ Quick Coupler and Soap Nozzle



Includes hardened-steel QC inlet plug, 1/8" 40 x 65° soap nozzle and top-quality quick coupler.

See lances with deluxe noted above.

GUNS & LANCES

Suttner Dual Lances



ST-54 w/ Side Handle

ST-53 w/ Knob

- GPM: 10
- Temperature: 300°F
- Zinc/chromate finish
- 38" total length
- Molded grip
- High-pressure, thin-wall tubing
- Weight: 42 oz

Part No	Old No	Description
8.710-613.0	368153	ST-53 w/ Knob (4000 PSI)
8.710-614.0	368154	ST-54 w/ Side Handle (4500 PSI)
8.701-594.0	086884	Repair Kit (ST-53)
8.900-153.0	086883X	Clamp Kit (ST-53/54)
8.701-602.0	086907	Repair Kit (ST-54)

Dual Trigger Lance

Unique Design – Go from high- to low-pressure (rinse-to-soap) with a pull of the trigger. Use with separate trigger gun or as an open gun, and still change from high to low.



- PSI: 3600
- GPM: 12
- Temperature: 300°F
- Zinc-plated steel tubes
- Stainless-steel seat
- Includes nozzle protector
- Weight: 39 oz

Part No	Old No	Description
8.710-617.0	368158	48" Dual Trigger Lance
8.900-781.0	109490	Seal Kit

Legacy Vented Lances



- PSI: 5250
- Temperature: 300°F
- Handle made from molded glass-filled polyamide for heat dissipation with hollow insulators for increased heat venting
- Nozzle protector included
- 1/4" male inlet, 1/4" female outlet
- 4:1 safety factor
- Stainless-steel or high-quality chrome-plate finish

Part No	Description
Stainless-steel	
8.752-868.0	Lance, Vented, 20"
8.752-869.0	Lance, Vented, 24"
8.752-871.0	Lance, Vented, 36"
8.752-872.0	Lance, Vented, 48"
8.752-873.0	Lance, Vented, 60"
8.752-874.0	Lance, Vented, 79"
Chrome-plated	
8.752-875.0	Lance, Vented, 20"
8.752-876.0	Lance, Vented, 24"
8.752-878.0	Lance, Vented, 36"
8.752-879.0	Lance, Vented, 48"
8.752-880.0	Lance, Vented, 60"
8.752-881.0	Lance, Vented, 79"

AP Uninsulated Lances



Stainless-steel or corrosion-resistant, bright zinc-plated lances made with 1/4" tubing.



- PSI: 4100
- Temperature: 300°F
- Superior strength rolled threads
- 1/4" high-pressure, lightweight, thin-wall tubing

Part No	Old No	Length
Stainless-steel		
8.710-623.0	368212	12"
8.710-624.0	368220	20"
8.710-625.0	368224	24"
8.710-626.0	368228	28"
8.710-627.0	368236	36"
8.710-628.0	368248	48"
8.710-629.0	368260	60"
8.710-630.0	368278	78"
Zinc-plated		
8.710-631.0	368312	12"
8.710-632.0	368320	20"
8.710-633.0	368324	24"
8.710-634.0	368336	36"
8.710-635.0	368348	48"
8.710-636.0	368360	60"
8.710-637.0	368378	78"

NOTE: For 15° bend at lance discharge, place "BND" at end of the old part number.

Suttner Push and Pull Lance



Vented grip can be pushed and pulled up to 90°. For hard to reach applications, such as gutters, fenders, trucks and heavy equipment.

- PSI: 3050
- Temperature: 300°F
- 34" stainless-steel lance



Part No	Old No	Description
8.710-711.0	368880	ST-85 Push and Pull Lance

Big Stainless-Steel Lances and Side Handles

For big guns!



- PSI: 4050
- Temperature: 300°F
- High-pressure stainless-steel pipe
- Complete with adjustable handle and coupler for 1/4" MPT nozzle
- 1/2" MPT gun connection
- Schedule 40 pipe

Part No	Old No	Description
8.904-081.0	352902A	20" Wand w/ Handle
8.904-083.0	352904A	40" Wand w/ Handle
8.904-086.0	352906A	Side Handle Only
8.710-411.0		39", Stainless-Steel, 8700 PSI 300°F Inlet 1/2" MNPT, Outlet 1/4" MNPT

Lance Handles/Accessories

Vented grip, side handle with nut, and vented grip with side handle, can be user-attached to uninsulated lances or 1/4" steel pipe. Detachable and reusable!



Part No	Old No	Description
8.710-717.0	368909P	Vent Grip Only (14" long)
8.904-357.0	368909PS	Grip with Side Handle
8.904-358.0	368920P	Side Handle with Nut



Part No	Old No	Description
8.710-716.0	368909	Vent Grip Only (14" long) ST-9
8.710-719.0	368911	Grip with Side Handle
8.710-720.0	368920	Side Handle with Nut

MV Lance Handle



- Use on all 1/4" lances
- Easily positioned without removal of nozzle

Part No	Old No	Description
8.704-162.0	109873	1/4" Lance Handle

X-Jet Long Range Nozzle



8.710-474.0

- Projects water and chemical up to 40'
- Chemicals bypass pump, lance, hose and gun for damage protection
- Includes 15' hose with in-line shut-off valve and color-coded proportioners

Part No	Old No	Description
8.710-474.0*	360103	X-Jet Long Range Nozzle, 2000-3000 PSI
8.710-475.0*	360104	X-Jet Long Range Nozzle, 3000-4000 PSI
8.710-473.0	360102	M5 X-Jet Variable Fan, 2000-3000 PSI Long Range Nozzle

*Includes Close Range Nozzle

Replacement Accessories



- PSI: 4000
- Temperature: 300°F
- M22 – 1 O-ring inlet (standard)
- M22 – 2 O-ring outlet (extended)

Part No	Old No	Description
8.710-428.0	353070	Astra Style, 10.5 GPM
Maintenance Kits		
8.704-173.0	109950	Unitized Valve
8.704-174.0	109960	Trigger Seal Kit

Gutter Cleaner Attachment

Easily quick connect to any lance or extension wand to clean gutters or hard to reach areas. Angle improves reach and expands cleaning capabilities.



- PSI: 3500
- Temperature: 200°F
- Zinc-plated
- Inlet 1/4" M plug
- Inlet 1/4" F QC

Part No	Description
8.711-324.0	1/4" Nipple x 1/4" QC

Adjustable Nozzle Holder



- PSI: 5700
- GPM: 10
- Temperature: 300°F
- Perfect for cleaning hard-to-reach areas like inside containers or gutters
- Nozzle position locks with pressure
- Stainless-steel
- 1/4" female inlet



Part No	Description
8.749-905.0	Outlet 1/4" FNPT
8.749-906.0	Outlet 1/4" Male

Extension Wand Control Kit

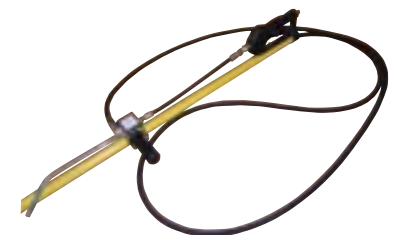
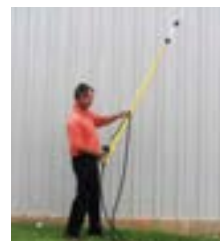

- Effortlessly raise and lower the wand using the water pressure
- Adjustable pressure
- No kick-back or whipping action
- Easy-grip handle
- Easy to install and control
- Right or left hand adjustable
- Durable, reliable, and lightweight
- Reduce fatigue and time on the job

Part No	Description
8.749-848.0	Extension Wand Control Kit

Spray-Flex™ Flex Wand

Gives easy access to difficult spots, great for cleaning engines, roofs, eaves or underneath almost anything! Holds its shape under pressure.



- PSI: 3000 and 5000
- Temperature: 190°F
- 90° flexibility

Part No	Old No	PSI
8.710-597.0	368117	3000
8.710-596.0	368116	5000

GUNS & LANCES

Fiberglass Telescoping Wands



High-quality telescoping wand reaches up to 24', three sizes to choose from. Lightweight and balanced under pressure.



Belt and pole clamp

- PSI: 4000
- GPM: 10.5
- Temperature: 195°F
- 6'-12' wand shown

Part No	Old No	Description
8.710-589.0	368090	6'-12'
8.710-590.0	368091	6'-18'
8.710-591.0	368092	6'-24'
8.700-059.0	056008	Strap and Belt Shoulder Harness
8.711-324.0		Gutter Cleaning Attachment

Replacement Guns

8.723-896.0		TS12 Replacement Gun
8.710-595.0	368098	TS18 Replacement Gun
8.739-434.0	368099	TS24 Replacement Gun

Hobby Gun, Lance and Hose

Don't turn away hobby-unit owners. Complete replacement hose, gun and lance!



8.711-285.0

9.802-223.0

Part No	Old No	Description
8.754-769.0	4-011137	Insulated Lance w/ Gun
9.112-526.0	4-011106	Lance w/ Coupler (Not Shown)
8.753-270.0	4-011105	Lance w/ #3 Hi/Low Varifan Nozzle
8.753-423.0	4-02010025M	1/4" x 25' Thermoplastic t, 22mm both ends

NOTE: See page 56 for more Hobby Hose

Legacy Industrial Gun & Lance



Gun and Lance combo



- PSI: 3500 / GPM: 10.4
- Temperature: 300°F
- Zinc-plated steel tubes
- Stainless-steel seat
- Includes nozzle protector
- 36" Square-molded grip lance with 1/4" quick coupled socket
- Weight: 39 oz

Part No	Description
8.904-095.0	Legacy Gun & Lance with 3/8" MPT QC Inlet

MV925 Gun & Lance Kit

- 3/8" MPT QC Nipple installed on inlet of gun
- 1/4" FPT QC Socket installed on outlet of lance
- 4000 PSI
- 8 GPM
- 36" Square Grip Lance



Part No	Old No
8.928-442.0	MV925 Gun

MV925 Gun, Lance, Hose Kit

- 3/8" MPT QC Nipple installed on inlet of gun
- 1/4" FPT QC Socket installed on outlet of lance
- R1 4000 PSI 3/8" x 50' black hose
- 2-3/8" FPT QC Sockets installed on hose
- 4000 PSI
- 8 GPM
- 36" Square Grip Lance



Part No	Old No
8.928-443.0	MV925 Gun

Flex Lances

Flexes a full 180° and returns, saving broken wand repairs.



- PSI: 2500
- Temperature: 200°F
- Prevents bent lances and broken hose
- Industrial-grade polyurethane flex section
- For self-serve car wash bays
- 1/4" galvanized pipe end sections

Part No	Old No	Description
8.710-598.0	368118	18", 1/4" MPT x 1/4" MPT
8.710-603.0	368121	21", 1/4" MPT x 1/8" FPT
8.710-604.0	368124	24", 1/4" MPT x 1/8" FPT

Pressure Washer Accessory Kit

Kit 1 includes:

- Teflon tape
- Hose, 3000 PSI 3/8 x 50', R1, SoxSw
- QC nozzle, Stainless-steel 1/4" #4.0x15
- Coupler, 3/8" female brass
- Wand, 18" M22 x 1/4" QC
- Gun, S2 3/8" inlet, lance w/ M22 coupler

Kit 2 includes:

- Teflon tape
- Hose, 5000 PSI 3/8 x 50', R2, SoxSw
- QC nozzle, Stainless-steel 1/4" #4.0x15
- Coupler, 3/8" female brass
- Wand, 18" M22 x 1/4" QC
- Gun, S2 3/8" inlet, lance w/ M22 coupler



Part No	Description
8.903-454.0	Pressure Washer Accessory Kit 1
8.903-455.0	Pressure Washer Accessory Kit 2

Hose - Legacy High-Pressure

For use with hot or cold-water pressure washers

Introducing the new Legacy hose. The Legacy hose is built to exceed the EN1829-2 Standard and will provide superior abrasion resistance that will increase the life of the hose. The Legacy hose is rated up to 250°F and is available in 4000 and 6000 PSI.

Both single-and double-wire braid hoses come with durable 8" bend restrictors on both ends.

The Legacy hose has a "bite-the-wire" coupling that grips the hose better than any other design.



- Temperature Rating: Legacy hoses are rated for continuous temperatures up to 250°F.
- Easily Identified: Permanently embossed identification makes for easy tracing and owner protection.

- Unique Coupling: A "bite-the-wire" coupling actually reaches the wire braid for never-slip retention, far superior to the "compression" fittings used on conventional hoses.

Hose - 1-Wire

- Black bend restrictor
- Rated to 250°F
- Smooth impression, oil resistant tube and black hose guard at both ends



Hose - 2-Wire

- Red bend restrictor
- Rated to 250°F
- Smooth impression, oil resistant tube and red hose guard at both ends



Part No	Size	Temperature	PSI
3/8" MPT Swivel x 3/8" MPT Solid, 3/8" ID			
8.925-176.0	3/8" x 15'	250 °F	4000
8.925-150.0	3/8" x 25'	250 °F	4000
8.925-156.0	3/8" x 50'	250 °F	4000
8.925-161.0	3/8" x 75'	250 °F	4000
8.925-165.0	3/8" x 100'	250 °F	4000
8.925-170.0	3/8" x 150'	250 °F	4000
8.925-350.0	3/8" x 200'	250 °F	4000
8.925-378.0	Case of 75 (8.925-156.0) 3/8" x 50' Hoses		
8.925-449.0	Case of 40 (8.925-165.0) 3/8" x 100' Hoses		
3/8" MPT Swivel x 3/8" MPT Swivel, 3/8" ID			
8.925-364.0	3/8" x 50'	250 °F	4000
8.925-365.0	3/8" x 75'	250 °F	4000
8.925-167.0	3/8" x 100'	250 °F	4000
8.925-367.0	3/8" x 150'	250 °F	4000
8.925-368.0	3/8" x 200'	250°F	4000
1/2" MPT Swivel x 3/8" MPT Solid, 1/2" ID			
8.925-236.0	1/2" x 50'	250°F	3000
8.925-237.0	1/2" x 75'	250°F	3000
8.925-238.0	1/2" x 100'	250°F	3000
1/4" MPT Swivel x 1/4" MPT Solid, 1/4" ID			
8.925-143.0	1/4" x 25'	250°F	3000
8.925-144.0	1/4" x 30'	250°F	3000
8.925-145.0	1/4" x 50'	250°F	3000
8.925-146.0	1/4" x 75'	250°F	3000
8.925-147.0	1/4" x 100'	250°F	3000

Part No	Size	Temperature	PSI
3/8" MPT Swivel x 3/8" MPT Solid, 3/8" ID			
8.928-542.0	3/8" x 15'	250 °F	6000
8.925-180.0	3/8" x 25'	250 °F	6000
8.925-184.0	3/8" x 50'	250 °F	6000
8.925-225.0	3/8" x 75'	250 °F	6000
8.925-229.0	3/8" x 100'	250 °F	6000
8.925-232.0	3/8" x 150'	250 °F	6000
8.925-369.0	3/8" x 200'	250 °F	6000
8.925-382.0	Case of 75 (8.925-184.0) 3/8" x 50' Hoses		
8.925-450.0	Case of 40 (8.925-229.0) 3/8" x 100' Hoses		
3/8" MPT Swivel x 3/8" MPT Swivel, 3/8" ID			
8.925-311.0	3/8" x 25'	250 °F	6000
8.925-313.0	3/8" x 50'	250 °F	6000
8.925-314.0	3/8" x 75'	250 °F	6000
8.925-316.0	3/8" x 100'	250 °F	6000
8.925-325.0	3/8" x 200'	250°F	6000
1/2" MPT Swivel x 1/2" MPT Solid, 1/2" ID			
8.925-247.0	1/2" x 50'	250°F	5000
8.925-249.0	1/2" x 75'	250°F	5000
8.925-253.0	1/2" x 100'	250°F	5000

HOSE & HOSE REELS

Hose - Rawhide 1-Wire 3000 PSI Smooth Non-Marking

Part No	Old Part No	Length	Temperature	Working PSI	Aprox Wt lbs
3/8" Smooth Yellow Hose					
8.901-800.0	158980	50' x 3/8" ID	250 °F	3000	12.0
8.901-802.0	158985	75' x 3/8" ID	250 °F	3000	17.0
8.901-804.0	158990	100' x 3/8" ID	250 °F	3000	23.0
8.705-720.0*	158900	Must be purchased in 500 ft reels			
3/8" Smooth Blue Hose					
8.925-311.0	158780	50' x 3/8" ID	250 °F	3000	12.0
8.925-313.0	158785	75' x 3/8" ID	250 °F	3000	17.0
8.925-314.0	158790	100' x 3/8" ID	250 °F	3000	23.0
8.925-316.0	158795	150' x 3/8" ID	250 °F	3000	34.0
8.925-325.0	158700	Must be purchased in 500 ft reels			
3/8" Smooth Gray Hose					
8.749-935.0		50' x 3/8" ID	250°F	3000	13.0
8.749-936.0		100' x 3/8" ID	250°F	3000	25.0
8.749-945.0*		Must be purchased in 500 ft reels			
1/4" Smooth Blue Hose					
8.901-796.0	158880	50' x 1/4" ID	250°F	3000	8.0
8.901-798.0	158890	100' x 1/4" ID	250°F	3000	16.0
8.705-718.0*	158800	Must be purchased in 500 ft reels			



*500 ft reel, 50 ft incremental lengths (max three pieces)

Hose - Legacy Rawhide 2-Wire 3/8" Blue

Part No	Old Part No	Length	Temperature	Working PSI	Aprox Wt lbs
3/8" Blue Hose - Smooth					
8.739-229.0	154415	50'	250 °F	4000	17.0
8.739-231.0	154425	100'	250 °F	4000	33.0
8.705-651.0*	154400	Must be purchased in 500 ft reels			



*500 ft reel, 50 ft incremental lengths (max three pieces)

Hose - 3/8" Gray - Wrapped

Part No	Description
3/8" Grey Hose - Wrapped	
8.921-617.0	3/8" x 25', 4K Gray A+ SOXSW
8.921-618.0	3/8" x 50', 4K Gray A+ SOXSW
8.921-619.0	3/8" x 75', 4K Gray A+ SOXSW
8.921-620.0	3/8" x 100', 4K Gray A+ SOXSW
8.752-156.0	3/8" Bulk, 4K Gray - Must be purchased in 600 ft reels



Hose - 3/8" Blue Tuff-Flex 2-Wire 6000 PSI



- Non-marking durable blue cover
- Red hose guard
- 50% greater flexibility
- 3/8" MPT swivel x 3/8" MPT solid
- Smooth impression, maximum oil-resistant tube and cover



Part No	Size	Temp	PSI
8.921-153.0	25' x 3/8" ID	250°F	6000
8.921-154.0	50' x 3/8" ID	250°F	6000
8.921-155.0	75' x 3/8" ID	250°F	6000
8.921-156.0	100' x 3/8" ID	250°F	6000
8.753-319.0	Must be ordered in 600' reel		

Hose - 3/8" Blue Tuff-Flex 1-Wire 4000 PSI



- Non-marking durable blue cover
- Red hose guard
- Smooth impression, maximum oil-resistant tube and cover
- 50% greater flexibility
- 3/8" MPT swivel x 3/8" MPT solid



Part No	Size	Temp	PSI
8.921-149.0	25' x 3/8" ID	250°F	4000
8.921-150.0	50' x 3/8" ID	250°F	4000
8.921-151.0	75' x 3/8" ID	250°F	4000
8.921-152.0	100' x 3/8" ID	250°F	4000
8.753-316.0	Must be ordered in 600' reel		

Pressure Loop - 1/4", 3/8" and 1/2", 2-Wire

The 1/4" ID pressure lines solid/swivel for most any application. The 3/8" ID pressure loops have female JIC on both ends for typical unloader connection hose. All pressure loops rate 275°F.

- 1/4" ID Pressure Loop
- 1/4" ID two-wire 5000 PSI
- 1/4" MPT swivel x 1/4" MPT solid
- Any length available



- JIC Pressure Loop
- 1/2" ID 4500 PSI
- 1/2" female JIC swivels - each end
- Any length available
- 3/8" ID two-wire 6000 PSI



Part No	Old No	Size	Description
8.918-180.0		16" x 1/4" ID	1/4" Pressure Loop
8.918-181.0		20" x 1/4" ID	1/4" Pressure Loop
8.918-182.0		26" x 1/4" ID	1/4" Pressure Loop
8.918-183.0		28" x 1/4" ID	1/4" Pressure Loop
8.918-184.0		30" x 1/4" ID	1/4" Pressure Loop
8.918-419.0		36" x 1/4" ID	1/4" Pressure Loop
8.918-187.0		42" x 1/4" ID	1/4" Pressure Loop
8.918-210.0		16" x 3/8" ID	JIC Pressure Loop
8.918-422.0		20" x 3/8" ID	JIC Pressure Loop
8.918-423.0		22" x 3/8" ID	JIC Pressure Loop
8.918-424.0		25" x 3/8" ID	JIC Pressure Loop
8.918-425.0		29" x 3/8" ID	JIC Pressure Loop
8.918-426.0		32" x 3/8" ID	JIC Pressure Loop
8.918-427.0		36" x 3/8" ID	JIC Pressure Loop
8.711-662.0	4-02047738	38" x 3/8" ID	JIC Pressure Loop
8.918-212.0		42" x 3/8" ID	JIC Pressure Loop
8.918-224.0		20" x 1/2" ID	JIC Pressure Loop
8.711-701.0	4-02067722	22" x 1/2" ID	JIC Pressure Loop
8.918-225.0		28" x 1/2" ID	JIC Pressure Loop
8.918-228.0		46" x 1/2" ID	JIC Pressure Loop
8.918-230.0		70" x 1/2" ID	JIC Pressure Loop

Hose - Whitewater® Combination Steam Hose



Good up to 3000 PSI / 250°F or 350 PSI / 325°F.

- Single high-tensile steel wire braid
- High temperature bend restrictors – both ends
- Seamless innertube
- Solid 3/8" or 1/2" MPT connectors – both ends (Swivel ends NOT available)
- Oil-resistant cover



Part No	Old No	Length
3/8" Hose		
8.901-599.0	153930	30'
8.901-601.0	153950	50'
8.901-598.0	153925	25'
8.901-603.0	153975	75'
8.901-604.0	153990	100'
8.705-643.0	153900*	Must be ordered in 500' reel
*Full Reel – 500 ft. per reel, hose only, 50 ft. incremental lengths (max three pieces)		
1/2" Hose		
8.901-721.0	155625	25'
8.901-723.0	155650	50'
8.901-724.0	155675	75'
8.901-725.0	155690	100'
8.705-678.0	155600*	Must be ordered in 500' reel
*Full Reel – 500 ft. per reel, hose only, 50 ft. incremental lengths (max three pieces)		

HOSE & HOSE REELS

Pulse Hose

- 1300 PSI working pressure
- 3/8" MPT on both styles
- Available with either plug-end or open-flow with solid/swivel connects



Part No	Old No	Description
8.711-151.0	381118	18" with Plug End
8.711-153.0	381124	24" with Plug End
8.711-155.0	381128	28" Solid/Swivel – Open
8.711-157.0	381136	36" Solid/Swivel – Open

Hobby Hose

Replacement hose for most hobby pressure washers sold by mass retailers.

- Thermoplastic cover
- Fiber-braid reinforcement
- 2250 PSI working pressure
- 9000 PSI burst pressure
- M22 x 1.5 fitting inlet
- 14mm seal cone fits Generac, Excell and Kärcher
- 15mm seal cone fits Campbell, MI-T-M



Seal Cone

Part No	Old No	Seal Cone	ID	Length
8.705-485.0	150245	14mm	1/4"	25'
8.705-487.0	150246	15mm	1/4"	25'
8.711-531.0	4-02010025M	22mm*	1/4"	25'

NOTE: See Hobby Gun and Lance on page 52.

*Both ends

Hose Bend Restrictors

- Used on hose assemblies
- Non-slip sure fit
- Easy installation, 325°F
- Top-quality molded fit bend restrictors
- Fits snugly to prevent kinks near the connectors



Part No	Old No	Size	Description
8.705-479.0	150166	5.3"	1/4" 1 wire, Black Vinyl
8.705-476.0	150161	6.0"	1/2" 1 wire, Black Vinyl
8.705-478.0	150164	6.0"	3/8" 2 wire, Red Vinyl
8.740-104.0		24.0"	3/8" 1 wire, Black Vinyl
8.711-846.0		24.0"	3/8" 2 wire, Red Vinyl
8.705-481.0	150170	7.0"	3/8" 1 wire, Black Vinyl
8.705-480.0	150168	7.0"	1/2" 2 wire, Red Vinyl
8.705-483.0	150174	6.5"	3/8" Combo, Gray Vinyl
8.705-482.0*	150172	6.5"	1/2" Combo, Black Rubber

*Insulated rubber

Garden Hose – Apex Quality

The essential product for pressure washing.



- Rated for cold-water user
- Assemblies complete with bend restrictor
- 5/8" or larger ID for full flow
- Choice of commercial or heavy-duty grade
- Reinforced hose for flexibility & strength in all weather
- Commercial grade has machined octago-I "wrench tight" fittings

Part No	Old No	Length	ID	Grade	Color
8.704-786.0	121315	50'	5/8"	Com	Gray
8.704-787.0	121319	100'	5/8"	Com	Gray
8.704-788.0	121332	50'	5/8"	HD Lt. Green	
8.704-789.0	121336	100'	5/8"	HD Lt. Green	
All Rubber Reinforced Hot Water (160°F) Hose					
8.704-790.0	121344	50'	5/8"	Com	Red
8.704-791.0	121348	50'	3/4"	Com	Red

See page 71 for garden hose fittings.

Sewer Hose

SUPER FLEXIBLE SEWER LINE HOSE AND COUPLINGS have small outside diameter, allowing hose and nozzles to fit through sewer line. Sewer line has super-tough poly-ether cover over ultra-flexible nylon tube. (1/8" sewer nozzle and hose will operate through many 1-1/2" lines.)

(Nozzles not included.)

- 160°F max temperature
- Nylon tube, polyether cover
- 1.5 GPM optimum flow 1/8"
- 2.5 GPM optimum flow 1/4"



Part No	Old No	Description
1/8" Hose – 4800 PSI, 1/4" inlet / 1/8" outlet		
8.751-927.0	150960	1/8" x 25'
8.705-602.0	150963	1/8" x 50'
8.705-603.0	150964	1/8" x 100'
1/4" Hose – 2600 PSI, 1/4" inlet / 1/4" outlet		
8.705-607.0	150968	1/4" x 50'
8.705-608.0	150970	1/4" x 100'
1/4" Hose – 4400 PSI, 1/4" inlet / 1/4" outlet		
8.705-610.0	150972	1/4" x 50'
8.705-611.0	150973	1/4" x 100'

Orange 600 Sprayer Hose and Ribbed PVC Sprayer Hose

Braid-reinforced PVC hose designed specifically for AG/Pest control spraying applications.

- Tough ribbed cover
- Color – orange
- 600 PSI max pressure
- Bulk hose standard in 300' single length coils
- Resists abrasion and UV rays



Part No	Old No	Description
3/8" Hose – Orange		
8.705-527.0	150630	300' Coil (Single, Uncut Length)
8.901-384.0	150634	50' Length (Bulk)
8.901-385.0	150636	100' Length (Bulk)
8.901-383.0	150632	Per Foot (Minimum 25') hose only
1/2" Hose – Orange		
8.705-523.0	150601	300' Coil (Single, Uncut Length)
8.901-377.0	150603	50' Length
8.901-379.0	150606	100' Length
8.705-524.0	150602	Per Foot (Minimum 25') hose only
3/4" Hose – Orange		
8.705-531.0	150660	300' Coil (Single, Uncut Length)
8.901-386.0	150660	Per Foot (Minimum 25') hose only

Cold Weather Garden Hose

- Ideal for outdoor contractors
- 5/8" – 50 ft.
- High-quality brass fittings
- Heated hose with 110 plug
- Thermostatically controlled — heating element is activated at +/- 35°F temperature and turned off at +/- 40°F ambient temperature
- Use only with a UL approved GFCI outlet or extension
- PVC material FDA-approved for potable water



Part No	Description
8.749-944.0	50' Cold Weather Garden Hose

See page 71 for garden hose fittings.

Vinyl Tubing

This 1/4" x 1/2" clear vinyl tubing is heavier duty than the rest! Thick wall resists kinking. Available in clear or clear-reinforced with a polyester braid.

- Very flexible
- Available by the foot or 100' rolls



Part No	Old No	ID	PSI	Description
9.802-251.0	4-02080000	1/4" x 1/2"	50	Clear vinyl / ft
9.802-252.0	4-02090000	1/4" x 1/2"	250	Braided vinyl / ft
8.711-733.0		3/8" x 1/2"	100	Sold by the foot

Clear Reinforced PVC Tubing

Multi-use, industrial-grade tubing with high-resistance to chemicals, solvents and fuel.

- Reinforced with polyester cord
- Huge selection of sizes and lengths
- 4-to-1 burst safety factor



Part No	Old No	ID x OD	WP@70°F	Roll Length
8.901-256.0	121031	1/4" x 3/8"	250	25'
8.901-257.0	121032	1/4" x 3/8"	250	50'
8.704-751.0	121033	1/4" x 3/8"	250	100'
8.704-752.0	121034	1/4" x 3/8"	250	300'
8.901-260.0	121036	3/8" x 1/2"	175	25'
8.901-261.0	121037	3/8" x 1/2"	175	50'
8.901-262.0	121038	3/8" x 1/2"	175	100'
8.704-753.0	121039	3/8" x 1/2"	175	300'
8.901-264.0	121041	1/2" x 3/4"	175	25'
8.901-265.0	121042	1/2" x 3/4"	175	50'
8.704-754.0	121043	1/2" x 3/4"	175	100'
8.704-755.0	121044	1/2" x 3/4"	175	300'
8.901-263.0		1/2"	175	per ft
8.901-267.0	121046	5/8" x 7/8"	175	25'
8.901-268.0	121047	5/8" x 7/8"	140	50'
8.901-269.0	121048	5/8" x 7/8"	140	100'
8.704-756.0	121049	5/8" x 7/8"	140	300'
8.901-266.0		5/8"	140	per ft
8.901-271.0	121051	3/4" x 1"	140	25'
8.901-272.0	121052	3/4" x 1"	140	50'
8.704-757.0	121053	3/4" x 1"	140	100'
8.704-758.0	121054	3/4" x 1"	140	300'
8.901-270.0		3/4"	140	per ft
8.901-273.0	121059	1" x 1 1/4"	75	25'
8.901-274.0	121060	1" x 1 1/4"	75	50'
8.901-275.0	121061	1" x 1 1/4"	75	100'
8.704-759.0	121063	1" x 1 1/4"	75	200'
8.901-276.0		1"	75	per ft

See page 71 for hose clamps.

Crimp Fittings



Part No	Description	Hose
8.724-027.0	3/8" MPT, Solid	3/8"
8.724-028.0	3/8" MPT, Swivel	3/8"
8.724-029.0	1/2" FJIC, Solid	3/8"
8.706-759.0	3/8" FPT, Swivel	3/8"

HOSE & HOSE REELS

“Field” Attachable Couplings

Design and build your own hose or adapt and repair hose in the field (no crimper required).



Couplings for 1-Wire Braid Hose

Part No	Old No	ID x MPT
8.705-493.0	150502	1/4" x 1/4" – Solid
8.705-495.0	150505	1/4" x 1/4" – Swivel
8.705-496.0	150510	3/8" x 1/4" – Solid
8.705-497.0	150511	3/8" x 3/8" – Solid
8.705-498.0	150513	3/8" x 3/8" – Swivel
8.705-499.0	150515	1/2" x 3/8" – Solid
8.705-500.0	150516	1/2" x 1/2" – Solid
8.705-501.0	150518	1/2" x 1/2" – Swivel

Couplings for 2- Wire Braid Hose

Part No	Old No	ID x MPT
8.705-502.0	150532	1/4" x 1/4" – Solid
8.705-503.0	150535	1/4" x 1/4" – Swivel
8.705-504.0	150540	3/8" x 1/4" – Solid
8.705-505.0	150541	3/8" x 3/8" – Solid
8.705-506.0	150543	3/8" x 3/8" – Swivel
8.705-507.0	150546	1/2" x 1/2" – Solid
8.705-508.0	150548	1/2" x 1/2" – Swivel

Clear PVC Tubing

- “Box Pak” 100 ft.
- 25°F to 150°F
- Very flexible, non-reinforced
- Packaged in self-dispensing box



Part No	Old No	ID	OD	WP @ 70°F
8.901-279.0	121070	1/4"	3/8"	55
8.704-766.0	121106	1/2"	5/8"	30

Flex Line Bypass / Supply Line Hose

Industrial PVC hose with black seamless inner tube, polyester braid reinforced tough outer cover. Excellent for use as supply lines or bypass lines. Typically used for air hose.



- Looks and feels like rubber
- Smooth dirt- and oil-resistant finish
- Super flexible
- Abrasion-resistant cover
- Burst-rated three-times WP

Part No	Old No	ID x OD	WP@70°F	Roll Length
Red Cover, heavy wall				
8.901-281.0	121081	3/8" x .634"	300	50'
8.704-762.0	121084	3/8" x .634"	300	500'
8.901-282.0	121087	1/2" x .792"	250	50'
8.704-764.0	121090	1/2" x .792"	250	500'
8.901-284.0	121097	3/4" x 1.14"	160	50'
8.704-765.0	121099	3/4" x 1.14"	160	300'
Blue Cover, standard wall				
8.704-779.0	121160	1/4" x .475"	250	100'

Connector Hose – 2'-10'

Connector hose comes with one solid / one swivel end.



3/8" Ultima – 2-wire w/o Bend Restrictors

Part No	Length	PSI	Hose Color
8.918-271.0	2'	6000	Black
8.918-273.0	3'	6000	Black
8.918-276.0	4'	6000	Black
8.918-278.0	5'	6000	Black
8.918-280.0	6'	6000	Black
8.918-282.0	7'	6000	Black
8.918-284.0	8'	6000	Black
8.918-420.0	9'	6000	Black
8.918-288.0	10'	6000	Black

3/8" Ultima – 2-wire with Bend Restrictors

Part No	Length	PSI	Hose Color
8.918-272.0	2'	6000	Black
8.918-275.0	3'	6000	Black
8.918-277.0	4'	6000	Black
8.918-209.0	5'	6000	Black
8.918-281.0	6'	6000	Black
8.918-283.0	7'	6000	Black
8.918-285.0	8'	6000	Black
8.918-287.0	9'	6000	Black
8.918-289.0	10'	6000	Black

1/2" Ultima – 2-wire w/o Bend Restrictors

Part No	Length	PSI	Hose Color
8.918-292.0	2'	5000	Black
8.918-294.0	3'	5000	Black
8.918-296.0	4'	5000	Black
8.918-298.0	5'	5000	Black
8.918-300.0	6'	5000	Black
8.918-301.0	7'	5000	Black
8.918-302.0	8'	5000	Black
8.918-303.0	9'	5000	Black
8.918-304.0	10'	5000	Black

Connector Hose – 2'-10'

Connector hose comes with one solid / one swivel end.



3/8" Ultima – 1-wire w/o Bend Restrictors

Part No	Length	PSI	Hose Color
8.918-253.0	2'	4000	Black
8.918-255.0	3'	4000	Black
8.918-257.0	4'	4000	Black
8.918-259.0	5'	4000	Black
8.918-261.0	6'	4000	Black
8.918-263.0	7'	4000	Black
8.918-265.0	8'	4000	Black
8.918-267.0	9'	4000	Black
8.918-269.0	10'	4000	Black

1/4" Ultima – 1-wire w/o Bend Restrictors

Part No	Length	PSI	Hose Color
8.918-240.0	2'	4000	Black
8.918-241.0	3'	4000	Black
8.918-242.0	4'	4000	Black
8.918-243.0	5'	4000	Black
8.918-245.0	6'	4000	Black
8.918-247.0	7'	4000	Black
8.918-248.0	8'	4000	Black
8.918-250.0	9'	4000	Black
8.918-251.0	10'	4000	Black

Connector Hose / Car Wash Bay Hose – 12'-25'

All car wash bay hoses come with solid male pipe on both ends.



3/8" Ultima – 1-wire 4000 PSI, w/o Bend Restrictors

Part No	Length	PSI
8.918-333.0	12'	4000
8.918-334.0	13'	4000
8.918-336.0	14'	4000
8.918-338.0	15'	4000
8.918-340.0	16'	4000
8.918-342.0	17'	4000
8.918-344.0	18'	4000
8.918-348.0	20'	4000

3/8" Blue – 1-wire 3000 PSI, w/o Bend Restrictors

Part No	Length	PSI
8.918-360.0	12'	3000
8.918-366.0	15'	3000
8.919-124.0	16'	3000
8.918-369.0	17'	3000
8.918-371.0	18'	3000
8.918-375.0	20'	3000

3/8" Ultima – 1-wire with Bend Restrictors One End

Part No	Length	PSI
8.919-123.0	12'	4000
8.918-335.0	13'	4000
8.918-337.0	14'	4000
8.918-339.0	15'	4000
8.918-349.0	20'	4000

3/8" Blue – 1-wire with Bend Restrictors One End

Part No	Length	PSI
8.918-361.0	12'	3000
8.918-367.0	15'	3000
8.918-368.0	16'	3000
8.918-372.0	18'	3000
8.918-376.0	20'	3000

1/4" Blue – 1-wire w/o Bend Restrictors

Part No	Length	PSI
8.918-387.0	12'	3000
8.918-389.0	13'	3000
8.918-391.0	14'	3000
8.918-393.0	15'	3000
8.918-395.0	16'	3000
8.918-397.0	17'	3000
8.918-399.0	18'	3000
8.918-401.0	19'	3000
8.918-403.0	20'	3000
8.918-405.0	21'	3000
8.918-407.0	22'	3000
8.918-409.0	23'	3000
8.918-411.0	24'	3000
8.918-413.0	25'	3000

1/4" Blue – 1-wire with Bend Restrictors One End

Part No	Length	PSI
8.918-388.0	12'	3000
8.918-390.0	13'	3000
8.918-392.0	14'	3000
8.918-394.0	15'	3000
8.918-396.0	16'	3000
8.918-398.0	17'	3000
8.918-400.0	18'	3000
8.918-402.0	19'	3000
8.918-404.0	20'	3000
8.918-406.0	21'	3000
8.918-408.0	22'	3000
8.918-410.0	23'	3000
8.918-412.0	24'	3000
8.918-414.0	25'	3000

Legacy Stackable Hose Reels



Hose reels built specifically for contractors who require flexibility on a job site. Stackable reels are supported on both sides of the central hub to accommodate more aggressive applications, such as trailer-mounted.



200' Mild Steel Stackable Hose Reel

100' Mild Steel Stackable Hose Reel

- Integrated frame adds protection and stacking ability
- Stacked up to 3 high
- Heavy-duty powder-coated steel or stainless steel
- Reel and swivel rated up to 6000 PSI and 350°F
- Modular design is able to configure for various needs
- Reversible hand-crank and swivel

Part No	Description
9.801-767.0	Stackable Hose Reel, Mild Steel, 100'
9.801-768.0	Stackable Hose Reel, Mild Steel, 200'
9.801-769.0	Stackable Hose Reel, Stainless Steel, 100'
9.801-770.0	Stackable Hose Reel, Stainless Steel, 200'

NOTE: Hose not included

Part No	Description
8.923-415.0	Hose Guide, 100' Reel
8.923-427.0	Hose Guide, 200' Reel
8.923-416.0	Hose Reel Riser
8.923-918.0	Reel Cart System



Stainless Steel Stackable Hose Reel

200' Mild Steel Stackable Hose Reel with Optional Hose Guide and Hose Reel Riser

200' Mild Steel Stackable Hose Reels with Optional Reel Cart System and Hose Guide

Options



Reel Cart System

Hose Reel Riser

Hose Guide

* Patent D739,715S and other Patents Pending

Legacy Hose Reels



Legacy hose reels were designed for ease of use and durability in commercial pressure washer applications. Offering 100' and 200' reels in both a fixed base and 360 degree rotating base. The oversized reel holds the advertised length plus leaves additional space reducing the difficulty of reeling hose. The unique extended swivel improves the hose connection and reduces hose wear and stress.



Fixed Base Hose Reel



360° Pivot Reel

- 5000 PSI
- 325°F
- 100'- and 200'-fixed base
- 100'- and 200'-360° rotating base
- High-pressure, double-seal swivels
- Reels equipped for 3/8" hose. Easily convertible to 1/2" hose with the change to a 1/2" swivel
- 2-year warranty

Bracket Sockets



Universal Mount



Skid Mount



Wall Mount



Base Mount

Non-Pivot Reel Brackets



Universal



90°



45°



Vertical

Part No	Description
8.750-485.0	Pivot Reel, 100' x 3/8"
8.750-482.0	Pivot Reel, 200' x 3/8"
8.750-476.0	Fixed Based, 100' x 3/8"
8.750-479.0	Fixed Based, 200' x 3/8"

NOTE: Hose not included

Part No	Description
8.919-430.0	Universal Mount
8.919-794.0	Skid Mount
8.919-437.0	Wall Mount
8.919-434.0	Base Mount
8.919-072.0	Bracket, Universal
8.919-445.0	Bracket, 90°
8.919-441.0	Bracket, 45°
8.919-448.0	Bracket, Vertical

Legacy Hose Reel Swivels



- Innovative design
- 5000 PSI
- Stainless-steel rotor
- Unique dual seal for extra long life
- 2-year warranty



- Limits bend and hose stress
- 5000 PSI
- Stainless-steel rotor
- Unique dual seal for extra long life
- 2-year warranty

Swivels

Part No	Inlet x Outlet
9.118-021.0	1/2" M x 3/8" F
9.118-022.0	1/2" F x 3/8" F
9.118-023.0	3/8" M x 3/8" F
9.118-024.0	3/8" F x 3/8" F
9.118-025.0	1/2" M x 1/2" F
9.118-026.0	1/2" F x 1/2" F
9.118-027.0	3/8" M x 1/2" F
9.118-028.0	3/8" F x 1/2" F

Extended Swivels

Part No	Inlet x Outlet
9.118-020.0	1/2" M x 3/8" F
9.118-029.0	1/2" F x 3/8" F
9.118-030.0	3/8" M x 3/8" F
9.118-031.0	3/8" F x 3/8" F
9.118-034.0	1/2" F x 1/2" F
9.118-035.0	1/2" M x 1/2" F
9.118-032.0	3/8" F x 1/2" F
9.118-033.0	3/8" M x 1/2" F

Universal Repair Kit

Part No
8.776-001.0

AP Hose Reels



AP hose reels have been designed to perfectly balance ruggedness and durability with affordability.



Swivel Repair Kits

Part No	Old No
8.900-855.0	110025

- Flared flanges for maximum capacity
- Solid center core for maximum strength
- Rolled, beaded-edge flanges for maximum safety
- Easy mounting options for maximum versatility
- "Posi-Pin" lock prevents unwanted dereeling
- Heavy-duty powder-coated steel
- Easy access external swivel
- 4000 PSI working pressure
- Rated temperature: 225°F
- 3/8" or 1/2" inlet/outlet

Part No	Old No	Hose Dia	Capacity (in feet)	Core Width	Flange Width	Flange Diameter	Overall Height
8.711-192.0	386188	3/8"	50	4.3	7.9	10.5	13.0"
9.804-067.0	386191	3/8"	100	8.7	12.2	10.5	13.0"
8.711-199.0	386206	3/8"	150	6.3	10.2	13.0	16.7"
8.711-201.0	386209	1/2"	100	6.3	10.2	13.0	16.7"
8.712-460.0	421043	Replacement Swivel for Part No 8.711-192.0 and 9.804-067.0					
8.712-469.0	421063	Replacement Swivel for Part No 8.711-199.0					
8.754-280.0	421045	Replacement Swivel for Part No 8.711-201.0					
8.700-188.0	4-0203612	Replacement Handle					

NOTE: Hose is not included. See page 59 for connector hose.



Swivel Repair Kits

Part No	Old No	Dia
8.700-287.0	075130	3/8"
8.700-285.0	075128	1/2"
8.900-855.0*	110025	

*For Round Swivels

Replacement Swivels – see page 67.

- Super-reinforced core — won't collapse!
- Adjustable brake for controlled reel tension
- Convenient external swivel
- Manual rewind handle included
- Solid core bolts on to flanges for extra strength
- 225°F max temperature
- Snap-lock to prevent accidental dereeling
- Bearings have oil cap for easy field Maintenance
- 4000 PSI working pressure

Professional Size Reel

Part No	Old No	Hose Dia	Capacity (in feet)	Reel Size Width	Reel Size Diameter
8.711-182.0	386174	3/8"	150	6"	18"
8.711-183.0	386175	3/8"	300	10"	18"
8.711-184.0	386176	3/8"	350	14"	18"
8.711-189.0	386181	1/2"	200	10"	18"
8.711-190.0	386182	1/2"	270	14"	18"
8.715-921.0	600975T	Replacement Brake for Part No 8.711-182.0 and 8.711-183.0			

NOTE: Hose is not included. Interchangeable parts available. See page 59 for connector hose.

Space Saver Reel

Part No	Old No	Hose Dia	Capacity (in feet)	Reel Size Width	Reel Size Diameter
8.711-179.0	386171	3/8"	90	6"	14"
8.711-180.0	386172	3/8"	140	10"	14"
8.711-181.0	386173	3/8"	200	14"	14"
8.711-186.0	386178	1/2"	115	10"	14"
8.711-187.0	386179	1/2"	150	14"	14"

NOTE: Hose is not included. Interchangeable parts available. See page 59 for connector hose.

Coxreels Hose Reels



Coxreels offer high performance in a very compact and lightweight hand crank or spring-driven hose reel. Perfect for mobile application and permanent floor and wall mount.



8.711-858.0

- Rated up to 4000 PSI
- -20°F to 225°F
- Adjustable drag brake
- 90° brass swivel

Part No	Old No	Description	PSI
8.711-858.0	4-02750001	200' x 1/2" (300' x 3/8" with Adapter)	3000
8.711-860.0	4-02750002	100' x 3/8"	4000
9.802-265.0	4-02750003	150' x 3/8"	4000
8.711-591.0	4-020369	Handle Replacement	
8.711-588.0	4-020366	Locking Pin Assy	
8.723-649.0	87236490	50' x 3/8" Spring Driven	4000
8.705-132.0	140407	1/2" to 3/8" Adapter (for 8.711-858.0)	
8.750-020.0		Ball Stop for 8.723-649.0	
8.711-584.0	4-020362	Replacement Swivel, 1/2"	
8.711-585.0	4-020363	Replacement Swivel, 3/8"	



9.802-265.0

- Spring Driven Hose Reel
- Lightweight, compact design
- Adjustable drag break
- Sturdy U-shaped frame
- Up to 4000 PSI
- Rolled edges and ribbed discs provide strength and safety
- Pro-grade heavy-duty steel
- 2-year mfg. limited warranty



8.723-649.0 (hose and ball stop not included)

Quick Couplers



Brass Couplers, designed for 4000 PSI and extended durability. Affordable and rugged all in one.



- Precision brass design
- Stainless-steel band for increased durability (except 1/2")
- Unrestricted free-flow
- 4000 PSI max

Part No	Old No	Description	Case Lot Part No
9.802-164.0	2-2000	1/4" FPT8.916-538.0	Case of 200 Couplers
9.802-166.0	2-2002	3/8" FPT8.916-537.0	Case of 200 Couplers
8.707-166.0	2-20180	1/2" FPT	
9.802-165.0	2-2001	1/4" MPT8.916-542.0	Case of 200 Couplers
9.802-169.0	2-2003	3/8" MPT8.916-541.0	Case of 200 Couplers
8.707-167.0	2-20181	1/2" MPT	

Case Lot Part No	Description
8.916-538.0	Case of 200 Couplers, 1/4" FPT
8.916-537.0	Case of 200 Couplers, 3/8" FPT
8.916-542.0	Case of 200 Couplers, 1/4" MPT
8.916-541.0	Case of 200 Couplers, 3/8" MPT



- Zinc-plated
- Hardened steel
- 4000 PSI max

Steel Nipples, hardened steel combined with zinc yellow chromate plating holds up to the harshest environments.

Part No	Old No	Description	Case Lot Part No
8.707-136.0	2-2004	1/4" FPT8.916-361.0	Case of 200 Nipples
8.707-137.0	2-20040	1/4" x 1/8" FPT	
9.802-170.0	2-2006	3/8" FPT8.916-536.0	Case of 200 Nipples
8.707-165.0	2-2018	1/2" FPT	
8.707-139.0	2-2005	1/4" MPT8.916-540.0	Case of 200 Nipples
9.802-171.0	2-2007	3/8" MPT8.916-539.0	Case of 200 Nipples
8.707-164.0	2-2017	1/2" MPT	

Case Lot Part No	Description
8.916-361.0	Case of 200 Nipples, 1/4" FPT
8.916-536.0	Case of 200 Nipples, 3/8" FPT
8.916-540.0	Case of 200 Nipples, 1/4" MPT
8.916-539.0	Case of 200 Nipples, 3/8" MPT

Stainless-Steel Quick Couplers



- Chemical-resistant
- 303 stainless-steel
- 6000 PSI

Part No	Old No	Description
8.707-110.0	2-2001SS	1/4" MPT Stainless-steel Couplers
8.707-135.0	2-2003SS	3/8" MPT Stainless-steel Couplers
8.707-140.0	2-20051	1/4" MPT Stainless-steel Nipples
8.707-152.0	2-20071	3/8" MPT Stainless-steel Nipples
8.707-103.0	2-2000SS	1/4" FPT Stainless-steel Couplers
8.707-125.0	2-2002SS	3/8" FPT Stainless-steel Couplers
8.707-138.0	2-20041	1/4" FPT Stainless-steel Nipples
8.707-144.0	2-20061	3/8" FPT Stainless-steel Nipples

O-Rings

O-Rings for AP, Hansen, Foster, Parker, and other quick-coupler brands. Buna to 210°F, EPDM to 280°F and Viton to 300°F and aggressive chemicals.



QC EPDM

Part No	Old No	QC Size
8.900-026.0	075033	1/8"
9.802-098.0	075035	1/4"
9.802-102.0	075037	3/8"

QC Buna

Part No	Old No	QC Size
8.900-027.0	075034	1/4"
8.702-017.0	075036	3/8"
8.900-030.0	075038	1/2"

QC Viton

Part No	Old No	QC Size
8.702-084.0	075042	1/4"
8.702-088.0	075041	3/8"
8.900-032.0	075040	1/2"

Quick Connective Couplers - Foster



- Precision performance
- Unrestricted bore for free flow
- Resists plug deformation when pressure spikes occur and withstands pump pulse



Part No	Description
8.756-030.0	Coupler, 1/4" Socket, Male, Brass
8.756-031.0	Coupler, 1/4" Socket, Female, Brass
8.756-032.0	Coupler, 3/8" Socket, Male, Brass
8.756-033.0	Coupler, 3/8" Socket, Female, Brass
8.756-034.0	Coupler, 1/2" Socket, Female, Brass
8.756-035.0	Coupler, 1/4" Plug, Male, Steel
8.756-036.0	Coupler, 1/4" Plug, Female, Steel
8.756-037.0	Coupler, 3/8" Plug, Male, Steel
8.756-038.0	Coupler, 3/8" Plug, Female, Steel
8.756-039.0	Coupler, 3/8" Plug, Male, S/S
8.756-040.0	Coupler, 3/8" Plug, Female, S/S
8.756-041.0	Coupler, 1/2" Plug, Male, Steel
8.756-042.0	Coupler, 1/2" Plug, Female, Steel

Couplers - Quick Connective

Pressure Rating Service

Series	Steel Plug PSI	Brass Plug PSI	Stainless-steel PSI
1/8"	2600	2500	4200
1/4"	5500	5200	6700
3/8"	3500	2700	6300
1/2"	2700	2200	3000
3/4"	1700	1700	1700

Part No	Old No	Description
8.709-436.0	331010	1/8" MPT Brass Coupler Socket
8.709-463.0	331045	3/4" MPT Brass Coupler Socket
8.709-462.0	331044	3/4" FPT Brass Coupler Socket
8.709-438.0	331012	1/8" Stainless-Steel MPT Coupler Socket
8.709-444.0	331017	1/4" Stainless-Steel FPT Coupler Socket
8.709-564.0	331413	3/8" Stainless-Steel FPT Coupler Socket
8.709-457.0	331031	1/2" Stainless-Steel FPT Coupler Socket
8.709-478.0	331110	1/8" MPT Plugs, Steel, Zinc-plated
8.709-479.0	331111	1/8" FPT Plugs, Steel, Zinc-plated
8.709-502.0	331127	3/4" MPT Plugs, Steel, Zinc-plated
8.709-509.0	331144	3/4" FPT Plugs, Steel, Zinc-plated
8.709-486.0	331117	1/4" MPT Plugs, Hardened Stainless-Steel
8.709-488.0	331118	1/4" FPT Plugs, Hardened Stainless-Steel
8.709-480.0	331112	1/2" MPT Plugs, Hardened Stainless-Steel
8.709-481.0	331113	1/2" FPT Plugs, Hardened Stainless-Steel

Quick Couplers - 11,000 PSI

Snaptite Quick Sockets and Plugs are precision-built for extreme high pressure.



- 11,000 PSI max
- -40°F to 250°F
- Zinc chromate

Part No	Old No	Description
8.707-115.0	2-20023	1/4" FPT Socket
8.707-116.0	2-200231	1/4" MPT Socket
9.802-167.0	2-20021	3/8" FPT Socket
8.707-117.0	2-20024	1/4" FPT Plug
8.707-121.0	2-20028	1/4" MPT Plug
9.802-168.0	2-20022	3/8" FPT Plug
8.707-120.0	2-20027	3/8" MPT Plug
9.804-043.0	2-0132	1/4" SEAL, U-Pack
8.706-712.0	2-01321	3/8" SEAL, U-Pack

Twist Seal Couplers

Allows U.S.-standard hose to connect to European (22mm) fittings.

- Internal O-ring seal
- Machined-brass body
- High-impact plastic knob
- 7.8 GPM max flow
- 3600 PSI max pressure
- 302°F max temperature
- Not threaded



(Not threaded)

Part No	Old No	Description
8.709-522.0	331205	1/4" FPT
8.709-530.0	331207	3/8" FPT
9.802-173.0	331204	1/4" MPT
8.709-526.0	331206	3/8" MPT
8.709-601.0	331710	3/8" QD Plug
8.709-554.0		3/8" QD Plug

Plugs are made of heavy-duty machined-brass for a safe and leak-free connection.



Part No	Old No	Description
8.709-540.0	331305	1/4" FPT
8.709-546.0	331307	3/8" FPT
8.709-536.0	331304	1/4" MPT
8.707-185.0	331306	3/8" MPT

O-rings, Viton

Part No	Old No	Description
8.756-782.0		O-rings (Viton)

COUPLERS, FITTINGS & FILTERS

Twist Seal Couplers

Couples U.S.-standard pipe threads to 22mm European fittings found on imported pressure washers.

- Internal O-ring with back ring seal assures no-leak operation
- Oversized high-impact plastic knob
- Machined-brass body
- 7.8 GPM max flow
- 4000 max pressure
- 302°F max temperature
- 3.9 to 4.2 oz weight



Sockets

Part No	Old No	Description
8.709-524.0	331205PA	1/4" FPT
8.709-531.0	331207PA	3/8" FPT
8.709-534.0	331209PA	1/2" FPT
8.709-521.0	331204PA	1/4" MPT
8.709-528.0	331206PA	3/8" MPT
8.709-533.0	331208PA	1/2" MPT



Plugs

Part No	Old No	Description
8.709-542.0	331305PA	1/4" FPT
8.709-548.0	331307PA	3/8" FPT
8.709-553.0	331309PA	1/2" FPT
8.709-539.0	331304PA	1/4" MPT
8.709-551.0	331308PA	1/2" MPT



O-rings

Part No	Old No	Description
8.704-036.0	109286	O-rings, 22 mm viton
8.704-037.0	109287	Back Ring, 2.4 x 9.3

Extended Twist Seal Coupler

- PSI: 3600
- GPM: 11
- Temperature: 300°F
- Double O-ring seal
- Machined-brass body
- High-impact plastic knob



Part No	Old No	Description
8.709-535.0	331215	Coupler – 1/4" FPT x 22 mm F
8.709-555.0	331315	Plug – 1/4" FPT x 22 mm M

Double Shut-Off Couplers and Plugs

- Quick disconnect without drips and leaks
- Indispensable for in-plant multiple station systems
- Machined-construction brass, zinc-plated steel or stainless-steel



8.709-580.0



8.709-556.0

Part No	Old No	Description	PSI
8.709-556.0	331401	1/8" FPT Socket (Brass)	3000
8.756-043.0	331405	1/4" FPT Socket (Brass)	2700
8.756-044.0	331406	3/8" FPT Socket (Stl Zinc)	3700
8.709-559.0	331407	3/8" FPT Socket (Brass)	2200
8.709-560.0	331408	1/2" FPT Socket (Brass)	2250
8.709-561.0	331409	1/2" FPT Socket (Stainless-Steel)	4250
8.709-562.0	331410	3/4" FPT Socket (Brass)	2000
8.709-580.0	331501	1/8" FPT Plugs (Brass)	3000
8.709-583.0	331507	3/8" FPT Plugs (Brass)	2200
8.709-584.0	331508	1/2" FPT Plugs (Brass)	2250
8.709-582.0	331506	3/8" FPT Plugs (Steel / Zinc)	2250

Foster Double Shut-Off Quick Couplers



8.756-843.0



8.756-844.0

Part No	Description
8.756-043.0	Coupler Socket, Double Shut Off, 1/4" FPT Brass
8.756-044.0	Coupler Plus, Double Shut Off, 1/4" FPT Brass



Replacement O-rings

- Nitrile up to 210°F
- Use Viton for 230°F and above

Part No	Old No	Description
8.701-994.0	ORN013	O-ring 1/8" Nitrile
8.702-015.0	ORN110	O-ring 1/4" Nitrile
8.702-017.0	ORN112	O-ring 3/8" Nitrile
8.702-021.0	ORN114	O-ring 1/2" Nitrile
8.702-084.0	ORV110	O-ring 1/4" Viton
8.702-088.0	ORV112	O-ring 3/8" Viton
8.702-090.0	ORV114	O-ring 1/2" Viton
8.702-023.0	ORN115	O-ring 3/32" Nitrile (for kit 1)

Quick Couplers - Brass

Designed for 4000 PSI and extended durability. EPDM O-rings as standard. Affordable and rugged all in one.



Part No	Description
8.750-695.0	Coupler 1/4" Socket FPT
8.750-696.0	Coupler 1/4" Socket MPT
8.750-697.0	Coupler 3/8" Socket FPT
8.750-698.0	Coupler 3/8" Socket MPT

Swivels - 90°

Excellent for car wash booms and hose reels. Remarkable value, comparable to best swivels made.



- Forged-brass body
- 4000 PSI
- 225°F
- Nitrile O-ring

Part No	Old No	Description
8.712-460.0	421043	3/8" M x 3/8" F
8.712-461.0	421044	3/8" F x 3/8" F
8.712-462.0	421045	1/2" M x 1/2" F
8.712-463.0	421046	1/2" F x 1/2" F
8.712-464.0	421047	1/2" M x 3/8" F
8.712-469.0	421063	3/8" F x 3/4" M w/ 3/8" inside thread
8.900-855.0	110025	Repair Kit

Swivels – Right Angle



8.712-449.0



8.712-448.0

- 360° swivel rotation
- 3000 PSI max pressure (brass)
- 5000 PSI max pressure (stainless-steel)

Part No	Old No	Description
8.712-448.0	421018	Swivel – Stainless-steel 3/8"
8.712-450.0	421020	Swivel – Brass 3/8"
8.712-449.0	421019	Swivel – Brass 1/2"
8.700-287.0	075143	Repair Kit – 3/8" for 421018 and 421020
8.700-285.0	075128	Repair Kit – 1/2" for 421019

Swivels - Stainless-Steel, High-Pressure and Economy Brass



- 10.5 GPM max flow (stainless-steel)
- 7.8 GPM max flow (brass)
- 320°F max temperature (stainless-steel)
- 195°F max temperature (brass)
- Highly resistant to harsh chemicals
- "Live" swivel at full pressure
- 6 oz weight

Part No	Old No	Description	PSI
8.712-456.0	421030	Swivel, Stainless-Steel – 1/4" M x F	5600
8.712-455.0	421025	Swivel, Stainless-Steel – 3/8" M x F	5600
8.712-443.0	421009	Swivel, Brass – 3/8" M x F	3600
8.704-096.0	109542	Repair Kit for 8.712-456.0 and 8.712-455.0	

Gun Swivel



Made of corrosion-resistant material and stainless-steel, self-lubricated bearings, the new gun swivel offers highest-quality Swiss-made craftsmanship.



- 4000 PSI
- 250°F temperature
- 30 RPM

Part No	Old No	Description
8.712-467.0	421057	Gun Swivel DGV – 1/4" NPTF
8.712-466.0	421056	Gun Swivel DGV – 3/8" NPTF

Swivels



- Swivels even at 3000 PSI
- Brass housing
- Stainless-steel flow-through bolt
- Close-tolerance fit ensures leakproof seal
- Teflon® ring provides free swivel

Part No	Old No	Description
8.904-551.0	421010A	3/8" MPT x FPT*
8.904-552.0	421012A	3/8" FPT x FPT*
8.904-554.0	421015	3/8" FPT x FPT, Brass
8.900-764.0	109198	Seal Kit
8.900-765.0	109199	Rebuild Kit

*Long body style

Swivels - Stainless-Steel



- Swivels even at 4000 PSI
- 200°F max temperature
- All stainless construction
- Teflon® swivel ring
- Rebuildable
- 3/8" in and out

Part No	Old No	Description
8.712-446.0	421016	3/8" MPT x FPT
8.712-447.0	421017	3/8" FPT x FPT
8.900-764.0	109198	Seal Kit
8.900-765.0	109199	Rebuild Kit

COUPLERS, FITTINGS & FILTERS

Swivels – Ball Bearing

Swivels freely even at maximum pressure level noted below.

- MPT x FPT all sizes
- Brass and stainless-steel materials



8.712-438.0



8.712-479.0

Part No	Old No	Description	PSI
8.712-438.0	421004	1/4"	2000
8.712-439.0	421005	1/4"	3500
8.712-440.0	421006	3/8"	2000
8.712-441.0	421007	3/8"	3500
8.712-479.0	421080	1/4" 90°	3500
8.700-263.0	075060	Repair Kit	

Swivels – Stainless-Steel Ball Bearing

- Hardened, stainless-steel body
- Nitrile Buna seals
- 3500 PSI max pressure
- 180°F max temperature
- M x F NPT thread
- Ball-bearing design ensures free swivel action under pressure
- Suitable for extended-wear application



Part No	Old No	Description
8.712-457.0	421034	1/4", 6.8 GPM
8.700-460.0	076102	Repair Kit for 8.712-457.0
8.712-458.0	421036	3/8", 10.6 GPM
8.700-459.0	076101	Repair Kit for 8.712-458.0
8.712-459.0	421038	1/2", 27.0 GPM
8.700-461.0	076103	Repair Kit for 8.712-459.0

Adapters – Brass

Part No	Old No	FPT x MPT
8.705-186.0	140651	1/8" x 1/8"
9.803-054.0	140652	1/4" x 1/8"
8.705-188.0	140653	1/4" x 1/4"
8.705-185.0	140650	3/8" x 1/8"
9.804-007.0	140654	3/8" x 1/4"
8.705-190.0	140655	3/8" x 3/8"
8.705-192.0	140657	1/2" x 1/4"
8.705-191.0	140656	1/2" x 3/8"
9.802-148.0	140658	1/2" x 1/2"
8.705-194.0	140660	3/4" x 1/2"
8.705-195.0	140662	3/4" x 3/4"



Bushings – Brass

Part No	Old No	MPT X FPT
9.803-564.0	140402	1/4" x 1/8"
8.705-129.0	140404	3/8" x 1/4"
9.804-015.0		3/8" x 1/8"
9.802-135.0	140406	1/2" x 1/4"
8.705-132.0	140407	1/2" x 3/8"
8.705-133.0	140410	3/4" x 3/8"
9.802-136.0	140411	3/4" x 1/2"



Hex Couplings – Brass

Part No	Old No	FPT
8.705-150.0	140452	1/8"
8.705-151.0	140454	1/4"
8.705-152.0	140456	3/8"
8.705-153.0	140458	1/2"
8.705-154.0	140462	3/4"



Hex Couplings - Reducing – Brass

Part No	Old No	Description
8.705-155.0	140502	1/4" x 1/8" F
8.705-156.0	140504	3/8" x 1/4" F
8.705-157.0	140505	1/2" x 1/4" F
8.705-158.0	140506	1/2" x 3/8" F
8.705-159.0	140508	3/4" x 1/2" F



Hex Nipples – Double – Brass

Part No	Old No	Description
8.705-224.0	140752	1/8" x 1/8" M
9.802-108.0	140754	1/4" x 1/4" M
8.705-228.0	140756	3/8" x 3/8" M
9.803-989.0	140758	1/2" x 1/2" M
8.705-233.0	140762	3/4" x 3/4" M
8.705-234.0	140764	1" x 1" M



JIC Swivels

Part No	Description
9.802-153.0	1/4" Barb x 1/4" JIC FPT, Brass
9.802-151.0	1/2" Barb x 1/2" JIC FPT, Brass
9.802-152.0	3/4" Barb x 3/4" JIC FPT, Brass
9.802-048.0	1/2" JIC FPT x 3/8" MPT, Steel
8.706-315.0	1/2" JIC FPT x 1/2" MPT, Steel



9.802-151.0

Nipples – Brass

Part No	Old No	Description
8.705-201.0	2-1000	1/8" Close
8.705-204.0	2-1002	1/4" Close
8.705-211.0	2-1004	3/8" Close
9.802-109.0	2-1006	1/2" Close
8.705-220.0	2-1008	3/4" Close
8.705-202.0	140703	1/8" x 1-1/2"
8.705-203.0	140705	1/8" x 2-1/2"
8.705-205.0	140711	1/4" x 1-1/2"
8.705-206.0	140712	1/4" x 2"
8.705-207.0	2-1010	1/4" x 2-1/2"
8.705-212.0	140721	3/8" x 1-1/2"
8.705-213.0	140723	3/8" x 2-1/2"
8.705-214.0	2-10051	3/8" x 3"
8.705-217.0	140731	1/2" x 1-1/2"
8.705-218.0	140733	1/2" x 3"
8.705-221.0	140742	3/4" x 2"
8.705-222.0	140744	3/4" x 3"



Close



Nipple

Hex Reducing Nipples – Brass



Part No	Description
8.705-225.0	1/4" x 1/8"M
8.705-223.0	3/8" x 1/8"M
8.705-227.0	3/8" x 1/4"M

Part No	Description
8.705-229.0	1/2" x 1/4"M
9.803-276.0	1/2" x 3/8"M
9.803-556.0	3/4" x 1/2"M

Male Branch Tees – Brass



Part No	Description
9.802-120.0	1/4"
8.705-254.0	3/8"

Part No	Description
8.705-255.0	1/2"

Elbows – 90° – Brass

Part No	Old No	Description
8.705-160.0	140552	1/8" FPT
8.705-161.0	2-1018	1/4" FPT
9.802-113.0	2-1019	3/8" FPT
9.803-265.0	2-1020	1/2" FPT
8.705-164.0	2-1021	3/4" FPT
8.705-169.0	140584	1/4" x 1/4" MPT
8.705-171.0	140586	3/8" x 3/8" MPT
8.705-173.0	140588	1/2" x 1/2" MPT
9.802-129.0	2-1060	1/2" JIC x 3/8" MPT
9.802-031.0	2-1062	1/2" JIC x 1/2" MPT
Reducing Elbows		
8.705-165.0	2-10410	1/4" FPT x 1/8" FPT
8.705-166.0	140577	3/8" FPT x 1/4" FPT
8.705-168.0	140583	1/4" x 1/8" MPT
8.705-167.0	140582	3/8" x 1/8" MPT
8.705-170.0	140585	3/8" x 1/4" MPT
8.705-172.0	140587	1/2" x 3/8" MPT



Street Tees – Brass



Part No	Description
9.802-121.0	1/4"
8.705-257.0	3/8"

Part No	Description
9.802-122.0	1/2"
8.705-259.0	3/4"

Female Crosses – Brass Extruded



Part No	Description
8.705-196.0	1/4"
8.705-197.0	3/8"

Part No	Description
8.705-198.0	1/2"
8.705-199.0	3/4"

JIC x Pipe Nipples

Part No	Size
8.706-265.0	1/2" JIC x 1/4" FPT
9.802-037.0	1/2" JIC x 3/8" FPT
9.802-036.0	1/2" JIC x 3/8" MPT
9.802-038.0	1/2" JIC x 1/2" MPT



Check Hose Barbs

- 1/4" MPT x 1/4" barb
- Brass body
- Buna or Viton check ball



Part No	Old No	Description
8.904-389.0	385128	Check Hose Barb – Viton
8.904-390.0	385129	Check Hose Barb – Buna

Street Elbows – Brass



Part No	Description – 90°
8.705-174.0	1/8" M x F
9.803-839.0	1/4" M x F
9.802-114.0	3/8" M x F
9.802-115.0	1/2" M x F
9.803-555.0	3/4" M x F

Part No	Description – 45°
8.705-180.0	1/8" M x F
8.705-181.0	1/4" M x F
8.705-182.0	3/8" M x F
8.705-183.0	1/2" M x F
8.705-184.0	3/4" M x F

JIC Nipples – Brass



9.802-128.0



8.706-894.0

Part No	Description
8.706-872.0	1/2" JIC x 1/4" MPT
9.802-127.0	1/2" JIC x 3/8" MPT
9.802-128.0	1/2" JIC x 1/2" MPT
8.706-877.0	1/2" JIC x 3/4" MPT
8.706-894.0	1/2" JIC x 1/2" FPT
8.706-895.0	1/2" JIC x 3/8" FPT
8.706-896.0	1/2" JIC x 1/4" FPT
8.706-897.0	1/2" JIC x 3/4" FPT
8.706-899.0	3/4" JIC x 3/4" Pipe MPT
8.706-971.0	1/2" JIC x 3/4" GHF

Extruded or Forged Tees – Brass



Part No	Description
8.705-246.0	1/8" F
8.705-247.0	1/4" F
8.705-248.0	3/8" F

Part No	Description
9.802-117.0	1/2" F
8.705-251.0	3/4" F

COUPLERS, FITTINGS & FILTERS

Hose Barbs – Brass



90° Barb x MPT

Part No	Old No	Barb x MPT – 90°
9.802-142.0	140369	1/4" x 1/8"
9.802-143.0	140370	1/4" x 1/4"
8.705-118.0	140371	3/8" x 1/4"
8.705-119.0	140372	3/8" x 3/8"
8.705-120.0	140374	3/8" x 1/2"
8.705-121.0	140375	1/2" x 1/4"
8.705-122.0	140376	1/2" x 3/8"
8.705-123.0	140377	1/2" x 1/2"
8.705-125.0	140379	5/8" x 3/8"
8.705-126.0	140384	5/8" x 1/2"

Barb x MPT



Barb x MPT

8.705-097.0	140350	1/8" X 1/4"
9.802-137.0	140352	1/4" X 1/8"
9.802-138.0	140354	1/4" x 1/4"
8.705-102.0	140355	1/4" x 3/8"
8.705-108.0	140361	1/4" x 1/2"
8.705-098.0	140351	3/8" x 1/8"
8.705-104.0	140357	3/8" x 1/4"
8.705-105.0	140358	3/8" x 3/8"
8.705-103.0	140356	3/8" x 1/2"
8.705-100.0	140353	3/8" x 3/4"
8.705-110.0	140363	1/2" x 1/4"
8.705-106.0	140359	1/2" x 3/8"
8.705-109.0	140362	1/2" x 1/2"
8.705-111.0	140364	1/2" x 3/4"
8.705-107.0	140360	5/8" x 3/8"
9.802-140.0	140365	5/8" x 1/2"
8.705-113.0	140366	5/8" x 3/4"
8.705-114.0	140367	3/4" x 1/2"
8.705-115.0	140368	3/4" x 3/4"

Barb x FPT

8.706-949.0		1/4" X 1/4"
-------------	--	-------------

Push-N-Lock Barbs



Normally requires no clamps

Part No	Old No	Barb x MPT
8.705-069.0	140252	1/4" x 1/8"
8.705-070.0	140254	1/4" x 1/4"
8.705-071.0	140255	1/4" x 3/8"
8.705-072.0	140256	3/8" x 1/8"
8.705-073.0	140257	3/8" x 1/4"
8.705-074.0	140258	3/8" x 3/8"
8.705-075.0	140259	3/8" x 1/2"
8.705-076.0	140260	3/8" x 3/4"
8.705-077.0	140261	1/2" x 1/4"
9.802-156.0	140262	1/2" x 3/8"
8.705-079.0	140263	1/2" x 1/2"
8.705-080.0	140264	1/2" x 3/4"
8.705-081.0	140265	5/8" x 3/8"
8.705-082.0	140266	5/8" x 1/2"
8.705-083.0	140267	5/8" x 3/4"
8.705-084.0	140268	3/4" x 1/2"
8.705-085.0	140269	3/4" x 3/4"

Barb x Barb

8.705-064.0	140200	1/4" x 1/4"
8.705-065.0	140204	3/8" x 3/8"
8.705-066.0	140208	1/2" x 1/2"
8.705-067.0	140210	5/8" x 5/8"
8.705-068.0	140212	3/4" x 3/4"

Barb x Barb

Swivel Hose Barbs – Low Pressure

- 300 PSI max pressure
- 210°F max temperature
- Brass MPT base with steel hose barb
- Swivel easily at low pressure to eliminate twists and tangles in chemical or water lines



Part No	Old No	Description
8.705-050.0	140079	1/4" x 1/4"
8.705-052.0	140081	3/8" x 3/8"
8.705-053.0	140083	1/2" x 1/2"

Orificed Hose Barb

- Inexpensive way to create suction on inlet side of pump
- Used in-line from float tank to pump
- One-piece, machined-brass
- 3/8" MPT x 5/8" barb
- Standard orifice 5/32" — drill up to 3/8" to fit your need



Part No	Old No	Description
8.705-093.0	140320	Orificed Hose barb

Drain Cocks



Part No	Old No	Description
8.705-060.0	140125	1/4" Fuel Drain w/ Tee Handle
8.705-061.0	140127	1/4" Fuel Drain w/ Barb and Tee Handle

Hex Head Plugs



Part No	Old No	Description
8.705-236.0	140802	1/8"
8.705-238.0	140804	1/4"
8.705-240.0	140806	3/8"
9.803-673.0	140808	1/2"
8.705-244.0	140810	3/4"

Hex Socket Head Plugs



Part No	Old No	Description
9.803-051.0	140802A	1/8"
9.802-124.0	140804A	1/4"
8.705-241.0	140806A	3/8"
8.705-243.0	140808A	1/2"

Pipe Thread Hex Nuts



Part No	Old No	Description
8.705-041.0	140062	1/8"
8.705-042.0	140064	1/4"
8.705-043.0	140065	3/8"
8.705-044.0	140067	1/2"
8.705-045.0	140070	3/4"

Garden Hose Fittings

- MGH = male garden hose
- FGH = female garden hose
- Heavy-duty, machined-brass fittings



8.901-292.0



8.705-034.0



8.709-460.0



9.804-016.0



9.802-145.0



8.705-087.0

Part No	Old No	Description
Swivel Fittings – 3/4" FGH		
8.705-032.0	140050	1/4" MPT
8.901-292.0	140056	3/8" MPT
8.901-291.0	140051	1/2" MPT
8.705-033.0	140052	1/2" FPT (S-1)
9.802-146.0		3/4 FGH Swivel w/ 1/2" MPT Strainer
8.705-034.0	140054	3/4" FPT (S-2)
8.705-035.0	140055	3/4" FGH (S-3)
8.705-008.0	140002	1/2" Barb
8.705-009.0	140004	5/8" Barb
8.705-010.0	140006	3/4" Barb
Garden Hose Quick Couplers		
8.709-460.0	331040	Female Hose Coupler
8.709-508.0	331140	Male Hose Plug
Garden Hose Accessories		
8.705-016.0	140020	Garden Hose Washer
9.804-016.0	140015	Filter Screen Washer (30-mesh)
Solid Fittings		
8.705-024.0	140036	3/4" MGH x 3/8" MPT
9.802-145.0	140038	3/4" MGH x 1/2" MPT
8.705-026.0	140040	3/4" MGH x 3/4" MPT
8.705-019.0	140028	3/4" FGH x 1/2" FPT
8.705-020.0	140030	3/4" FGH x 3/4" FPT
8.705-022.0	140032	3/4" FGH x 1/2" MPT
8.705-023.0	140034	3/4" FGH x 3/4" MPT
8.705-018.0	140026	3/4" FGH x 3/4" FGH (Stainless-Steel)
Hose Barb Fittings		
8.705-086.0	140301	3/8" Barb x 3/4" MGH
8.705-087.0	140303	1/2" Barb x 3/4" MGH
8.705-088.0	140305	5/8" Barb x 3/4" MGH
8.705-089.0	140307	3/4" Barb x 3/4" MGH
8.705-091.0	140317	3/8" Barb x 3/4" FGH
8.705-092.0	140319	1/2" Barb x 3/4" FGH
8.705-094.0	140321	5/8" Barb x 3/4" FGH
8.705-095.0	140323	3/4" Barb x 3/4" FGH

Hose Clamps

WARNING: LOW-PRESSURE USE ONLY!
Not for use on pressure washer discharge hose.



- Stainless-steel band and housing
- Worm gear tensions



- Nylon "Speedi-Clamp" tightens with a snap
- Releases with a twist

Part No	Old No	Band	OD	Min-Max
9.802-200.0	358010	4mm	5/16"	.25-.63
8.710-456.0	358012	5mm	5/16"	.38-.88
8.710-457.0	358013	10mm	5/16"	.50-1.06
8.710-458.0	358015	H8	1/2"	.44-.91
8.710-459.0	358018	H10	1/2"	.56-1.06
8.710-460.0	358019	H12	1/2"	.69-1.25
8.710-461.0	358020	H16	1/2"	.75-1.50
8.710-464.0	358024	H32	1/2"	1.56 - 2.50
6.380-126.0		Red Spring Clamp		.466-.54
8.709-116.0		Green Spring Clamp		.40-.48
8.904-167.0*	358001X	1/4" ID Speedi-Clamp		
8.904-168.0*	358004X	3/8" ID Speedi-Clamp		
8.904-169.0*	358006X	1/2" ID Speedi-Clamp		

*50/pk

Zinc-plated Heavy Wall Steel Pipe Fittings

- Up to 6000 PSI working pressure (18,000 PSI burst)
- Attractive zinc-plated protective coating
- U.S.-standard taper pipe threads

Adapters – Steel



Part No	Old No	MPT x FPT	Working Pressure
8.705-356.0	142404	1/4" x 1/4"	6000
8.705-357.0	142405	1/4" x 3/8"	6000
9.804-553.0	142406	3/8" x 3/8"	6000
8.705-359.0	142407	3/8" x 1/2"	5000
8.705-360.0	142408	1/2" x 1/2"	5000
8.705-361.0	142409	1/2" x 3/4"	4000
8.705-362.0	142412	3/4" x 3/4"	4000

COUPLERS, FITTINGS & FILTERS

Hex Coupling – Steel



Part No	Old No	FPT x FPT	Working Pressure
8.705-364.0	142415	1/4" x 1/4"	6000
8.705-366.0	142417	3/8" x 3/8"	6000
8.705-369.0	142420	1/2" x 1/2"	5000
8.705-371.0	142422	3/4" x 3/4"	5000
Reducing Couplings			
8.705-365.0	142416	3/8" x 1/4"	6000
8.705-367.0	142418	1/2" x 3/8"	5000
8.705-368.0	142419	1/2" x 1/4"	5000
8.705-370.0	142421	3/4" x 1/2"	4000

Hex Nipple – Steel



Part No	Old No	FPT x FPT	Working Pressure
9.802-010.0	142425	1/4" x 1/4"	6000
9.802-011.0	142427	3/8" x 3/8"	6000
9.802-012.0	142430	1/2" x 1/2"	6000
8.705-380.0	142434	3/4" x 3/4"	6000
9.802-022.0	142426	3/8" x 1/4"	6000
8.705-375.0	142428	1/2" x 1/4"	6000
8.705-376.0	142429	1/2" x 3/8"	6000
8.705-379.0	142431	3/4" x 1/2"	6000

Street Elbow – Steel



Part No	Old No	MPT x FPT	Working Pressure
9.802-029.0	142438	1/4" x 1/4"	5000
9.804-080.0	142439	1/4" x 3/8"	4500
9.802-030.0	142440	3/8" x 3/8"	4500
8.705-384.0	142441	3/8" x 1/2"	3000
9.803-045.0	142442	1/2" x 1/2"	3000
8.705-386.0	142443	1/2" x 3/4"	3000
8.705-387.0	142444	3/4" x 3/4"	3000

Elbows - 45°



Part No	FPT x FPT
8.706-278.0	3/8" x 3/8"
8.706-277.0	1/4" x 1/4"

Street Tee – Steel



Part No	Old No	FPT x MPT	Working Pressure
8.705-428.0	142684	1/4"	5000
9.802-033.0	142685	3/8"	4500
9.802-034.0	142686	1/2"	3000
8.705-431.0	142687	3/4"	3000

Elbow – Steel



Part No	Old No	FPT x FPT	Working Pressure
8.706-176.0		1/4" x 1/8"	4500
8.705-393.0	142504	1/4" x 1/4"	5000
8.705-394.0	142505	1/4" x 3/8"	4500
9.802-023.0	142506	3/8" x 3/8"	4500
8.705-396.0	142507	3/8" x 1/2"	3000
8.705-397.0	142508	1/2" x 1/2"	3000
8.705-398.0	142509	1/2" x 3/4"	4000
8.705-399.0	142512	3/4" x 3/4"	4000

Part No	Old No	Description	Working Pressure
9.802-039.0	2-0053	1/2" JIC x 3/8" MPT	5000
9.802-040.0		1/2" JIC x 1/2" MPT	5000
9.802-130.0		1/2" JIC x 1/4" MPT	5000
8.706-906.0		1/2" JIC x 3/4" FPT	5000

Tee – 3 Connects



Part No	Old No	FPT	Working Pressure
8.705-412.0	142654	1/4"	5000
8.705-414.0	142656	3/8"	4500
9.802-032.0	142658	1/2"	3000
8.705-417.0	142662	3/4"	3000

Part No	MPT
8.706-213.0	1/4"

Cross – 4 Connects



Part No	Old No	FPT	Working Pressure
8.705-418.0	142664	1/4"	5000
8.705-419.0	142666	3/8"	4500
8.705-420.0	142668	1/2"	3000
8.705-421.0	142672	3/4"	3000

Reducing Bushing – Steel



Part No	Old No	MPT x FPT	Working Pressure
9.802-046.0	142676	3/8" x 1/4"	6000
8.705-423.0	142678	1/2" x 1/4"	6000
9.802-045.0	142680	1/2" x 3/8"	6000
8.705-426.0	142682	3/4" x 1/2"	6000

Pipe Street Elbows



Part No	Old No	MPT x FPT
8.705-407.0	142604	1/4"
8.705-408.0	142606	3/8"
8.705-409.0	142608	1/2"
8.705-410.0	142610	3/4"

Hex Pipe Plugs – Steel



Part No	Old No	Description	Working Pressure
9.803-530.0	142701	1/4"	6000
8.705-433.0	142702	3/8"	6000
8.705-434.0	142703	1/2"	6000
8.705-435.0	142704	3/4"	6000

Pipe Tees



Part No	Old No	FPT x FPT x FPT
8.705-456.0	142854	1/4"
8.705-458.0	142856	3/8"
8.705-459.0	142858	1/2"
8.705-461.0	142868	3/4"

Pipe Nipple – Zinc



Part No	Old No	Length x MPT	Working Pressure
9.803-043.0	142800	2" x 1/4"	6000
8.705-441.0	142801	3" x 1/4"	6000
8.705-442.0	142802	4" x 1/4"	6000
8.705-443.0	142803	2" x 3/8"	6000
8.705-985.0	142804	3" x 3/8"	6000
8.705-445.0	142805	4" x 3/8"	6000
8.705-446.0	142806	2" x 1/2"	6000

Part No	Old No	Length x MPT	Working Pressure
9.802-014.0	142807	3" x 1/2"	6000
9.802-015.0	142808	4" x 1/2"	6000
8.705-996.0	142808T	5" x 1/2"	6000
8.705-450.0	142810	2" x 3/4"	6000
8.705-451.0	142811	3" x 3/4"	6000
8.705-452.0	142812	4" x 3/4"	6000
8.705-453.0	142813	6" x 3/4"	6000

Merchant Coupling



Part No	Old No	FPT x FPT
8.705-389.0	142454	1/4"
8.705-390.0	142456	3/8"
8.705-391.0	142458	1/2"

Banded Coupling



Part No	Old No	FPT x FPT
8.705-436.0	142754	1/4"
8.705-437.0	142756	3/8"
8.705-438.0	142758	1/2"
8.705-439.0	142760	3/4"

Galvanized Pipe Fittings

- Pressed-steel fittings — external galvanized for excellent chemical resistance
- Ideal for supply line (city water pressure) applications (working pressure rating 125 PSI)
- NOT recommended for high-pressure piping applications.

Elbows - 90°



Part No	Old No	FPT x FPT
8.705-403.0	142552	1/4"
8.705-404.0	142556	3/8"
8.705-405.0	142558	1/2"
8.705-406.0	142560	3/4"

Filter - "The Big One"



Larger, heavier, and with more filtering area than competitors' filters.

- Corrosion-resistant plastic
- Stepped 1/4" and 3/8" hose barb
- Weighted to hold on to bottom of tank



Part No	Old No	Description
8.709-938.0	340025	With Check Valve
8.709-939.0	340026	Without Check Valve

Chemical Filter - Brass



50-mesh, stainless-steel screen. Removable mesh for easy cleaning. Heavy-duty, one-piece brass body holds the filter on the bottom of tank.

- 1/4" hose barb
- Stainless-steel check ball



Part No	Old No	Description
9.803-672.0	340010X	With Check Valve
8.709-934.0	340012X	Without Check Valve

Chemical Strainer - Plastic

Polypropylene and brass construction.

- 7mm hose barb



Part No	Old No	Description
8.709-935.0	340014	w/ Check Valve
9.802-160.0	340015	w/o Check Valve

Chemical Line w/ Filter

- 6-foot long, 1/4" clear vinyl tubing



Part No	Old No	Description
8.903-991.0	340022X	Chemical Line/ Filter w/ Check Valve (Brass Filter)
8.903-993.0	340024X	Chemical Line/ Filter w/ Check Valve (Plastic Filter)
8.903-996.0	340027X	Chemical Line/ Filter w/o Check Valve (Plastic Filter)

Filters - Heavy-Duty In-Line

- 1/2" female x male
- 50-mesh screen
- 8 GPM max flow
- 145 PSI max pressure
- 140°F max temperature
- Unbreakable reinforced nylon cap



Part No	Old No	Description
8.709-974.0	342026	Filter
8.709-975.0	342027	With Auxiliary (bypass) Port
8.704-172.0	109941	Replacement Filter

In-Line Filter - Green-Cap



The Original Green-Cap!

- 6 GPM max flow
- 40-mesh stainless screen
- Diecast metal housing/ plastic cap
- 1/2" FPT inlet
- 1/2" MPT outlet
- Two 1/4" side ports
- 145 PSI max pressure



Part No	Old No	Description
8.709-961.0	342010	Green Cap Filter
8.701-383.0	083441	Replacement Screen
8.701-382.0	083439	Replacement Cap
8.702-034.0	083440	Replacement O-Ring

In-Line Filter - All Metal



- Die-cast aluminum body and cover
- Black anodized finish
- 38-mesh screen
- 170 PSI max pressure
- 195°F max temperature
- 6.6 GPM max flow
- 1/2" female x male



Part No	Old No	Description
8.709-976.0	342030	All Metal Line Filter
8.704-055.0	109343	Replacement Filter

Filters - Clear Bowl

- Low-profile style
- MPT inlet and outlet
- White nylon body
- Clear bowl
- Stainless-steel screen
- L: 3", W: 1-3/4", H: 2-3/8"



Part No	Old No	Description
8.709-962.0	342012	1/4", 40-Mesh Screen
8.709-963.0	342013	1/4", 80-Mesh Screen
8.709-964.0	342014	3/8", 40-Mesh Screen
8.709-965.0	342015	3/8", 80-Mesh Screen
8.709-966.0	342016	1/2", 40-Mesh Screen
8.709-967.0	342017	1/2", 80-Mesh Screen
8.700-563.0	078214	80-Mesh Replacement Scrn
8.700-564.0	078215	40-Mesh Replacement Scrn

In-Line Can-Type Filters and Parts

- 40- or 80-mesh filtration
- Heavy-duty molded plastic with stainless-steel screen
- Hanger tab standard on 3/8", 1/2" and 3/4"
- Choose black or clear filter cans



Part No	Old No	Description
40-Mesh Filters		
8.709-982.0	342105	Black, 3/8"
8.709-986.0	342110	Black, 1/2"
8.709-990.0	342115	Black, 3/4"
8.709-994.0	342120	Black, 1"
8.710-001.0	342150	Black, 1-1/4"
8.710-003.0	342155	Black, 1-1/2"
8.709-983.0	342106	Clear, 3/8"
8.709-987.0	342111	Clear, 1/2"
8.709-991.0	342116	Clear, 3/4"
8.709-996.0	342123	Clear, 1"
8.710-002.0	342151	Clear, 1-1/4"
8.710-004.0	342156	Clear, 1-1/2"

80-Mesh Filters		
8.709-988.0	342112	Black, 1/2"
8.709-992.0	342117	Black, 3/4"
8.709-995.0	342122	Black, 1"
8.710-005.0	342158	Black, 1-1/4"
8.709-999.0	342147	Black, 1-1/2"
8.709-989.0	342113	Clear, 1/2"
8.709-993.0	342118	Clear, 3/4"
8.709-997.0	342125	Clear, 1"
8.710-006.0	342159	Clear, 1-1/4"
8.710-000.0	342149	Clear, 1-1/2"

In-Line Can-Type Filter Parts – 3/8", 1/2", 3/4"		
8.700-555.0	078202	Gasket
8.700-557.0	078204	Viton Gasket
8.700-559.0	078207	Bowl – Standard Black
8.700-560.0	078208	Bowl – Clear
8.700-565.0	078216	40-Mesh Screen
8.700-567.0	078220	80-Mesh Screen
8.932-949.0	078223	3/8" Top with Tab
8.700-569.0	078224	1/2" Top with Tab
8.700-570.0	078225	3/4" Top with Tab

In-Line Can-Type Filter Parts – 1", 1-1/4", 1-1/2"		
8.700-556.0	078203	Gasket
8.700-558.0	078205	Viton Gasket
8.700-566.0	078217	40-Mesh Screen 1"
8.700-575.0	078233	40-Mesh Screen 1-1/4"
8.700-576.0	078234	40-Mesh Screen 1-1/2"
8.700-568.0	078221	80-Mesh Screen 1"
8.700-577.0	078237	80-Mesh Screen 1-1/4"
8.700-578.0	078238	80-Mesh Screen 1-1/2"
8.700-571.0	078226	1" Filter Top
8.700-572.0	078227	1-1/4" Filter Top
8.700-573.0	078230	Bowl Black – 1", 1-1/4", 1-1/2"
8.700-574.0	078231	Bowl Clear – 1", 1-1/4", 1-1/2"

In-Line ClearView Filter



- Stainless-steel screen
- Combination 1/2" / 3/4" hose barb
- Weighted to hold at bottom of tank or source

Part No	Old No	Description
8.710-145.0	347091	3/8" NPT x 3/4" GH
8.710-147.0	347093	3/8" NPT x 3/4" GH w/ 1/4" Bypass
8.710-144.0	347090	1/2" NPT x 3/4" GH
8.710-146.0	347092	1/2" NPT x 3/4" GH w/ 1/4" Bypass

Y-Trap Strainer



- Brass bodies and cap
- FPT inlet and outlet
- Stainless-steel 50-mesh cylinder screen
- 170 PSI max pressure
- 194°F max temperature



Part No	Old No	FPT
8.709-956.0	342004	1/4"
8.709-957.0	342006	3/8"
8.709-958.0	342007	1/2"
8.709-959.0	342008	3/4"
8.709-960.0	342009	1"

Check/Foot Valve

Includes backflow check and perforated screen, prevents damage to pump or control valves.

- Removable stainless-steel screen
- Spring-loaded check valve
- Cast-brass bodies
- FPT outlet



Part No	Old No	Description
8.709-388.0	310882	1/2" Foot Valve/ Check and Screen
8.709-389.0	310883	3/4" Brass Spring Check Valve
8.709-390.0	310884	1" Brass Spring Check Valve
8.709-391.0	310886	1-1/2" Brass Spring Check Valve
8.709-392.0	310888	2" Brass Spring Check Valve

Suction Foot Valve - ST35/35R

- Stainless-steel screen
- Combination 1/2" / 3/4" hose barb
- Weighted to hold at bottom of tank or source



Part No	Old No	Description
8.709-970.0	342021	With Check Valve
8.709-969.0	342020	Without Check Valve

COUPLERS, FITTINGS & FILTERS

Tank Screen/Strainer

- Stainless-steel screen — 40- or 50-mesh
- PVC base — attaches to nipple or tubing
- Use for tank drain or chemical line



Part No	Old No	Mesh	FPT
8.710-008.0	342304	50	1/4"
8.710-010.0	342306	50	3/8"
8.710-011.0	342307	40	1/2"
9.802-162.0	342308	50	1/2"
8.710-013.0	342311	40	3/4"
8.710-014.0	342312	50	3/4"
8.710-015.0	342316	40	1"
8.710-016.0	342320	40	1-1/2"

In-Line High-Pressure Nozzle Filters

Protect your turbo nozzle from damage caused by debris in the water flow.



8.709-978.0



8.710-149.0



8.709-979.0



8.710-150.0

- 1/4" MPT outlet
- 300°F max
- 100-mesh screen
- 5000 PSI max

Part No	Old No	Material	Inlet	Outlet
8.709-978.0	342040	Brass	1/4" FPT	1/4" MPT
8.709-979.0	342042	Brass	1/4" QC	1/4" MPT
8.710-149.0	347097	416 SS	1/4" QC	1/4" MPT
8.710-150.0	347098	Brass	1/4" MPT	1/4" MPT
8.704-234.0	110595	Replacement filter for 342040/342042		
8.701-201.0	080115	Replacement filter for 347097/347098		

Filter and Parts - High-Volume

Molded plastic housing.

- 3/4" FPT inlet and outlet
- 125 PSI max pressure
- 12 GPM max flow at 50 micron
- 10 GPM max flow at 5 or 20 micron
- Clear-view sump
- 14-1/2" tall x 5-1/2" port to port



Part No	Old No	Description
8.710-017.0	342375	Housing Only
8.905-569.0	565375X	Mounting Bracket/Hardware
8.700-581.0	078280	Replacement O-Ring

- Pleated polyester/polypropylene core
- Recommended for large flow, low-pressure applications (up to 60 PSI)



Part No	Old No	Description
Ultra Fine Filter Elements		
8.710-019.0	342380	5 Micron, 10 GPM
8.710-020.0	342382	20 Micron, 10 GPM
8.710-021.0	342384	50 Micron, 12 GPM

- Recommended for maximum filtration with reduced flow requirements (up to 130 PSI)



Part No	Old No	Description
Synthetic String Wound Elements		
8.710-022.0	342387	5 Micron, 4 GPM
8.710-023.0	342389	20 Micron, 5 GPM
8.710-024.0	342391	50 Micron, 6 GPM

Fuel Filters

In-line, disposable.



8.709-942.0



9.802-211.0

Part No	Old No	Description
9.802-211.0	341001	1/4" In/Out, Plastic
8.709-942.0	341002	1/4" In/Out, Metal
8.709-943.0	341003	3/8" In/Out, Plastic

Clear Bowl Fuel Filter

- Aluminum housing
- Non-replaceable 120-mesh stainless-steel screen
- 1/4" x 1/4"
- Clear acrylic bowl



Part No	Old No	Description
8.709-948.0	341013	Complete Unit

Fuel Filter / Water Separator



- 10 micron filtration
- Spin-on convenience
- Water-separation chamber
- 1/4" FPT inlet / outlet
- Easy drain water / sediment bowl



Part No	Description
8.725-306.0	Complete Unit
8.725-307.0*	Element Only

*Order 24 for a full case

Blue Top Filter



Part No	Description
8.753-559.0	Housing, 5" 1/2" F-F
8.753-561.0	Housing, 5", 1" F-F
8.753-562.0	Housing, 10", 1/2" F-F
8.753-563.0	Housing, 10", 3/4" F-F
8.753-564.0	Cartridge, 10" Poly Thread (Disposable)
8.753-565.0	Cartridge, 5" Poly Thread (Disposable)
8.753-566.0	Cartridge, 10" Nylon Mesh (Washable)
8.753-567.0	Cartridge, 5" Nylon Mesh (Washable)

Fuel Filter / Water Separator



The "Max" fuel system protector.

- 10 micron filtration
- Spin-on convenience
- Water-separation chamber
- 1/4" FPT inlet/outlet
- Easy-drain water/sediment bowl



Part No	Old No	Description
9.802-212.0	341040	Complete Unit
8.709-953.0	341042	Element
8.700-553.0	078127	Plastic Bowl

General Fuel Filter Element

- Can type
- 10 GPH max flow
- 10 micron filtration
- Inexpensive replacement
- Wool felt element



Part No	Old No	Description
8.709-950.0	341017	Element

Racor Filter Funnel



- 3.9 GPM
- Telfon-coated, stainless-steel filter
- Separates free water and contaminates from gasoline/diesel/kerosene



Part No	Old No	Description
8.709-955.0	341044	Racor Filter Funnel

NOZZLES

Nozzle Size Selection Chart

Determine the nozzle size by the pressure washer's GPM @ PSI (gallons per minute @ a specific pounds per square inch). If the nozzle size is too small, your equipment can be damaged. If the nozzle size is too large, cleaning ability is compromised. Nozzle fan degree does not effect nozzle size selection.

Standard Nozzle Size	Hole Size	Pounds Per Square Inch (PSI)																
		500	750	1000	1250	1500	1750	2000	2250	2500	2750	3000	3250	3500	3750	4000	4500	5000
2	.034"/0.86mm	0.71	0.87	1.00	1.12	1.22	1.32	1.41	1.50	1.58	1.66	1.73	1.80	1.87	1.94	2.00	2.12	2.24
2.5	.042"/1.07mm	0.88	1.08	1.25	1.40	1.53	1.65	1.77	1.88	1.98	2.07	2.17	2.25	2.34	2.42	2.50	2.65	2.80
3	.043"/1.09mm	1.06	1.30	1.50	1.68	1.84	1.98	2.12	2.25	2.37	2.49	2.60	2.70	2.81	2.90	3.00	3.18	3.35
3.5	.048"/1.22mm	1.24	1.52	1.75	1.96	2.14	2.32	2.47	2.63	2.77	2.90	3.03	3.15	3.27	3.39	3.50	3.71	3.91
4	.052"/1.32mm	1.41	1.73	2.00	2.24	2.45	2.65	2.83	3.00	3.16	3.32	3.46	3.61	3.74	3.87	4.00	4.24	4.47
4.5	.055"/1.40mm	1.59	1.95	2.25	2.52	2.76	2.98	3.18	3.38	3.56	3.73	3.90	4.06	4.21	4.36	4.50	4.77	5.03
5	.057"/1.45mm	1.77	2.17	2.50	2.80	3.06	3.31	3.54	3.75	3.95	4.15	4.33	4.51	4.68	4.84	5.00	5.30	5.59
5.5	.06"/1.52mm	1.94	2.38	2.75	3.07	3.37	3.64	3.89	4.13	4.35	4.56	4.76	4.96	5.14	5.33	5.50	5.83	6.15
6	.062"/1.57mm	2.12	2.60	3.00	3.35	3.67	3.97	4.24	4.50	4.74	4.97	5.20	5.41	5.61	5.81	6.00	6.36	6.71
6.5	.064"/1.63mm	2.30	2.81	3.25	3.63	3.98	4.30	4.60	4.88	5.14	5.39	5.63	5.86	6.08	6.29	6.50	6.89	7.27
7	.067"/1.70mm	2.47	3.03	3.50	3.91	4.29	4.63	4.95	5.25	5.53	5.80	6.06	6.31	6.55	6.78	7.00	7.42	7.83
7.5	.070"/1.78mm	2.65	3.25	3.75	4.19	4.59	4.96	5.30	5.63	5.93	6.22	6.50	6.76	7.02	7.26	7.50	7.95	8.39
8	.072"/1.83mm	2.83	3.46	4.00	4.47	4.90	5.29	5.66	6.00	6.32	6.63	6.93	7.21	7.48	7.75	8.00	8.49	8.94
8.5	.074"/1.88mm	3.01	3.68	4.25	4.75	5.21	5.62	6.01	6.38	6.72	7.05	7.36	7.66	7.95	8.23	8.50	9.02	9.50
9	.076"/1.93mm	3.18	3.90	4.50	5.03	5.51	5.95	6.36	6.75	7.12	7.46	7.79	8.11	8.42	8.71	9.00	9.55	10.06
9.5	.078"/1.98mm	3.36	4.11	4.75	5.31	5.82	6.28	6.72	7.13	7.51	7.88	8.23	8.56	8.89	9.20	9.50	10.08	10.62
10	.080"/2.03mm	3.54	4.33	5.00	5.59	6.12	6.61	7.07	7.50	7.91	8.29	8.66	9.01	9.35	9.68	10.00	10.61	11.18
11	.083"/2.11mm	3.89	4.76	5.50	6.15	6.74	7.28	7.78	8.25	8.70	9.12	9.53	9.92	10.29	10.65	11.00	11.67	12.30
12	.087"/2.21mm	4.24	5.20	6.00	6.71	7.35	7.94	8.49	9.00	9.49	9.95	10.39	10.82	11.22	11.62	12.00	12.73	13.42
12.5	.089"/2.26mm	4.42	5.41	6.25	6.99	7.65	8.27	8.84	9.38	9.88	10.36	10.83	11.27	11.69	12.10	12.50	13.26	13.98
13	.091"/2.31mm	4.60	5.63	6.50	7.27	7.96	8.60	9.19	9.75	10.28	10.78	11.26	11.72	12.16	12.59	13.00	13.79	14.53
15	.096"/2.44mm	5.30	6.50	7.50	8.39	9.19	9.92	10.61	11.25	11.86	12.44	12.99	13.52	14.03	14.52	15.00	15.91	16.77
20	.109"/2.77mm	7.07	8.66	10.00	11.18	12.25	13.23	14.14	15.00	15.81	16.58	17.32	18.03	18.71	19.36	20.00	21.21	22.36
25	.125"/3.18mm	8.84	10.83	12.50	13.98	15.31	16.54	17.68	18.75	19.76	20.73	21.65	22.53	23.39	24.21	25.00	26.52	27.95
30	.141"/3.58mm	10.61	12.99	15.00	16.77	18.37	19.84	21.21	22.50	23.72	24.87	25.98	27.04	28.06	29.05	30.00	31.82	33.54
40	.156"/3.96mm	14.14	17.32	20.00	22.36	24.49	26.48	28.28	30.00	31.62	33.17	34.64	36.06	37.42	38.73	40.00	42.43	44.72
50	.172"/4.37mm	17.68	21.65	25.00	27.95	30.62	33.07	35.36	37.50	39.53	41.46	43.30	45.07	46.77	48.41	50.00	53.03	55.90
60	.188"/4.78mm	21.21	25.98	30.00	33.54	36.74	39.69	42.43	45.00	47.43	49.75	51.96	54.08	56.12	58.09	60.00	63.64	67.08

Nozzle Fan Selection

Select the nozzle degree or spray angle, based on your application. Standard nozzle degrees — 0°, 15°, 25°, and 40°. Using the wrong nozzle degree can damage the surface you are cleaning.

0° - Red:

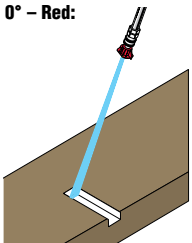

■ Cutting nozzle. It delivers a concentrated stream that can gouge or cut. It can cut stubborn stains from concrete and other hard surfaces.

15° - Yellow:

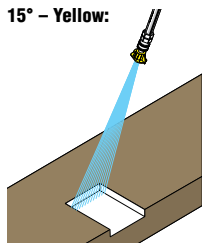

■ Chiseling nozzle. Working at a 45° angle, this nozzle works like a scraper, stripping paint, grease and grime from hard surfaces.

25° - Green:

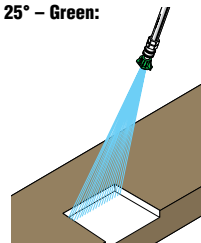

■ Flushing nozzle. The most commonly used nozzle for cleaning dirt from siding, sidewalks and metal furniture as well as for wet sweeping leaves.

40° - White:

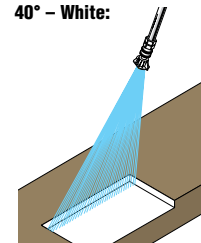

■ Wash nozzle. Its wide spray allows you to wash and rinse a large area fast. It is usually safe with most surfaces, including aluminum siding, windows and vehicles.

Nozzle Kits - Legacy 4/pk and 5/pk Color-Coded QC



1/4" Quick Coupler Nozzle Kits

- Hardened stainless-steel one-piece body for long life
- High-impact, uniform, flat-spray pattern
- Color-coded by spray angle
- Includes 40 x 65 soap nozzle

Made in USA



4/pk (0°, 25°, 40°, and Soap)

Part No	Nozzle Size
8.726-117.0	3.0
9.104-028.0	3.25
8.726-119.0	3.5
8.726-120.0	4.0
8.726-121.0	4.5
8.726-122.0	5.0
8.726-123.0	5.5
8.726-124.0	6.0
8.726-125.0	6.5



5/pk (0°, 15°, 25°, 40°, and Soap)

Part No	Nozzle Size
9.104-024.0	3.0
9.104-016.0	3.25
8.726-128.0	3.5
9.104-030.0	4.0
8.726-130.0	4.5
8.726-131.0	5.0
8.726-132.0	5.5
8.726-133.0	6.0
8.726-134.0	6.5

Nozzles - Legacy Individual 1/4" QC



"QC", Color-coded, hardened stainless nozzle, fits most 1/4" quick couplers. Rated for 4000 PSI.

Made in USA



QC Nozzles

Orifice	Part No. 0°	Part No. 15°	Part No. 25°	Part No. 40° (White)
	Red	Yellow	Green	White
3.0	8.723-576.0	8.902-482.0	8.902-484.0	8.902-485.0
3.25	8.708-538.0	8.708-539.0	8.708-540.0	8.708-541.0
3.5	8.723-577.0	8.726-104.0	8.708-526.0	8.902-487.0
3.75	8.708-527.0	8.708-528.0	8.708-529.0	8.708-530.0
4.0	8.708-531.0	8.708-532.0	8.708-533.0	8.708-534.0
4.5	8.723-578.0	8.708-535.0	8.708-536.0	8.708-537.0
5.0	8.726-105.0	8.726-106.0	8.726-107.0	8.726-108.0
5.5	8.723-579.0	8.902-492.0	8.708-542.0	8.902-493.0
6.0	8.726-109.0	8.726-110.0	8.726-111.0	8.726-112.0
6.5	8.726-113.0	8.726-114.0	8.726-115.0	8.726-116.0



QC Soap Nozzle

Part No	Orifice	Degree
8.723-636.0	40	65°

NOZZLES

Nozzle Sets - 4/pk and 5/pk Color-Coded QC



Nozzle sets contain a complete set of four quick coupler nozzles at 0°, 15°, 25°, and 40°. The 5/pk includes one 40 x 65° soap nozzle.



4/pk

Part No	Old No	Nozzle Size
8.708-712.0	259700	3.5
8.708-713.0	259701	4.0
8.708-714.0	259702	4.5
8.708-715.0	259703	5.0
8.708-716.0	259704	5.5
8.708-717.0	259705	6.0
8.708-718.0	259706	6.5

5/pk

Part No	Old No	Nozzle Size
9.104-014.0	259710	3.5
8.708-721.0	259711	4.0
9.104-015.0	259712	4.5
8.708-723.0	259713	5.0
8.708-724.0	259714	5.5
8.708-725.0	259715	6.0
8.708-726.0	259716	6.5

Nozzles - General Pump



These quick-coupled, color-coded, hardened stainless nozzles fit most 1/4" quick couplers. Rated for 4000 PSI.



Q-Style Nozzle

Orifice	0° Part No	Old No	15° Part No	Old No	25° Part No	Old No	40° Part No	Old No
2.0	-	-	8.712-322.0	-	8.708-645.0	-	8.708-652.0	-
2.5	8.708-647.0	-	8.708-648.0	-	8.708-649.0	-	8.708-651.0	-
3.0	9.802-287.0	259610	9.802-288.0	259611	9.802-289.0	259612	8.932-998.0	259613
3.5	9.802-291.0	259615	9.802-292.0	259616	9.802-293.0	259617	9.802-294.0	259618
4.0	9.802-295.0	259620	9.802-296.0	259621	9.802-297.0	259622	9.802-298.0	259623
4.5	9.803-810.0	259625	9.803-811.0	259626	9.803-812.0	259627	9.803-813.0	259628
5.0	9.802-299.0	259630	9.802-300.0	259631	9.802-301.0	259632	9.802-302.0	259633
5.5	9.802-303.0	259635	9.802-304.0	259636	9.802-305.0	259637	9.802-306.0	259638
6.0	9.802-307.0	259640	9.802-308.0	259641	9.802-309.0	259642	9.802-310.0	259643
6.5	8.708-681.0	259645	8.708-682.0	259646	8.708-683.0	259647	8.708-684.0	259648
7.0	9.803-800.0	259650	9.803-801.0	259651	9.803-802.0	259652	9.803-803.0	259653
7.5	8.708-689.0	259655	8.708-690.0	259656	8.708-691.0	259657	8.708-692.0	259658
8.0	8.708-693.0	259660	8.708-694.0	259661	8.708-695.0	259662	8.708-696.0	259663
8.5	8.708-697.0	259665	8.708-698.0	259666	8.708-699.0	259667	8.708-700.0	259668
9.0	8.708-701.0	259670	8.708-702.0	259671	8.708-703.0	259672	8.708-704.0	259673
10.0	8.708-705.0	259675	8.708-706.0	259676	8.708-707.0	259677	8.708-708.0	259678



M-Style 1/4" Male Threads

- 1/4" male pipe thread nozzles, rated up to 5000 PSI. Hardened stainless-steel nozzle insert ensures consistent, accurate orifice size.
- GP M-Style 2.5 x 4.0

Orifice	0° Part No	Old No	15° Part No	Old No	25° Part No	Old No	40° Part No	Old No
2.5	-	-	8.708-569.0	-	8.708-650.0	-	8.708-570.0	-
3.0	8.708-572.0	259100	8.708-574.0	259101	8.708-573.0	259102	8.708-575.0	259103
3.5	8.708-576.0	259104	8.708-578.0	259105	8.708-577.0	259106	8.708-579.0	259107
4.0	8.708-580.0	259108	8.708-582.0	259109	8.708-581.0	259110	8.708-583.0	259111
4.5	8.708-584.0	259112	8.708-586.0	259113	8.708-585.0	259114	8.708-587.0	259115
5.0	8.708-588.0	259116	8.708-590.0	259117	8.708-589.0	259118	8.708-591.0	259119
5.5	8.708-592.0	259120	8.708-594.0	259121	8.708-593.0	259122	8.708-595.0	259123
6.0	8.708-596.0	259125	8.708-598.0	259126	8.708-597.0	259127	8.708-599.0	259128
6.5	8.708-600.0	259130	8.708-602.0	259131	8.708-601.0	259132	8.708-603.0	259133
7.0	8.708-604.0	259135	8.708-606.0	259136	8.708-605.0	259137	8.708-607.0	259138
7.5	8.708-608.0	259140	8.708-610.0	259141	8.708-609.0	259142	8.708-611.0	259143
8.0	8.708-612.0	259145	8.708-614.0	259146	8.708-613.0	259147	8.708-615.0	259148
8.5	8.708-616.0	259150	8.708-618.0	259151	8.708-617.0	259152	8.708-619.0	259153
9.0	8.708-620.0	259155	8.708-622.0	259156	8.708-621.0	259157	8.708-623.0	259158
10.0	8.708-624.0	259160	8.708-626.0	259161	8.708-625.0	259162	8.708-627.0	259163



Q-Style Chemical Nozzle

- Q-Style Chemical Nozzles, are brass with a large #40 orifice and 65° spray angle. Ideal for low-pressure chemical applications.

Part No	Old No	Orifice	Degree
9.802-311.0	259690	40	65°
8.708-711.0	259695	50	15°



Nozzle Holder Grommet

Part No	Old No	Description
8.710-343.0	349917	Grommets -7/16" x 15/16" x 3/8"

Nozzles - Spraying Systems

1/4" male pipe thread meg nozzles, rated up to 4000 PSI. Hardened stainless-steel nozzle ensures consistent, accurate orifice size.



1/4" Male Threads

- Orifice recessed for protection
- 4000 PSI rated working pressure
- ± 2% flow tolerance @ 70°F
- Hard-edge pattern, light center requires overlap to cover center

Orifice	0° Part No	Old No	15° Part No	Old No	25° Part No	Old No	40° Part No	Old No
2.0	8.707-637.0	251100	8.707-640.0	251105	8.707-643.0	251110	8.707-648.0	251115
2.5	8.707-646.0	251113	8.707-650.0	251116	8.707-653.0	251119	-	-
3.0	8.707-655.0	251120	8.707-657.0	251125	8.707-659.0	251130	8.707-661.0	251135
3.5	8.707-662.0	251140	8.707-664.0	251145	8.707-666.0	251150	8.707-667.0	251155
4.0	8.707-669.0	251160	8.707-671.0	251161	8.707-673.0	251165	8.707-675.0	251170
4.5	8.707-678.0	251175	8.707-679.0	251180	8.707-680.0	251185	8.707-681.0	251190
5.0	8.707-683.0	251195	8.707-686.0	251200	8.707-688.0	251205	8.707-691.0	251210
5.5	8.707-694.0	251215	8.707-695.0	251220	8.707-697.0	251225	8.707-698.0	251230
6.0	8.707-700.0	251235	8.707-702.0	251240	8.707-703.0	251245	8.707-705.0	251250
6.5	8.707-708.0	251255	8.707-710.0	251260	8.707-711.0	251265	8.707-712.0	251270
7.0	8.707-713.0	251275	8.707-715.0	251280	8.707-716.0	251285	8.707-717.0	251290
7.5	8.707-718.0	251300	8.707-719.0	251305	8.707-721.0	251310	8.707-722.0	251315
8.0	8.707-723.0	251320	8.707-726.0	251325	8.707-727.0	251330	8.707-729.0	251335
8.5	8.707-734.0	251340	8.707-735.0	251345	8.707-736.0	251350	8.707-738.0	251355
9.0	8.707-739.0	251360	8.707-741.0	251365	8.707-743.0	251370	8.707-746.0	251375
10.0	8.707-747.0	251380	8.707-751.0	251385	8.707-754.0	251390	8.707-756.0	251395
11.0	8.707-760.0	251400	8.707-761.0	251405	8.707-762.0	251410	8.707-763.0	251415
12.0	8.707-764.0	251420	8.707-766.0	251425	8.707-767.0	251430	8.707-768.0	251435
12.5	8.707-769.0	251440	8.707-770.0	251445	8.707-771.0	251450	8.707-772.0	251455
13.0	8.707-773.0	251460	8.707-774.0	251465	8.707-776.0	251470	8.707-778.0	251475
15.0	8.707-782.0	251480	8.707-787.0	251485	8.707-789.0	251490	8.707-790.0	251495
20.0	8.707-795.0	251500	8.707-800.0	251505	8.707-802.0	251510	8.707-804.0	251515
25.0	8.707-807.0	251520	8.707-811.0	251525	8.707-812.0	251530	8.707-813.0	251535
30.0	8.707-814.0	251540	8.707-817.0	251545	8.707-818.0	251550	8.707-819.0	251555
40.0	8.707-821.0	251560	8.707-824.0	251565	8.707-826.0	251570	8.707-827.0	251575
50.0	8.707-828.0	251580	8.707-830.0	251585	8.707-832.0	251590	8.707-833.0	251595
60.0	8.707-834.0	251600	8.707-835.0	251605	8.707-837.0	251610	8.707-838.0	251615

1/8" male pipe thread meg nozzles, rated up to 4000 PSI. Hardened stainless-steel nozzle ensures consistent, accurate orifice size.



1/8" Male Threads

- Orifice recessed for protection
- 4000 PSI rated working pressure
- ± 2% flow tolerance @ 70°F
- Hard-edge pattern, light center requires overlap to cover center

Orifice	0° Part No	Old No	15° Part No	Old No	25° Part No	Old No	40° Part No	Old No
2.0	8.707-529.0	250100	8.707-536.0	250105	8.707-537.0	250110	8.707-538.0	250115
2.5	-	-	-	-	8.711-465.0	-	-	-
3.0	8.707-540.0	250120	8.707-542.0	250125	8.707-543.0	250130	8.707-544.0	250135
3.5	-	-	8.707-545.0	250137	8.707-546.0	250138	-	-
4.0	8.707-547.0	250140	8.707-549.0	250145	8.707-550.0	250150	8.707-551.0	250155
4.5	8.707-552.0	250160	8.707-554.0	250165	8.707-556.0	250170	8.707-557.0	250175
5.0	8.707-558.0	250180	8.707-559.0	250185	8.707-561.0	250190	8.707-564.0	250195
5.5	8.707-567.0	250200	8.707-568.0	250205	8.707-569.0	250210	8.707-570.0	250215
6.0	8.707-571.0	250220	8.707-572.0	250225	8.707-573.0	250230	8.707-575.0	250235
6.5	8.707-577.0	250240	8.707-578.0	250245	8.707-579.0	250250	8.707-581.0	250255
7.0	8.707-582.0	250260	8.707-584.0	250265	8.707-585.0	250270	8.707-586.0	250275
7.5	8.707-588.0	250280	8.707-589.0	250285	8.707-591.0	250290	8.707-592.0	250295
8.0	8.707-593.0	250300	8.707-594.0	250305	8.707-595.0	250310	8.707-596.0	250315
8.5	8.707-598.0	250320	8.707-599.0	250325	8.707-600.0	250330	8.707-601.0	250335
9.0	8.707-602.0	250340	8.707-604.0	250345	8.707-605.0	250350	8.707-607.0	250355
9.5	-	-	8.707-609.0	250365	8.707-610.0	250370	8.707-611.0	250375
10.0	8.707-612.0	250380	8.707-613.0	250385	8.707-614.0	250390	8.707-616.0	250395
11.0	8.707-618.0	250400	8.707-619.0	250405	8.707-620.0	250410	-	-
12.0	8.707-621.0	250420	-	-	-	-	8.707-623.0	250435
15.0	8.707-625.0	250440	8.707-626.0	250445	8.707-627.0	250450	-	-
20.0	8.707-628.0	250500	-	-	-	-	-	-

NOZZLES

Nozzles - Spraying Systems

“QC” or Quick Connect Hardened Stainless Meg Nozzle, fits most 1/4” quick couplers. Rated for 4000 PSI.

- 4000 PSI
- Flow-rated tolerance of ±2%
- Hardened stainless-steel
- 300°F
- Fits Hansen and Parker quick-couplers

QC “Wash Jet”
Nozzle with Color-
coded Nozzle
Protector



Orifice	0° P/N	Old P/N	15° P/N	Old P/N	25° P/N	Old P/N	40° P/N	Old P/N
	Red		Yellow		Green		White	
3.0	8.708-417.0	255120	8.708-418.0	4-12803015S	8.708-419.0	255140	8.708-420.0	4-12803040S
3.5	8.708-422.0	4-12803500S	8.708-423.0	4-12803515S	8.708-424.0	4-12803525S	8.708-425.0	4-12803540S
4.0	8.708-427.0	255160	8.708-428.0	255161	8.708-429.0	255165	8.708-430.0	255170
4.5	8.708-431.0	255175	8.708-432.0	255180	8.708-433.0	255185	8.708-434.0	255190
5.0	8.708-435.0	255195	8.708-436.0	255200	8.708-437.0	255205	8.708-438.0	255210
5.5	8.708-439.0	255215	8.708-440.0	255220	8.708-441.0	255225	8.708-442.0	255230
6.0	8.708-443.0	255235	8.708-444.0	255240	8.708-445.0	255245	8.708-446.0	255250
6.5	8.708-447.0	255255	8.708-448.0	255260	8.708-449.0	255265	8.708-450.0	255270
7.0	8.708-451.0	255275	8.708-452.0	255280	8.708-453.0	255285	8.708-454.0	255290
7.5	8.708-455.0	255300	8.708-456.0	255305	8.708-457.0	255310	8.708-458.0	255315
8.0	8.708-459.0	255320	8.708-460.0	255325	8.708-461.0	255330	8.708-462.0	255335
9.0	–	–	8.708-463.0	255365	8.708-464.0	255370	8.708-465.0	255375
10.0	8.708-467.0	255380	8.708-468.0	255385	8.708-469.0	255390	8.708-470.0	255395
12.0	8.708-471.0	255420	8.708-472.0	255425	–	–	8.708-474.0	255435

Nozzles for Low-Pressure Applications, Brass

1/4" male pipe thread Vee Jet nozzles, brass inexpensive alter-tive for applications up to 500 PSI.

- Feather edge for wide coverage
- Excellent for low-pressure chemical and acid applications
- Allows overlap for even application
- 1/4" MPT connects



1/4" Male Threads

Nozzle Size	0° P/N	Old P/N	15° P/N	Old P/N	25° P/N	Old P/N	40° P/N	Old P/N	50° P/N	Old P/N	65° P/N	Old P/N
15	8.708-203.0	254260B	8.708-204.0	254261B	8.708-206.0	254262B	8.708-208.0	254264B	8.708-210.0	254265B	8.708-212.0	254266B
20	8.708-218.0	254270B	8.708-222.0	254271B	8.708-225.0	254272B	8.708-228.0	254274B	8.708-230.0	254275B	8.708-232.0	254276B
30	8.708-242.0	254290B	8.708-244.0	254291B	8.708-246.0	254292B	8.708-249.0	254294B	8.708-251.0	254295B	8.708-253.0	254296B
40	8.708-258.0	254300B	8.708-260.0	254301B	8.708-262.0	254302B	8.708-264.0	254304B	8.708-266.0	254305B	8.708-268.0	254306B
50	8.708-275.0	254310B	8.708-277.0	254311B	8.708-279.0	254312B	8.708-280.0	254314B	8.708-282.0	254315B	8.708-284.0	254316B
60	8.708-289.0	254320B	8.708-290.0	254321B	8.708-292.0	254322B	8.708-294.0	254324B	8.708-296.0	254325B	8.708-297.0	254326B
70	8.708-302.0	254330B	8.708-304.0	254331B	8.708-306.0	254332B	8.708-308.0	254334B	8.708-309.0	254335B	8.708-310.0	254336B

Nozzles - Broad Spray Stainless-Steel

1/4" male pipe thread 303 stainless-steel Vee Jet nozzles, low- to medium-volume up to 500 PSI medium-pressure/special application PSI.



1/4" Male Threads

Nozzle Size	Orifice Dia	50° P/N	Old P/N	65° P/N	Old P/N	80° P/N	Old P/N	95° P/N	Old	110° P/N	Old P/N
1.0	.026	8.708-074.0	254105	8.708-075.0	254106	8.708-076.0	254107	8.708-078.0	254108	8.708-079.0	254109
1.5	.031	8.708-085.0	254115	8.708-086.0	254116	8.708-087.0	254117	8.708-089.0	254118	8.708-090.0	254119
2.0	.036	8.708-095.0	254125	8.708-096.0	254126	8.708-097.0	254127	8.708-099.0	254128	8.708-101.0	254129
3.0	.043	8.708-108.0	254135	8.708-109.0	254136	8.708-110.0	254137	8.708-112.0	254138	8.708-114.0	254139
4.0	.047	8.708-121.0	254145	8.708-122.0	254146	8.708-123.0	254147	8.708-125.0	254148	8.708-127.0	254149
5.0	.053	8.708-133.0	254155	8.708-134.0	254156	8.708-136.0	254157	8.708-138.0	254158	8.708-140.0	254159
6.0	.058	8.708-148.0	254175	8.708-149.0	254176	8.708-151.0	254177	8.708-155.0	254178	8.708-157.0	254179
7.0	.063	–	254195	8.708-163.0	254196	–	254197	–	–	–	–
8.0	.067	8.708-172.0	254215	8.708-173.0	254216	8.708-175.0	254217	8.708-177.0	254218	8.708-179.0	254219

Tip-Jet Nozzle System – Tips and Components

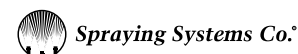

“Tip-Jet” Nozzle Systems are versatile nozzling systems for everyday or specialized applications. Flat spray, full cone, hollow cone and solid stream patterns, metering orifices and atomizing tips are all available in the Tip-Jet system. Capacities range from .55 to 20 GPM.



Tip-Jet Tips

- Neat and simple tip change
- Hardened stainless-steel tips with vanes for maximum spray integrity
- Strainers available
- Body components available in brass, zinc-plated steel or stainless-steel
- Rated to 4000 PSI

Orifice	0° Part No	Old No	15° Part No	Old No	25° Part No	Old No	40° Part No	Old No
3.0	8.708-016.0	253316	8.708-017.0	253317N	8.708-018.0	253318	–	–
4.0	8.708-019.0	253330	8.708-020.0	253331	8.708-021.0	253332	8.708-022.0	253333
4.5	8.708-023.0	253338	8.708-024.0	253339	8.708-025.0	253340	8.708-026.0	253341
5.0	8.708-027.0	253346	8.708-028.0	253348	8.708-029.0	253349	8.708-030.0	253350
5.5	8.708-031.0	253355	8.708-032.0	253357	8.708-033.0	253358	8.708-034.0	253359
6.0	8.708-035.0	253365	8.708-036.0	253367	8.708-037.0	253368	8.708-038.0	253369
6.5	8.708-039.0	253375	–	–	8.708-040.0	253377	8.708-041.0	253378
7.0	8.708-042.0	253383	8.708-043.0	253385	8.708-044.0	253386	8.708-045.0	253387
7.5	8.708-046.0	253392	8.708-047.0	253393	8.708-048.0	253394	8.708-049.0	253395
8.0	8.708-050.0	253400	8.708-051.0	253401	8.708-052.0	253402	8.708-053.0	253403
9.0	8.708-054.0	253415	8.708-055.0	253416	8.708-056.0	253417	8.708-057.0	253418
10.0	8.708-058.0	253456	8.708-059.0	253457	8.708-060.0	253458	8.708-061.0	253459



Tip-Jet Nozzle Bodies, MPT inlet connections in 1/4", 3/8" and 1/2" sizes. All outlet connections are 11/16" — 16 male thread to fit Tip-Jet tip retainers and adapters.



Tip-Jet Nozzle Bodies

Part No	Old No	Material, MPT-1/4"
8.707-886.0	252511	Nylon
8.707-898.0	252640B	Brass
8.707-899.0	252642	Stainless-steel
8.707-916.0	252861P	Polypropylene



Tip-Jet Adapter Caps

Tip-Jet Adapter Caps, similar to tip retainers, but have FPT connections for in-line applications.

Part No	Old No	Material, MPT
8.707-919.0	252878B	Brass, 1/8"
8.707-921.0	252880B	Brass, 1/4"
8.707-922.0	252881	Stainless-Steel, 1/4"



Tip-Jet Retainer Caps

Tip-Jet Retainer Caps, fits all Tip-Jet nozzle bodies, holds spray tips and metering orifices firmly in place.

Part No	Old No	Material, MPT
8.707-915.0	252858B	Brass, Hex
8.707-918.0	252875	Plated Steel, Hex
8.707-888.0	252565	Stainless-Steel, Hex



Tip Retainer 18 mm thread, fits vent grip lance. See tip jet nozzles in nozzle section.

Part No	Old No	Description
8.710-901.0	373065	Tip Retainer



Tip-Jet Strainers

Tip-Jet Strainers fit into nozzle body cavity to stop nozzle clogging. Brass with stainless-steel mesh.

Part No	Old No	Material, MPT
8.707-894.0	252627	50-Mesh
8.707-895.0	252629	100-Mesh
8.707-896.0	252631	200-Mesh

Soft-Edge and Hard-Edge Nozzle Protector

Ideal for protecting sensitive surfaces against damage. Hard plastic body is stable enough to tightly hold nozzle adapter for heavy-duty use.

- 1/4" FPT inlet/outlet
- 300°F



Part No	Description
8.723-668.0	ST-10 Zinc-plated Nozzle Adapter
8.723-669.0	ST-10 Stainless-steel Adapter

Soap Nozzles

“Black” Soap Nozzles, are brass with a large #40 orifice. Ideal for low-pressure chemical applications.



Part No	Old No	Size	Nozzle Degree
8.708-478.0	255905B	40	25°
8.708-479.0	255920B	40	65°

Rosebud Nozzle Guard

Molded rubber guard fits tightly around the nozzle to protect the nozzle and painted surfaces.

- 1/8" meg



Part No	Old No	Description
8.710-870.0	373012	Nozzle Guard

NOZZLES

Turbo Nozzle The Legacy Revolution



Legacy is proud to offer the Revolution rotary nozzle. This turbo rotary nozzle is rated for up to 4350 PSI at 185°F. Turning at an astounding 4,000 RPM, the Revolution delivers faster and deeper cleaning action for the same price of 3000 PSI rotary nozzles.



With the Legacy Revolution turbo nozzle, you get:

- Greater cleaning power: The Revolution is engineered to increase the impact pressure by more than 10 times that of conventional nozzles!
- Longer operating life: The Revolution's operating life is extended significantly by its wear-resistant ceramic nozzle and bearing ring.
- More durable and versatile: The Revolution features an extra-resilient housing protector and is capable of handling a stream of up to 4350 PSI at 185°F.

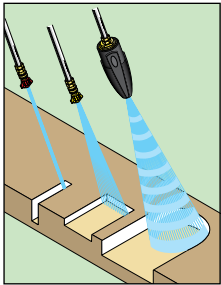

Legacy's Revolution gives you the best of both worlds: the deep cleaning impact of a 0° nozzle and the fast cleaning of a wide-coverage fan spray nozzle.

Nozzle Part No	Old No	Orifice	PSI
9.302-242.0	374231	3.5	4350
9.302-243.0	374232	4.0	4350
9.302-244.0	374233	4.5	4350
9.302-245.0	374234	5.0	4350
9.302-246.0	374235	5.5	4350
9.302-247.0	374236	6.5	4350
9.302-248.0	374237	7.0	4350
9.302-249.0	374238	12.0	4350
Repair Kit			
2.884-972.0	079920	3.5	
2.883-824.0	079921	4.0	
9.302-231.0	079922	4.5	
2.883-823.0	079923	5.0	
2.883-822.0	079924	5.5	
9.302-234.0	079925	6.5	
2.884-974.0	079926	7.0	
2.884-975.0	079927	10.0	
2.884-051.0	079928	12.0	

Turbo Nozzles



AP Revolution Turbo Nozzle is rated for up to 5100 PSI at 212°F. High-impact nozzle at unbelievable pricing!



- Forged brass
- Precision ceramic
- Durable rubber cover

Nozzle Part No	Orifice	Repair Kit Part No	Orifice
3000 PSI			
8.726-056.0	3.5	8.726-062.0	3.5
8.726-057.0	4.0	8.726-063.0	4.0
8.726-058.0	4.5	8.726-064.0	4.5
8.726-059.0	5.0	8.726-065.0	5.0
8.726-060.0	5.5	8.726-066.0	5.5
8.726-061.0	6.0	8.726-067.0	6.0
4000 PSI			
8.726-068.0	3.5	8.726-074.0	3.5
8.726-069.0	4.0	8.726-075.0	4.0
8.726-070.0	4.5	8.726-076.0	4.5
8.726-071.0	5.0	8.726-077.0	5.0
8.726-072.0	5.5	8.726-078.0	5.5
8.726-073.0	6.0	8.726-079.0	6.0
5100 PSI			
8.726-080.0	3.5	8.726-086.0	3.5
8.726-081.0	4.0	8.726-087.0	4.0
8.726-082.0	4.5	8.726-088.0	4.5
8.726-083.0	5.0	8.726-089.0	5.0
8.726-084.0	5.5	8.726-090.0	5.5
8.726-085.0	6.0	8.726-091.0	6.0

Turbo A+ Nozzle Kit

- 4000 PSI
- With 8.726-069.0 Nozzle
- With 8.710-149.0 Inlet filter



Part No	Description
8.928-444.0	Kit, A+ Turbo Nozzle #4

Rotojet 3700 / Rotojet 5800

0° Impact, 25° pattern, no gears — no teeth — no bearings. Exclusive design of the Rotojet 3700 / Rotojet 5800 eliminates start up impact and damage to internal nozzle.

- High-strength, forged brass
- Precision ceramic orifice and matching race
- Durable rubber/plastic cover
- 1/4" BSPP



Rotojet 3700 PSI

- 190°F
- British pipe thread compatible inline filters 8.709-979.0 and 8.709-978.0

3700 PSI				Repair Kit			
Part No	Old No	Size	PSI	Part No	Old No	Size	PSI
8.711-002.0	374130	3.0	3700	8.704-039.0	109297	3.0	3700
8.711-003.0	374131	3.5	3700	8.704-038.0	109296	3.5	3700
8.711-005.0	374134	4.0	3700	8.704-040.0	109298	4.0	3700
Part No	Old No	Size	PSI	Part No	Old No	Size	PSI
8.711-004.0	374132	4.5	3700	8.704-041.0	109299	4.5	3700
8.711-006.0	374135	5.0	3700	8.704-042.0	109300	5.0	3700
Part No	Old No	Size	PSI	Part No	Old No	Size	PSI
8.711-008.0	374137	5.5	3700	8.704-043.0	109301	5.5	3700
8.711-007.0	374136	6.0	3700	8.704-044.0	109302	6.0	3700

Must start with nozzle down.



Rotojet 5800 PSI

- 200°F

5800 PSI				Repair Kit			
Part No	Old No	Size	PSI	Part No	Old No	Size	PSI
8.711-009.0	374142	3.0	5800	8.704-065.0	109428	3.0	5800
8.711-010.0	374143	3.5	5800	8.704-066.0	109429	3.5	5800
8.711-011.0	374144	4.0	5800	8.704-067.0	109430	4.0	5800
8.711-012.0	374145	4.5	5800	8.704-068.0	109431	4.5	5800
8.711-013.0	374146	5.0	5800	8.704-069.0	109432	5.0	5800
Part No	Old No	Size	PSI	Part No	Old No	Size	PSI
8.711-014.0	374148	5.5	5800	8.704-070.0	109433	5.5	5800
8.711-015.0	374150	6.0	5800	8.704-071.0	109434	6.0	5800
8.711-016.0	374151	6.5	5800	8.704-072.0	109435	6.5	5800
8.711-017.0	374153	7.0	5800	8.704-073.0	109436	7.0	5800
8.711-018.0	374156	8.0	5800	8.704-074.0	109437	8.0	5800
Part No	Old No	Size	PSI	Part No	Old No	Size	PSI
8.711-019.0	374158	9.0	5800	8.704-075.0	109438	9.0	5800
8.711-020.0	374160	10.0	5800	8.704-076.0	109439	10.0	5800
8.711-023.0	374162	11.0	5800	8.704-077.0	109440	11.0	5800
8.711-021.0	374161	12.0	5800	8.704-078.0	109441	12.0	5800

Nozzle - Turbo

Provides great impact and cleaning power.



8.711-098.0



8.711-088.0

Part No	Old No	Orifice	PSI
8.711-105.0	374369	3.0	3650
8.711-097.0	374361	3.5	3650
8.711-098.0	374362	4.0	3650
8.711-099.0	374363	4.5	3650
8.711-100.0	374364	5.0	3650

Part No	Old No	Orifice	PSI
8.711-086.0	374350	3.0	5100
8.711-087.0	374351	3.5	5100
8.711-088.0	374352	4.0	5100
8.711-089.0	374353	4.5	5100
8.711-090.0	374354	5.0	5100

Part No	Old No	Orifice	PSI
8.711-101.0	374365	5.5	3650
8.711-102.0	374366	6.0	3650
8.711-096.0	374360	6.5	3650
8.711-103.0	374367	7.0	3650
8.711-104.0	374368	8.0	3650

Part No	Old No	Orifice	PSI
8.711-091.0	374355	5.5	5100
8.711-092.0	374356	6.0	5100
8.711-093.0	374357	6.5	5100
8.711-094.0	374358	7.0	5100
8.711-095.0	374359	8.0	5100

Turbo Nozzle Repair Kits (for 3650 and 5100 PSI)

Part No	Description
8.749-912.0	Repair Kit YR51K30
8.749-913.0	Repair Kit YR51K35
8.749-914.0	Repair Kit YR51K40
8.749-915.0	Repair Kit YR51K45
8.749-916.0	Repair Kit YR51K50
8.749-917.0	Repair Kit YR51K55
8.749-918.0	Repair Kit YR51K60
8.749-919.0	Repair Kit YR51K65
8.749-920.0	Repair Kit YR51K70
8.749-921.0	Repair Kit YR51K80

Nozzles - Suttner Turbo



■ Forged brass

■ Rubber cover/protector

■ Precision ceramic orifice

■ 190°F



ST-357 – 3600 PSI

ST-357

Part No	Old No	Size	PSI
8.710-986.0	374103	3.0	3600
8.710-987.0	374104	3.5	3600
8.710-989.0	374106	4.0	3600
8.710-988.0	374105	4.5	3600
8.710-991.0	374107	5.0	3600
8.710-993.0	374109	5.5	3600
8.710-992.0	374108	6.0	3600

ST-357 – Repair Kit

Part No	Old No	Size	PSI
8.701-570.0	085458	3.0	3600
8.701-569.0	085457	3.5	3600
8.701-564.0	085452	4.0	3600
8.701-562.0	085449	4.5	3600
8.701-565.0	085453	5.0	3600
8.701-568.0	085456	5.5	3600
8.701-566.0	085454	6.0	3600



ST-457 – 5800 PSI

ST-457

Part No	Old No	Size	PSI
8.711-072.0	374300	3.0	6000
8.711-073.0	374301	3.5	6000
8.711-074.0	374302	4.0	3600
8.711-075.0	374303	4.5	6000
8.711-076.0	374304	5.0	6000
8.711-077.0	374305	5.5	6000
8.711-078.0	374306	6.0	6000
8.711-079.0	374308	7.0	6000
8.711-080.0	374309	8.0	6000
8.711-081.0	374310	10.0	6000

ST-457 – Repair Kit

Part No	Old No	Size	PSI
8.701-572.0	085465A	3.0	6000
8.701-571.0	085465	3.5	6000
8.701-573.0	085466	4.0	6000
8.701-574.0	085467	4.5	6000
8.701-575.0	085468	5.0	6000
8.701-576.0	085469	5.5	6000
8.701-577.0	085470	6.0	6000
8.701-578.0	085472	7.0	6000
8.701-579.0	085473	8.0	6000
8.701-580.0	085474	10.0	6000

Nozzle - Dirt Killer Rotating

4700 maximum PSI, a popular model providing great impact and leaning power.

- 180°F maximum temperature
- 1/4" inlet



8.712-429.0

Part No	Old No	Orifice	PSI
8.712-429.0	4-20091	045	3200
8.701-160.0	4-200910	Repair Kit	
8.740-148.0	4-20092	055	4700
8.701-161.0	4-200920	Repair Kit	

Rotojet Soft – Hard Rotating Nozzle

Offers the cleaning efficiency of a high-pressure rotating nozzle with the feature of changing from a hard spray for concrete to a soft spray for wood by simply pushing or pulling the finger protected nozzle.

- 3600 PSI



8.711-054.0

Part No	Old No	Orifice
8.711-052.0	374245	030
8.711-053.0	374246	035
8.711-054.0	374247	040
8.711-055.0	374248	045

MV Triple-Function Nozzle

Provides three cleaning options: low-pressure for soap or chemical application; a 15° angle for high-pressure cleaning; and a rotating nozzle for maximum cleaning efficiency.

- 3000 PSI



8.711-068.0

Part No	Old No	Orifice
8.711-067.0	374291	035
8.711-068.0	374292	040

Lance Nozzle Couplers

Changes MPT lance to FPT for mounting MPT nozzles.



Part No	Old No	Description
Brass		
8.705-150.0	140452	1/8" x 1/8"
8.705-155.0	140502	1/4" x 1/8"
8.705-151.0	140454	1/4" x 1/4"
Steel		
8.710-713.0	368903	1/8" X 1/8"
8.710-712.0	368902	1/4" x 1/8"
8.710-714.0	368904	1/4" x 1/4"

Rotomax Rotating Nozzle 3500 and 5800 PSI



- Up to 5800 PSI max pressure
- 1/4" FPT inlet
- 176°F max temperature
- Weight 9 oz
- Replaceable stainless-steel orifices



Part No	Old No	Description	PSI	Std Nozzle Equiv
8.711-035.0	374205	Rotomax I	3500	4.5
8.711-036.0	374210	Rotomax II	3500	5.5
8.711-037.0	374215	Rotomax III	3500	6.5
8.711-038.0	374216	Rotomax 401	5800	4.5
8.711-039.0	374217	Rotomax 403	5800	6.5
8.701-532.0	084400X	Repair Kit		

Viper Rotating Nozzle



- 5000 PSI max pressure
- 190°F max temperature
- 1/4" FPT inlet
- Weight 1.0 oz



Part No	Old No	Description	PSI	Std Nozzle Equiv
8.711-000.0	374126	Viper	5000	4.5
8.711-001.0	374127	Viper	5000	5.5
8.701-163.0	080004	Repair Kit	5000	4.5
8.701-166.0	080006	Repair Kit	5000	5.5

NOZZLES

MV Hi-Lo Turbo Nozzle



Combines the power of a 0° stream and a 20° wide-angle spray pattern to improve cleaning. Hi-Lo pressure feature eliminates changing to a low-pressure nozzle for soap and chemical application.

■ 2500 PSI

8.711-070.0



Part No	Old No	Orifice
8.711-069.0	374294	030
8.711-070.0	374295	035

Rotojet 2000

Economy turbo nozzle.

- Great for economy washers
- 2000 PSI max pressure

- 1/4" FPT inlet
- 5.4 oz weight
- 140°F max temperature



Part No	Old No	Size	Color
8.711-026.0	374175	3.0	Yellow
8.711-027.0	374176	3.5	Black
8.711-028.0	374177	4.0	Blue

Nozzle - Duo-Reg



Duo-Reg Nozzles are designed for industrial use in ALL applications. Easy push/pull, low-to-high pressure change, and easy-turn to adjust from 0° to 80° fan pattern

- Stainless-steel replaceable orifices
- 3000 PSI capability
- 300°F
- 1/4" FPT connect
- Tough glass-filled nylon cover
- Compact size: 3-3/8" long, 1-3/16" diameter, 5.7 oz weight



Part No	Old No	Color	Orifice
8.710-959.0	374030	Yellow	3.0
8.710-960.0	374035	White	3.5
8.710-961.0	374040	Blue	4.0
8.710-962.0	374045	Brown	4.5
8.710-963.0	374050	Green	5.0
8.710-964.0	374055	Sky	5.5
8.710-965.0	374060	Black	6.0
8.710-966.0	374065	Drk Green	6.5

Rollover Nozzle Head - ST-56



- Brass body
- 3600 PSI max pressure
- 8 GPM max flow
- 300°F max temperature

- Glass-filled polyimide cover
- 1/4" FPT inlet and outlet



Part No	Old No	Description
8.710-895.0	373056	Rollover Nozzle Head

Nozzle - Multi-Fan



Adjust from maximum Impact Zero Stream to 80° wide-angle spray with a twist of the nozzle body

- 1/4" FPT connect
- 2900 PSI
- Replaceable stainless steel orifices
- Stainless-steel deflector
- 210°F



Part No	Old No	Color	Orifice
8.710-932.0	373352	Yellow	3.0
8.710-933.0	373353	White	3.5
8.710-934.0	373354	Blue	4.0
8.710-935.0	373356	Brown	4.5
8.710-936.0	373357	Green	5.0
8.710-937.0	373358	Sky	5.5
8.710-938.0	373359	Black	6.0
8.710-939.0	373360	-	6.5
8.710-940.0	373361	-	7.0
8.710-941.0	373362	-	7.5
8.710-942.0	373363	-	8.0

Interchangeable Orifice – Fits Nozzles Above

Replacement Orifices for duo-reg and multi-fan nozzles.



Part No	Old No	Orifice
8.701-448.0	084021	3.0
8.701-449.0	084023	3.5
8.701-450.0	084025	4.0
8.701-452.0	084027	4.5
8.701-453.0	084028	5.0
8.701-454.0	084029	5.5
8.701-455.0	084030	6.0
8.701-456.0	084031	6.5
8.701-458.0	084033	7.0
8.701-459.0	084034	7.5
8.701-460.0	084035	8.0

High-Pressure Nozzle Filters

Turbo nozzle protector.

- 1/4" MPT outlet
- 300°F max temperature
- 100-mesh screen
- 5000 PSI max pressure



8.709-978.0

8.709-979.0



8.710-150.0



8.710-149.0

Part No	Old No	Material	Inlet	Outlet
8.709-978.0	342040	Brass	1/4" FPT	1/4" MPT
8.709-979.0	342042	Brass	1/4" QC	1/4" MPT
8.710-149.0	347097	416 SS	1/4" QC	1/4" MPT
8.710-150.0	347098	Brass	1/4" MPT	1/4" MPT
8.704-234.0	110595	Replacement filter for 342040/342042		
8.701-201.0	080115	Replacement filter for 347097/347098		

HL250 High/Low Variable Angle Nozzle



Push/Pull for easy change between high- and low-pressure; simple twist to adjust 0°-80° spray fan pattern.

- Stainless-steel replaceable orifice
- Durable glass-filled nylon cover
- 200°
- 4000 PSI
- 1/4" FPT inlet
- Weight: .4 lbs



Part No	Old No	Color	Orifice
8.710-972.0	374086	Lt Green	2.0
8.710-973.0	374087	Pink	2.5
8.710-974.0	374088	White	3.0
8.710-975.0	374090	Brown	3.5
8.710-976.0	374091	Dk Yellow	4.0
8.710-977.0	374092	Blue	4.5
8.710-978.0	374093	Purple	5.0
8.710-979.0	374094	Dark Red	5.5
8.710-980.0	374095	Dk Green	6.0
8.710-982.0	374097	Orange	7.0
8.710-983.0	374098	Silver	8.0

Double Nozzle Head

- Durable machined-brass body
- Stainless-steel ball
- Chemical-resistant
- 3600 PSI max pressure
- 300°F max temperature
- Up to 10 GPM flow for low side pressure at 250 PSI
- Heavy nickel-plate
- 1/4" female inlet, two female outlets
- New ball guide and seat



Part No	Old No	Description
8.710-897.0	373058A	Double Nozzle Head

ST-51N Adjustable Nozzle



Nozzle holder allows water to be diverted around the fixed orifice nozzle, dropping the pressure and allowing the chemical injector to operate.

- Attaches to 1/4" MPT lance
- Accepts 1/4" meg nozzles
- 8.0 GPM max flow
- 300°F max temperature
- 3600 PSI max pressure
- 5.9 oz weight



Part No	Old No	Description
8.710-889.0	373051	ST-51N

Variable Angle Nozzle

- One-piece brass
- 1450 PSI
- Steam nozzle – 1/4" F
- Steam blank – 3/8" M



Part No	Description
8.710-971.0	Variable Angle Nozzle

Rollover Nozzle – Twist-Type

Holds two meg nozzles on opposite sides for positive change from chemical application to high-pressure rinse.

- Nickel-plated brass body
- 180°F max temperature
- 1000 PSI max pressure



Part No	Old No	Description
8.710-893.0	373054	Dual 1/4" FPT in/out
8.900-022.0	075020X	Repair Kit

Adjustable Nozzle



Compact, full-feature unit weighs only 4.3 oz, same functions as ST-51N.

- 3600 PSI max pressure
- 10 GPM max flow
- 300°F max temperature
- Machined-brass body
- Nylon adjustment knob
- 1/4" FPT inlet/outlet



Part No	Old No	Description
8.710-891.0	373051P	Adjustable Nozzle

Steam Nozzle

- One-piece brass
- 1450 PSI
- Steam nozzle – 1/4" F
- Steam blank – 3/8" M



Steam Nozzle Blank

Flat Steam Nozzle

Part No	Old No	Description
8.710-958.0	373710	Flat Steam Nozzle, 1.5mm
8.710-957.0	373702	Steam Nozzle Blank – Drill to Size
8.904-374.0	373705	Nozzle Blank, Drilled to 1.6mm
8.712-415.0		Steam Nozzle, Drilled to 5/64"

Slip-on Nozzle Protector

A durable, easy-to-use nozzle protector. Plastic rubber compound — flexible and tough!

- 1-1/2" diameter at flare-end
- Slip-fits standard lances
- 2-1/2" long
- Only 1.2 oz!
- Slip-on to Lance
- Attach nozzle coupler and nozzle
- Slide protector forward for complete nozzle protection



Part No	Old No	Description
8.710-868.0	373006	Slip-on Nozzle Protector

NOZZLES

Sewer/Tube Cleaning Nozzles



The reverse jets on the fixed and rotary nozzles pull the hose through the tube or sewer line and blast debris from line or tube walls.

- 4200 PSI
- Physically small for cornering ability
- Corrosion-resistant stainless-steel construction
- Orifice size indicated on non-rotating styles
- Backward ports drive the nozzle forward and flush debris
- Forward ports blast into pipe and breaks up clogs and debris
- Rotating style adds extra agitation and surface cleaning

Part No	Old No	Nozzle	Orifice Size	O.D.	Ports
Non-Rotating Sewer Nozzles					
8.710-875.0	373024	1/8"	4.5	.580"	0-forward, 3 back
8.710-874.0	373023	1/8"	5.5	.580"	1-forward, 3 back
8.710-878.0	373027	1/4"	4.5	.730"	1-forward, 3 back
8.710-876.0	373025	1/4"	5.5	.730"	1-forward, 3 back
8.710-877.0	373026	1/4"	6.0	.730"	1-forward, 4 back
8.710-880.0	373029	1/4"	7.5	.730"	1-forward, 4 back
8.710-879.0	373028	1/4"	8.0	.730"	1-forward, 3 back
8.710-881.0	373032	1/4"	12	.730"	1-forward, 3 back
8.710-885.0	373038	3/8"	4.0	.920"	1-forward, 3 back
8.710-884.0	373037	3/8"	5.5	.920"	1-forward, 3 back
8.710-886.0	373039	3/8"	8.5	.920"	1-forward, 4 back
8.710-883.0	373036	3/8"	12	.920"	1-forward, 4 back
8.710-882.0	373035	3/8"	14	.920"	1-forward, 4 back

Part No	Old No	Rotating Nozzle Size	Ports
Rotating Sewer Nozzles			
8.710-899.0	373062	1/8"	0-forward, 3 back
8.710-898.0	373061	1/4"	0-forward, 3 back
8.710-900.0	373064	1/4"	0-forward, 3 back
8.710-887.0	373040	1/4" Duct Clnr*	0-forward, 2 side

*Duct Cleaner jet to sides instead of reverse



0-forward, 3 back ports

1-forward, 4 back ports



1-forward, 3 back ports

- Rotating sewer nozzle
- Adds extra agitation
- 4000 PSI
- Back Jet Only



0-forward, 3 back ports

0-forward, 2 side ports

Legacy Compact Foamer



Generates a high-density clinging foam for extended dwell time to increase chemical action.

- Stainless-steel, aluminum and brass
- 5" long, 1" diameter
- 4 and 6.5 nozzle included
- 1-5 GPM max flow
- 195°F max temperature
- 2500 PSI max pressure



Part No	Old No	Description
8.903-998.0	344022V	1/8" F Inlet
8.903-999.0	344023V	1/4" F Inlet

NOTE: Most cleaning chemicals perform best when applied at 120°-150°F and can be applied as a foam by adding a foaming agent. See your chemical supplier to obtain the correct product.

Nozzle Protector/Coupler

- Protect nozzles and finished surfaces
- Deep nozzle recess
- Tough plastic protector
- 1/4" FPT coupler inlet



Part No	Old No	Nozzle
8.710-866.0	373002	1/8"
8.710-867.0	373004	1/4"

Foam Cannon

The ideal foam generator application accessory meters the foaming chemical for customized foam type and applies the foam to match the application.



- Stainless-steel 1.5mm orifice (#5.5 nozzle equivalent)
- Brass meter valve
- 3200 PSI max pressure
- High-impact glass-filled body
- 4.8 GPM max flow
- Stainless-steel foam turbulator
- 140°F max temperature
- 1/4" FPT lance connect

Part No	Old No	Description
8.710-125.0	344030	Foam Cannon/ Injector
8.710-126.0	344032	Foam Cannon/ Injector/Bottle
8.704-222.0	110311	Replacement Turbulator Screen

Legacy HD Pumps — the most durable pump on the market.



Legacy is introducing the next wave in high-pressure pumps, the Legacy HD Pump. This heavy-duty, high-pressure pump is the outcome of years of research and development, resulting in a number of upgrades over previous pump models. Premium, long-life components and new design features make the Legacy HD pump a standout among other high-pressure pumps. Tests prove it will hold up better in rugged working conditions

Stronger crankcase housing with thicker aluminum cross members and mounting feet for added strength.

Oil level dipstick is vented allowing for heat expansion. Oil level sight glass allows for quick and easy oil inspection.

Crankcase features longer overall length to ensure less stress on all parts and a longer life of the pump.

Premium European-quality tapered roller bearings on both the drive-side and opposite-drive-side of the pump allow for heavier and demanding loads while greatly reducing noise levels and heat build-up.

Super-strong, two-piece connecting rods designed with double-feeder grooves to maximize lubrication for a dramatically cooler running pump.

High-temperature, long-life U-seals correctly fitted for each pump.

Dacromet® finish on manifold bolts adds extra rust protection.

Precision machined crankshafts for easy assembly and disassembly. Solid-shaft models have a full 55mm shaft length to easily accept pulley and sheaves.

Polished stainless-steel plunger rod reduces friction heat for a smoother and cooler operation.

Precision-ground and highly-polished solid ceramic plungers designed and manufactured to withstand dramatic temperature and pressure spikes.

5 YR. LIMITED WARRANTY

Revolutionary forged-brass heads with exclusive “deep-well-sealing” valve caps eliminate any head pressure effects to the valve cap and valve cap thread.

Take the Legacy HD Pump Durability Challenge!

We believe the Legacy HD Pump is the strongest, most durable pump in the market. We’ve tested the pump in extreme conditions and are confident in its strength and performance. We ran the pump dry in separate tests for 24 hours, and the pump showed no sign of wear. We challenge you to try the new Legacy HD Pump. Run the pump dry. Take it apart and look how well it holds up. The Legacy HD holds up in these extreme conditions. Imagine how it will perform with everyday regular use!

Belt Drive Pumps



GX SERIES: 1/2" inlet x 3/8" outlet

Part No	Model No.	GPM	PSI	HP	RPM	Shaft	Weight
8.921-661.0	GX5450R	5.4	5000	17.0	1740	24mm	39 lbs
8.921-662.0	GX5450L	5.4	5000	17.0	1740	24mm	39 lbs
8.920-597.0	GX9536.2R	9.5	3625	23.6	1740	24mm	38 lbs
8.920-598.0	GX9536.2L	9.5	3625	23.6	1740	24mm	38 lbs
8.920-599.0	GX1036.2R	10.4	3625	25.8	1740	24mm	38 lbs
8.920-600.0	GX1036.2L	10.4	3625	25.8	1740	24mm	38 lbs
8.920-602.0	GX1622.2R	15.8	2200	23.8	1740	24mm	38 lbs
8.920-603.0	GX1622.2L	15.8	2200	23.8	1740	24mm	38 lbs
8.752-809.0	GX8043.2	7.9	4350	23.5	1740	25mm	38 lbs

Legacy Pumps (continued) – Belt Drive Units



GM Series

GM SERIES: 1/2" inlet x 3/8" outlet

Part No	Model #	GPM	PSI	HP	RPM	Shaft	Weight
8.751-197.0	GM3540R.3	3.5	4000	9.5	1850	24mm	22 lbs
8.751-198.0	GM4030R.3	4	3000	8.2	1000	24mm	22 lbs
8.751-200.0	GM4035R.3	4.8	3500	7.5	1500	24mm	22 lbs
8.751-201.0	GM4035L.3-Left	4.8	3500	7.5	1500	24mm	22 lbs
8.751-202.0	GM5030R.3	5.1	3000	13.5	1550	24mm	22 lbs
8.751-203.0	GM5030L.3	5.1	3000	13.5	1550	24mm	22 lbs
8.751-244.0	GM6035R.3	5.6	3500	13.5	1750	24mm	22 lbs
8.751-245.0	GM6035L.3	5.6	3500	13.5	1750	24mm	22 lbs



GT Series

GT SERIES: 1/2" inlet x 3/8" outlet

Part No	Model #	GPM	PSI	HP	RPM	Shaft	Weight
8.921-722.0	GT4540.2R	4.5	4000	12.3	1360	25mm	39 lbs
8.921-723.0	GT4540.2L	4.5	4000	12.3	1360	25mm	39 lbs
8.921-724.0	GT6036.2R	6.0	3600	14.8	1450	25mm	39 lbs
8.921-725.0	GT6036.2L	6.0	3600	14.8	1450	25mm	39 lbs
8.921-726.0	GT5636.2R	5.6	3600	13.8	1450	24mm	39 lbs
8.921-727.0	GT5636.2L	5.6	3600	13.8	1450	24mm	39 lbs



GB Series

GB SERIES: 1/2" inlet x 3/8" outlet

Part No	Model #	GPM	PSI	HP	RPM	Shaft	Weight
8.923-809.0	GB3030R	3.0	3000	6.2	1650	24mm	14.5 lbs
8.923-810.0	GB3030L	3.0	3000	6.2	1650	24mm	14.5 lbs
8.923-811.0	GB4025R	4.0	2500	6.8	1550	24mm	14.5 lbs
8.923-812.0	GB4025L	4.0	2500	6.8	1550	24mm	14.5 lbs

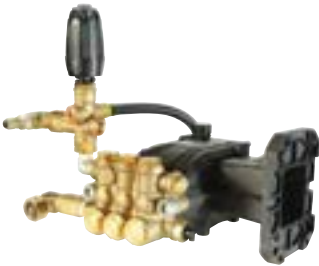

RTG Series

READY TO GO SERIES:

- Includes a pump, unloader, thermal protector, bypass loop hose, garden hose inlet with filter, and quick coupler.

Part No	Model #	TYPE	GPM	PSI	RPM	Shaft	Unloader
8.924-458.0	GP3035G	Direct	3.0	3500	3400	3/4"	VRT3
8.924-459.0	GP3535G1	Direct	3.5	3500	3400	1"	VRT3
8.924-460.0	GS4040G.3	Direct	4.0	4000	3400	1"	VRT3
8.924-461.0	GB3030R	Belt	3.0	3000	1650	24mm	VRT3
8.924-462.0	GM3540R.3	Belt	3.5	4000	1850	24mm	VRT3
8.924-463.0	GM3840R.3	Belt	3.8	4000	1740	24mm	VRT3

Legacy Pumps – Belt Drive Units



HFR Series

HFR SERIES:

■ 1"-1-1/4" inlet x 3/4" outlet

Part No	Model No.	GPM	PSI	HP	RPM	Shaft Dia	Inlet	Outlet	Wt (lbs)
8.751-672.0	HFR40SL	10.6	4100	29.8	1000	40mm	1"	3/4"	106 lbs
8.751-673.0	HFR40SR	10.6	4100	29.8	1000	40mm	1"	3/4"	106 lbs
8.751-674.0	HFR60SR	15.9	4100	44.7	1000	40mm	1"	3/4"	106 lbs
8.751-675.0	HFR60SL	15.9	4100	44.7	1000	40mm	1"	3/4"	106 lbs
8.751-676.0	HFR40FL	10.6	4100	29.8	1450	40mm	1"	3/4"	106 lbs
8.751-677.0	HFR40FR	10.6	4100	29.8	1450	40mm	1"	3/4"	106 lbs
8.751-678.0	HFR60FR	15.9	4100	44.7	1450	40mm	1"	3/4"	106 lbs
8.751-679.0	HFR60FL	15.9	4100	44.7	1450	40mm	1"	3/4"	106 lbs
8.751-680.0	HFR80FL	21.1	4100	59.3	1450	40mm	1"	3/4"	106 lbs
8.751-681.0	HFR80FR	21.1	4100	59.3	1450	40mm	1"	3/4"	106 lbs
8.751-688.0	HFR80SL	21.1	2200	31.8	1000	40mm	1-1/4"	3/4"	106 lbs
8.751-689.0	HFR80SR	21.1	2200	31.8	1000	40mm	1-1/4"	3/4"	106 lbs
8.751-690.0	HFR105SL	27.7	2200	41.7	1000	40mm	1-1/4"	3/4"	106 lbs
8.751-691.0	HFR105SR	27.7	2200	41.7	1000	40mm	1-1/4"	3/4"	106 lbs
8.751-692.0	HFR120SL	31.7	2200	47.8	1000	40mm	1-1/4"	3/4"	106 lbs
8.751-693.0	HFR120SR	31.7	2200	47.8	1000	40mm	1-1/4"	3/4"	106 lbs

Legacy Pumps – Belt Drive Units



HHP Series

HHP SERIES:

■ 3/4" inlet x 1/2" outlet

Part No	Model No.	GPM	PSI	HP	RPM	Shaft Dia	Weight (lbs)
8.751-682.0	HHP25SL	6.6	7250	32.8	1000	40mm	112 lbs
8.751-683.0	HHP25SR	6.6	7250	32.8	1000	40mm	112 lbs
8.751-684.0	HHP30SR	7.9	7250	39.2	1000	40mm	112 lbs
8.751-685.0	HHP30SL	7.9	7250	39.2	1000	40mm	112 lbs
8.751-686.0	HHP38FL	10	5000	34.2	1450	40mm	112 lbs
8.751-687.0	HHP38FR	10	5000	34.2	1450	40mm	112 lbs
8.751-694.0	HHP4150R	10.8	7250	53.6	1450	40mm	112 lbs
8.751-695.0	HHP4150L	10.8	7250	53.6	1450	40mm	112 lbs
8.751-696.0	HHP3650R	9.5	7250	47.2	1450	40mm	112 lbs
8.751-697.0	HHP3650L	9.5	7250	47.2	1450	40mm	112 lbs
8.751-698.0	HHP2750R	7.1	7250	35.3	1450	40mm	112 lbs
8.751-699.0	HHP5750L	7.1	7250	35.3	1450	40mm	112 lbs
8.751-700.0	HHP5040R	13.3	5800	52.8	1740	40mm	112 lbs
8.751-701.0	HHP5040L	13.3	5800	52.8	1740	40mm	112 lbs



NMT Series

NMT SERIES:

■ 1/2" inlet x 3/8" outlet

Part No	Model No.	GPM	PSI	HP	RPM	Shaft Dia	Weight (lbs)
8.754-109.0	NMT1520CWR	4.7	3000	9.7	1740	24mm	21 lbs
8.754-110.0	NMT1520SCWR	4.8	3000	9.9	1200	24mm	21 lbs
8.754-111.0	NMT2120CWR	6.6	3000	13.6	1740	24mm	21 lbs
8.755-731.0	NMT2525IS	7.9	3625	19.6	1200	24mm	41 lbs



NMT ES Series

NMT ES SERIES:

■ 1/2" inlet x 3/8" outlet

Part No	Model No.	GPM	PSI	HP	RPM	Shaft Dia	Weight (lbs)
8.754-112.0	NMT2120ESR	6.6	3000	13.6	1740	24mm	26 lbs



Legacy Pumps – Direct Drive Units



GS Series

GS SERIES:

- 1/2" inlet x 3/8" outlet
- Direct couple-to-gas engine

Part No	Model #	GPM	PSI	HP	RPM	Shaft	Weight
8.751-205.0	GS3040G.3	3.0	4000	9.0	3400	1" Hollow	24.5 lbs
8.751-206.0	GS3540G.3	3.5	4000	11.0	3400	1" Hollow	23 lbs
8.751-207.0	GS4040G.3	4.0	4000	13.0	3400	1" Hollow	23 lbs
8.751-208.0	GS5030G.3	5.0	3000	16.0	3400	1" Hollow	24.5 lbs



GP Series

GP SERIES:

- 1/2" inlet x 3/8" outlet
- Direct couple-to-gas engine

Part No	Model #	GPM	PSI	HP	RPM	Shaft	Weight
8.923-813.0	GP2535G	2.5	3500	6.0	3400	3/4" Hollow	16.75 lbs
8.923-814.0	GP3035G	3.0	3500	7.2	3400	3/4" Hollow	16.75 lbs
8.923-815.0	GP3035G1	3.0	3500	7.2	3400	1" Hollow	18 lbs
8.923-816.0	GP3535G1	3.5	3500	8.4	3400	1" Hollow	18 lbs
8.923-817.0	GP4035G1	4.0	3500	9.6	3400	1" Hollow	18 lbs



GF Series

GF SERIES:

- 1/2-14 BSPP-F inlet x 3/8-19 BSPP-F outlet
- Direct couple-to-electric motor
- NEMA 56C Frame

8.923-818.0	GF2030F	2.1	3000	4.3	3450	5/8" Hollow	17 lbs
8.923-819.0	GF2030S	2.1	3000	4.3	1725	5/8" Hollow	17 lbs
8.923-820.0	GF2830F	2.8	3000	5.8	3450	5/8" Hollow	17 lbs
8.923-821.0	GF2830S	2.8	3000	5.8	1725	5/8" Hollow	17 lbs
8.923-822.0	GF3530F	3.5	3000	7.2	3450	3/4" Hollow	17 lbs



FOG Series

FOG SERIES:

- 3/8-19 BSPP-F inlet x 3/8-19 BSPP-F outlet
- Direct couple-to-electric motor
- NEMA 56C Frame

Part No	Model #	GPM	PSI	HP	RPM	Shaft	Weight
8.754-500.0	FOG0614R	0.6	1450	0.6	1740	5/8" Hollow	12 lbs
8.754-501.0	FOG1214R	1.2	1450	1.2	1740	5/8" Hollow	12 lbs
8.754-502.0	FOG1914R	1.9	1450	1.9	1740	5/8" Hollow	12 lbs
8.754-503.0	FOG2514R	2.5	1450	2.5	1740	5/8" Hollow	12 lbs



HY Series

HY SERIES:

- 1/2" inlet x 3/8" outlet
- Direct couple-to-electric motor

Part No	Model #	GPM	PSI	HP	RPM	Shaft	Weight
8.754-984.0	HY1515	4	3000	5.5	1450	5/8" Hollow	16.75 lbs
8.754-985.0	HY1520	4	3000	8.2	1450	5/8" Hollow	16.75 lbs

Legacy Pumps – Belt Drive Units



TML

TML SERIES:

- Industrial Triplex Plunger Pump with AI Connecting Rods
- 1450 RPM pulley drive with 24mm solid shaft, 1/2" inlet x 3/8" outlet, 18.9 lbs.
- Compare to: General Pumps — the TS series and AR Pumps — RK series.

Part No	Original No.	Model No.	Shaft	GPM	PSI	RPM
8.703-382.0	105924	TML-3053	24mm	5.3	3000	1450
8.703-457.0	106756	Pump Rail Set (Kit)				

NOTE: Can be run at 1750 RPM. Please note the pump ships without rails.



TTV

TTV SERIES:

- Heavy Industrial Triplex Plunger Pump with AI Connecting Rods
- 1450 RPM pulley drive with 24mm solid shaft, 3/4" inlet x 3/8" outlet, 31.9 lbs.
- Compare to: General Pumps — the TS series and AR Pumps — RK series.

Part No	Original No.	Model No.	Shaft	GPM	PSI	RPM
8.703-387.0	105954	TTV-3555	24mm	5.5	3500	1450

NOTE: Can be run at 1750 RPM. Please note the pump ships without rails.



KKV

KKV SERIES:

- Heavy Industrial Triplex Plunger Pump with AI Connecting Rods
- 1450 RPM and 1725 RPM pulley drive with 30mm solid shaft, 1" inlet x 1/2" outlet, 39.6 lbs.

Part No	Original No.	Model No.	Shaft	GPM	PSI	RPM
8.703-391.0	105962	KKV-3087	30mm	8.7	3000	1725

Please note the pump ships without rails.

Pump Rails

Part No	Original No.	Description
8.900-756.0	108762	Heavy Duty Pump Rail – Short (set)
8.900-757.0	108763	Heavy Duty Pump Rail – Tall (set)



Legacy Pumps – Direct Drive Units



WJG

WJG SERIES:

- Triplex Plunger Pump with Bronze Connecting Rods
- 3450 RPM direct drive with 3/4" hollow shaft and SAE flange, 3/8" inlet x 3/8" outlet, 13.2 lbs.
- Compare to: General Pumps — the TP series and AR Pumps — XTV series.

Part No	Original No.	Model No.	Shaft	GPM	PSI	RPM
8.703-342.0	105812	WJG-2525	3/4"H	2.5	2500	3450



WJH-F and WJH

WJH-F SERIES:

- Triplex Plunger Pump with Bronze Connecting Rods
- 3450 RPM direct drive with 5/8" hollow shaft and NEMA 56C flange, 3/8" inlet x 3/8" outlet, 13.2 lbs.
- Compare to: General Pumps — the TT series and AR Pumps — XTV series.

WJH SERIES:

- Triplex Plunger Pump with AI Connecting Rods
- 1725 RPM direct drive with 5/8" hollow shaft and NEMA 56C flange, 3/8" inlet x 3/8" outlet, 13.2 lbs.
- Compare to: General Pumps — the T & TT series and AR Pumps — XTA series.

Part No	Original No.	Model No.	Shaft	GPM	PSI	RPM
WJH-F						
8.703-346.0	105822	WJH-2525-F	5/8"H	2.5	2500	3450
WJH						
8.703-348.0	105830	WJH-2121	5/8"H	2.1	2100	1725
8.703-349.0	105832	WJH-2132	5/8"H	3.2	2100	1725



WMG

WMG SERIES:

- Premium Triplex Plunger Pump with Bronze Connecting Rods
- 3450 RPM direct drive with 3/4" hollow shaft and SAE flange, 1/2" inlet x 3/8" outlet, 14.7 lbs.
- Compare to: General Pumps — the TX series and AR Pumps — XMV series.

Part No	Original No.	Model No.	Shaft	GPM	PSI	RPM
8.703-351.0	105842	WMG-2530	3/4"H	3.0	2500	3450



PUMPS & PUMP KITS

Legacy Pumps – Direct Drive Units



WMG 1

WMG 1" SERIES:

- Premium Triplex Plunger Pump with Bronze Connecting Rods
- 3450 RPM direct drive with 1" hollow shaft and SAE flange, 1/2" inlet x 3/8" outlet, 14.7 lbs.
- Compare to: General Pumps — the TX series and AR Pumps — XMV series.

Part No	Original No.	Model No.	Shaft	GPM	PSI	RPM
8.703-356.0	105854	WMG-3540	1"H	4.0	3500	3450



TMH

TMH SERIES:

- Industrial Triplex Plunger Pump with AI Connecting Rods
- 1725 RPM direct drive with 1-1/8" hollow shaft and NEMA flange, 1/2" inlet x 3/8" outlet, 18.9 lbs.
- Compare to: General Pumps — the EZ series and AR Pumps — RKA series.

Part No	Original No.	Model No.	Shaft	GPM	PSI	RPM
8.703-375.0	105910	TMH-3035	1-1/8"H	3.5	3000	1725
8.703-376.0	105912	TMH-3040	1-1/8"H	4.0	3000	1725
8.703-377.0	105914	TMH-3050	1-1/8"H	5.0	3000	1725
8.703-378.0	105916	TMH-3055	1-1/8"H	5.5	3000	1725



Legacy Pump



Horizontal Pump

Part No	Shaft	GPM	PSI	RPM
8.920-004.0	3/4"	2.6	3000	3400

NOTE: Can be used to replace Comet pumps listed on page 75.

Vertical Pump

Part No	Shaft	GPM	PSI	RPM
8.919-886.0	7/8"	2.6	3000	3400 with Garden Hose Fitting Inlet
9.120-020.0	7/8"	2.6	3000	3400 without Garden Hose Fitting Inlet

Seal Kits

for **Legacy^{HD}**



Part No	Kit – Packing
8.725-355.0	U Seal, 15mm
8.725-357.0	U Seal, 18mm
8.725-359.0	U Seal, 15mm
8.725-361.0	U Seal, 18mm
8.725-363.0	U Seal, 20mm
8.725-365.0	U Seal, 25mm
9.804-493.0	U Seal, 18mm
8.916-322.0	U Seal, 20mm

Pump Valve Kits

for **Legacy^{HD}**



Part No	Kit Description
9.802-603.0	Valve Complete
9.802-604.0	Valve Complete
9.802-608.0	Valve Complete
9.803-936.0	Valve Complete

Complete Seal Kits

for **Legacy^{HD}**



Part No	Kit Description
8.725-354.0	15mm U Seal
8.725-356.0	18mm U Seal
8.725-358.0	15mm U Seal
8.725-360.0	18mm U Seal
8.725-362.0	20mm U Seal
8.725-364.0	25mm U Seal
8.725-358.0	15mm U Seal
9.804-492.0	18mm U Seal

Plunger Oil Seal Kits

for **Legacy^{HD}**



Part No	Kit Description
9.802-606.0	Kit, Plunger Oil Seals
9.802-609.0	Kit, Plunger Oil Seals
9.803-937.0	Kit, Plunger Oil Seals

Ceramic Plunger Kits



Part No	Kit Description
8.754-862.0	Kit, Plunger, 14mm
8.754-576.0	Kit, Plunger, 15mm
8.933-023.0	Kit, Plunger, 15mm
9.803-934.0	Kit, Plunger, 15mm
8.753-514.0	Kit, Plunger, 16mm
8.754-858.0	Kit, Plunger, 16mm
8.754-983.0	Kit, Plunger, 16mm
8.751-237.0	Kit, Plunger, 18mm
8.753-823.0	Kit, Plunger, 18mm
9.802-629.0	Kit, Plunger, 18mm
9.803-935.0	Kit, Plunger, 18mm
8.751-238.0	Kit, Plunger, 20mm
9.802-620.0	Kit, Plunger, 20mm
8.752-839.0	Kit, Plunger, 22mm
9.802-614.0	Kit, Plunger, 25mm
8.752-840.0	Kit, Plunger, 28mm

Pump Rails



Part No	Description
8.717-577.0	Heavy Duty Pump Rail
9.802-744.0	Mounting Bolts

Pump Selection Chart for Legacy HD Direct Drive Pump

Legacy^{HD}

Motor	Engine	Pump	Unloader	Nozzle	Description	GPM / PSI
9.802-339.0	2HP	3450rpm	8.904-933.0,	GE2020F.1	9.803-899.0, VBA35, Direct # 3	1.9 / 1500
9.804-517.0	2HP	1725rpm	8.904-934.0,	GE2020S.1	9.803-899.0, VBA35, Direct# 3	1.9 / 1500
9.802-340.0	3HP	3450rpm	8.904-936.0,	GE2825F.1	9.803-899.0, VBA35, Direct# 4	2.5 / 1600
8.715-090.0	3HP	1725rpm	8.916-560.0,	GE2825S.1	9.803-899.0, VBA35, Direct# 4	2.5 / 1600
9.802-341.0	5HP	3450rpm	8.904-938.0,	GE3525F.1	9.803-899.0, VBA35, Direct # 5	3.5 / 2000
12.0 cu in	6.5HP		8.904-967.,	GG2530G.1	9.803-899.0, VBA35, Direct # 3	2.5 / 2700
16.5 cu in	9HP		8.904-969.0,	GG3035G.1	9.803-899.0, VBA35, Direct # 3.5	3 / 3000
20.6 cu in	11HP		8.904-969.0,	GG3035G.1	9.803-899.0, VBA35, Direct # 3	2.8 / 3500
23.7 cu in	13HP		8.916-558.0,	GG3535G.1	9.803-899.0, VBA35, Direct # 3.5	3.3 / 3500
23.7 cu in	13HP		8.916-559.0,	GG4030G.1	9.803-899.0, VBA35, Direct # 4.5	3.9 / 3000
23.7 cu in	13HP		8.904-970.0,	GS3040G.2	8.715-483.0, VRT607, Remote # 3	3 / 4000
20.6 cu in	11HP		8.904-971.0,	GS3540G.2	9.803-900.0, VBA35, Direct# 4	3.5 / 3000
23.7 cu in	13HP		8.904-972.0,	GS4040G.2	8.715-483.0, VRT607, Remote # 4	4 / 4000
29.3 cu in	16HP		8.904-973.0,	GS5030G.2	9.803-900.0, VBA35, Direct# 5.5	4.8 / 3000

PUMPS & PUMP KITS

Legacy Pump Repair Kit Selection Chart



Pump Model	Check	Plunger Rod	Water Seal(s)	WaterSeal(s)	Valve		
Series	MM	Valve Kit	Oil Seal Kit	Only Kit	Brass Ring Kit	Cap Kit	Seal Kit
HDL	18	Kit 93	Kit 37	Kit 95	Kit 96	Kit 94	Kit 98
HG	15	Kit 84	Kit 64	Kit 129	Kit 92	Kit 66	N/A
KKV	22	Kit 40	Kit 37	Kit 90	Kit 87	Kit 132	Kit 98
KKV	25	Kit 40	Kit 37	Kit 91	Kit 88	Kit 100	Kit 98
KTV	20	Kit 123	Kit 37	Kit 89	Kit 86	Kit 99	Kit 98
TMG	15	Kit 123	Kit 65	Kit 74	Kit 69	Kit 67	Kit 78
TMH	18	Kit 123	Kit 65	Kit 76	Kit 71	Kit 67	Kit 78
TML	18	Kit 123	Kit 65	Kit 76	Kit 71	Kit 67	Kit 77
TML-F	15	Kit 123	Kit 65	Kit 74	Kit 69	Kit 67	Kit 77

Pump Model	Check	Plunger Rod	Water Seal(s)	WaterSeal(s)	Valve		
Series	MM	Valve Kit	Oil Seal Kit	Only Kit	Brass Ring Kit	Cap Kit	Seal Kit
TMS	18	Kit 123	Kit 65	Kit 76	Kit 71	Kit 67	Kit 77
TTV	20	Kit 123	Kit 37	Kit 89	Kit 86	Kit 67	Kit 127
WJG	15	Kit 84	Kit 64	Kit 60	Kit 61	Kit 66	Kit 82
WJH-F	15	Kit 84	Kit 64	Kit 60	Kit 61	Kit 66	Kit 82
WJH	18	Kit 84	Kit 64	Kit 12	Kit 10	Kit 66	Kit 82
WMG-3/4"	15	Kit 124	Kit 64	Kit 73	Kit 68	Kit 67	Kit 80
WMG-1"	15	Kit 124	Kit 64	Kit 73	Kit 68	Kit 67	Kit 79
WMH-F	15	Kit 124	Kit 64	Kit 73	Kit 68	Kit 67	Kit 80
WMH	18	Kit 63	Kit 64	Kit 12	Kit 70	Kit 67	Kit 80
WML	18	Kit 63	Kit 64	Kit 12	Kit 70	Kit 67	Kit 81

Legacy Pump Repair Tool Kit



9.802-954.0 pump repair tool kit shown.

Part No	Description
9.802-954.0	Legacy Pump Repair Tool Kit (For all models except GB, GP, GP1, GF)
8.756-590.0	Legacy Pump Repair Tool Kit For Normal Maintenance (For models: GB, GP, GP1 and HY)
8.756-717.0	Legacy Pump Repair Tool Kit For Oil Seal Maintenance (For models: GB, GP, GP1 and HY)

Part No	Description
9.802-564.0	Guide, Oil Seal Inserter, Plunger Rod GT-GX-GH
9.802-581.0	Piston, Oil Seal Inserter, Plunger Rod GT-GX-GH
9.802-580.0	Piston, Oil Seal Inserter, Plunger Rod GM-GD-GG-GE-GS
9.802-563.0	Guide, Oil Seal Inserter, Plunger Rod GM-GD-GG-GE-GS
9.802-571.0	Wrench, Allen 8mm, Manifold Bolts GT-GX-GH
9.802-567.0	Wrench, Allen 6mm, Manifold Bolts GM-GD-GG-GE-GS
9.802-570.0	Wrench, Allen 5mm, Crankcase Cover
9.802-565.0	Guide, Oil Seal Inserter, Crankshaft GT-GX-GH
9.802-566.0	Guide, Oil Seal Inserter, Crankshaft GM-GD-GG-GE-GS
9.802-568.0	Extractor, Piston Seal
9.802-579.0	Piston, Seal Inserter, Manifold GM-GS
9.802-573.0	Guide, Seal Inserter, Manifold GM-GS
9.802-578.0	Piston, Seal Inserter, Manifold GT
9.802-572.0	Guide, Seal Inserter, Manifold GT
8.751-396.0	Guide, Seal Inserter, Manifold GD-GE-GG
8.751-404.0	Guide, Seal Inserter, Manifold GX5050
8.751-397.0	Piston, Seal Inserter, Manifold GD-GE-GG-GH-GX
8.751-405.0	Guide, Seal Inserter, Manifold GH-GX
9.802-569.0	Hammer, Plastic Head
8.751-403.0	Screwdriver Flathead
9.802-574.0	Box, Plastic Tool Box

Legacy Pump Repair Kits



Part No	Original No.	Kit No.	Description	No. of Pieces	Qty Needed Per Pump
8.703-458.0	106810	Kit 10	WJH Packing / Header / Brass Assy (18mm)	21	1
8.703-459.0	106812	Kit 12	WM-H&L Packing Kit WJH Packing / Header only (18mm)	15	1
9.803-041.0	106822	Kit 22	APR.S Unloader Seal(s) Kit	14	1
8.703-461.0	106837	Kit 37	TTV-KTV-HDL Plunger Oil Seal Kit	3	1
8.703-462.0	106840	Kit 40	KKV Check Valves / O-ring Kit	12	1
8.932-979.0	106842	Kit 42	APR.S Unloader Valve Seal Kit	3	1
8.900-701.0	106860	Kit 60	V-Packing,15mm Legacy Pump WJH WJH-F&G Packing / Header only (15mm)	12	1
8.900-702.0	106861	Kit 61	Complete Plunger Set 15mm 18PX WJH-F&G Packing / Header / Brass (15mm)	18	1
8.703-464.0	106863	Kit 63	WMH&L Check Valve / O-ring Kit	12	1
8.703-465.0	106864	Kit 64	HG / WJ / WM Plunger Oil Seal Kit	3	1
8.703-466.0	106865	Kit 65	TM Plunger Oil Seal Kit	3	1
8.703-467.0	106866	Kit 66	HG / WJ Valve Cap / O-ring (M18x1.5) Kit	12	1
8.703-468.0	106867	Kit 67	WM / TM / TTV Valve Cap / O-ring (M27x1.5)	12	1
8.703-469.0	106868	Kit 68	WM-F&G Packing / Brass Assy Kit (15mm)	21	1
8.703-470.0	106869	Kit 69	TM-F&G Packing / Brass Assy (15mm)	21	1
8.703-471.0	106870	Kit 70	WM-H&L Packing / Brass Assy Kit (18mm)	21	1
8.703-472.0	106871	Kit 71	TM-H&L Packing / Brass Assy Kit (18mm)	24	1
8.703-456.0	106755	Kit 72	WML Pump Rail Kit (Foot, Spacer, Bolt)	8	1
8.703-474.0	106873	Kit 73	WM-F&G Packing Only Kit (15mm)	15	1
8.703-475.0	106874	Kit 74	TM-F &G Packing Only Kit (15mm)	15	1
8.703-476.0	106876	Kit 76	TM-H&L Packing Only Kit (18mm)	18	1
8.703-477.0	106877	Kit 77	TM-S&L Accessory Seals Kit	8	1
8.703-478.0	106878	Kit 78	TM-G Accessory Seals Kit	8	1
8.703-479.0	106879	Kit 79	WM-G 1" Accessory Seals Kit	8	1
8.703-480.0	106880	Kit 80	WM-F&G-3/4" Accessory Seals Kit	8	1
8.703-481.0	106881	Kit 81	WM-L Accessory Seals Kit	8	1
8.703-482.0	106882	Kit 82	WJH-F Accessory Seals Kit	8	1
8.703-483.0	106884	Kit 84	HG / WJ Check Valve / O-ring Kit	12	1
8.703-485.0	106886	Kit 86	TTV-KTV Packing / Brass Assy Kit (20mm)	24	1
8.703-486.0	106887	Kit 87	KKV Packing / Brass Assy Kit (22mm)	24	1
8.703-487.0	106888	Kit 88	KKV Packing / Brass Assy Kit (25mm)	24	1
8.703-488.0	106889	Kit 89	TTV-KTV Packing Only Kit (20mm)	18	1
8.703-489.0	106890	Kit 90	KKV Packing Only Kit L90 (22mm)	18	1
8.703-490.0	106891	Kit 91	KKV Packing Only Kit L91 (25mm)	18	1
8.703-491.0	106892	Kit 92	HG Packing / Brass Assy Kit	21	1
8.703-492.0	106893	Kit 93	HDL Check Valve / O-ring Kit	12	1
8.703-493.0	106894	Kit 94	HDL Valve Containment Kit L94	24	1
8.900-703.0	106895	Kit 95	HDL Packing Only Kit L95 (18mm)	18	1
8.703-494.0	106896	Kit 96	HDL Packing / Brass Assy Kit (18mm)	24	1
8.703-495.0	106898	Kit 98	KTV-KKV-HDL Accessory Seal Kit	8	1
8.703-496.0	106899	Kit 99	KTV Valve Cap / O-ring Kit (Plated)	12	1
8.703-497.0	106900	Kit 100	KKV Plated Valve Cap / O-ring Kit	12	1
8.703-498.0	106923	Kit 123	TM-TTV-KTV Check Valve / O-ring	12	1
8.703-499.0	106924	Kit 124	WM-F&G Check Valve / O-ring Kit	12	1
8.703-500.0	106926	Kit 126	APR-35/40 Seal Repair Kit	13	1
8.703-501.0	106927	Kit 127	TTV Accessory Oil Seal Kit	10	1
8.703-502.0	106929	Kit 129	HG Packing Only Kit (15mm)	12	1
8.703-503.0	106932	Kit 132	KKV Valve Cap / O-ring Kit	12	1

PUMPS & PUMP KITS

Admiral Pump Repair Kits

For the following Admiral pumps: WE Series; WEL Series; XD Series; XLS Series; CA Series; WG Series; XLE Series; XLG Series; C Series; IB Series

Part No.	Original No.	Kit No.	Description	Quantity Needed per Pump
8.900-631.0	106501	Kit AP1	Check Valves (For WE, WG, WEL, XL Series, XD Small Brass Head)	1
8.900-632.0	106502	Kit AP2	Brass Valve Covers (For WE, WG, WEL Series and XD Small Brass Head)	1
8.900-633.0	106504	Kit AP4	Oil Seals 15mm Plunger Rod (For WE, WG and WEL Series)	1
8.900-634.0	106505	Kit AP5	Oil Seals 18mm Plunger Rod (For XL Series)	1
8.900-635.0	106506	Kit AP6	Male Adapter Rings, 15mm (For WE and WG Series)	1
8.900-636.0	106507	Kit AP7	Male Adapter Rings, 18mm (For WEL, XLE and XLS Series)	1
8.900-637.0	106508	Kit AP8	V-Packing Seals, 15mm (For WE and WG Series)	1
8.900-638.0	106509	Kit AP9	V-Packing Seals, 18mm (For WEL Series Only)	1
8.900-639.0	106510	Kit AP10	Brass Packing Gland, 15mm (For WE and WG Series)	1
8.900-640.0	106511	Kit AP11	Brass Packing Gland, 18mm (For WEL Series)	1
8.900-641.0	106512	Kit AP12	Complete Plunger Seal, 15mm (For WE, and WG Series)	3
8.900-642.0	106513	Kit AP13	Complete Plunger Seal, 18mm (For WEL Series)	3
8.900-643.0	106514	Kit AP14	Brass Packing Gland, Two Piece, 18mm (For XLE, and XLS Series)	1
8.900-644.0	106515	Kit AP15	V-Packing Seals, Two Piece, 18mm (For XLE, and XLS Series)	1
8.900-645.0	106516	Kit AP16	Super U-Packing Seals, 18mm (For XLG Series Only)	1
8.900-646.0	106517	Kit AP17	Complete Plunger Seal, Two Piece, 18mm (For XLE, and XLS Series)	3
8.900-647.0	106518	Kit AP18	Complete Plunger Seal, Super-U, 18mm (For XLG Series Only)	3
8.900-648.0	106519	Kit AP19	Brass Packing Gland, Super-U, 18mm (For XLG Series Only)	1
8.900-649.0	106520	Kit AP20	Valve Covers, Brass (For XLG, XLE, XLS Series, and XD Small Plated Pump)	1
8.900-650.0	106521	Kit AP21	Valve Covers, Plated (For XLG, XLE, XLS, and XD Small Plated Pump)	1
8.900-651.0	106522	Kit AP22	Male Adapter Rings, 18mm (For XLG Series Only)	1
8.900-652.0	106523	Kit AP23	Low Pressure Seals, 18mm (For XL Series)	1
8.900-653.0	106524	Kit AP24	V-Packing Seals, 15mm, Two Piece (For WE-T and WG-T Series)	1
8.900-654.0	106525	Kit AP25	V-Packing Seals, 18mm, Two Piece (For WEL-T Series Only)	1
8.900-655.0	106526	Kit AP26	Brass Packing Gland, 15mm, Two Piece (For WE-T and WG-T Series)	1
8.900-656.0	106527	Kit AP27	Brass Packing Gland, 18mm, Two Piece (For WEL-T Series Only)	1
8.900-657.0	106528	Kit AP28	Complete Plunger Seal, 15mm, Two Piece (For WE-T, and WG-T Series)	3
8.900-658.0	106529	Kit AP29	Complete Plunger Seal, 18mm, Two Piece (For WEL-T Series Only)	3
8.900-659.0	106531	Kit AP31	Check Valve Kit (For XD Big Head)	1
8.900-660.0	106532	Kit AP32	Brass Valve Caps (For XD Big Head)	1
8.900-661.0	106533	Kit AP33	Plated Valve Caps (For XD Big Plated Head)	1
8.900-662.0	106534	Kit AP34	Plunger Rod Seal (For XD Pumps)	1
8.900-663.0	106535	Kit AP35	Male Adapter Rings (For XD 20mm)	1
8.900-664.0	106536	Kit AP36	Male Adapter Rings (For XD 22mm)	1
8.900-665.0	106537	Kit AP37	Male Adapter Rings (For XD 25mm)	1
8.900-666.0	106538	Kit AP38	"Super U" Packing (For XD 20mm)	1
8.900-667.0	106539	Kit AP39	"Super U" Packing (For XD 22mm)	1
8.900-668.0	106540	Kit AP40	"Super U" Packing (For XD 25mm)	1
8.900-669.0	106541	Kit AP41	Two Piece Brass Gland (For XD 20mm)	1
8.900-670.0	106542	Kit AP42	Two Piece Brass Gland (For XD 22mm)	1
8.900-671.0	106543	Kit AP43	Two Piece Brass Gland (For XD 25mm)	1
8.900-672.0	106544	Kit AP44	Complete Plunger Seal Repair (For XD 20mm)	3
8.900-673.0	106545	Kit AP45	Complete Plunger Seal Repair (For XD 22mm)	3
8.900-674.0	106546	Kit AP46	Complete Plunger Seal Repair (For XD 25mm)	3
8.900-675.0	106550	Kit AP50	Check Valve Kit (For C-Pumps, Brass Head)	1
8.900-676.0	106552	Kit AP52	Check Valve Assemblies (For IB-1000 Series, and CA Series)	1
8.900-678.0	106555	Kit AP55	Oil Seals, 45mm Plunger Rod (For IB-1000 Series, C and CA Series)	1
8.900-680.0	106557	Kit AP57	Male Adapter Rings, 45mm (For IB-1000 Series, C and CA Series)	1
8.900-682.0	106559	Kit AP59	V-Packing Seals, 45mm (For IB-1000 Series, C and CA Series)	1
8.900-683.0	106561	Kit AP61	Glands (45mm), Brass Packing (For IB-1019, 1032, 1037, C and CA Series)	1
8.900-685.0	106563	Kit AP63	Complete Plunger Seal, 45mm (For IB-1019, 1032, 1037, C and CA Series)	3
8.900-687.0	106566	Kit AP66	Packing Spacer Shim, 45mm (For IB-1000 / Shim)	1
8.900-691.0	106594	Kit AP94	Brass Packing Gland (30mm), (C-Series, 2200 PSI)	1
8.900-692.0	106595	Kit AP95	Complete Plunger Kit (30mm), (C-Series, 2200 PSI)	3
8.900-693.0	106596	Kit AP96	Male Adapter Kit (30mm), (C-Series, 2200 PSI)	1
8.900-694.0	106597	Kit AP97	V-Packing Kit (30mm), (C-Series, 2200 PSI)	1

Legacy HD Pump Repair Kit Selection Chart

for **Legacy^{HD}**

Use the selection chart below to find the correct repair kits for the specific Legacy HD Pump Model.

Pump Model	Seal Kit (qty per pump)	Complete Seal Kit (qty per pump)	Ceramic Plunger Kit (qty per pump)	Valve Kit (qty per pump)	Plunger Oil Seal Kit (qty per pump)
FOG0614R	-	8.754-575.0 (3)	8.754-576.0 (3)	8.754-577.0 (6)	8.754-578.0 (1)
FOG1214R	-	8.754-575.0 (3)	8.754-576.0 (3)	8.754-577.0 (6)	8.754-578.0 (1)
FOG1914R	-	8.754-575.0 (3)	8.754-576.0 (3)	8.754-577.0 (6)	8.754-578.0 (1)
FOG2514R	-	8.754-575.0 (3)	8.754-576.0 (3)	8.754-577.0 (6)	8.754-578.0 (1)
GB3030L	8.754-856.0 (1)	8.754-857.0 (3)	8.754-858.0 (3)	8.754-859.0 (1)	9.803-937.0 (1)
GB3030R	8.754-856.0 (1)	8.754-857.0 (3)	8.754-858.0 (3)	8.754-859.0 (1)	9.803-937.0 (1)
GB4025L	8.754-856.0 (1)	8.754-857.0 (3)	8.754-858.0 (3)	8.754-859.0 (1)	9.803-937.0 (1)
GB4025R	8.754-856.0 (1)	8.754-857.0 (3)	8.754-858.0 (3)	8.754-859.0 (1)	9.803-937.0 (1)
GD3025	8.725-356.0 (1)	8.725-357.0 (3)	9.803-935.0 (3)	9.803-936.0 (1)	9.803-937.0 (1)
GD3030	8.725-354.0 (1)	8.725-355.0 (3)	9.803-934.0 (3)	9.803-936.0 (1)	9.803-937.0 (1)
GD4020.1	8.725-356.0 (1)	8.725-357.0 (3)	9.803-935.0 (3)	9.803-936.0 (1)	9.803-937.0 (1)
GE2020F.1	8.725-354.0 (1)	8.725-355.0 (3)	9.803-934.0 (3)	9.803-936.0 (1)	9.803-937.0 (1)
GE2020S.1	8.725-356.0 (1)	8.725-357.0 (3)	9.803-935.0 (3)	9.803-936.0 (1)	9.803-937.0 (1)
GE2825F.1	8.725-354.0 (1)	8.725-355.0 (3)	9.803-934.0 (3)	9.803-936.0 (1)	9.803-937.0 (1)
GE2825S.1	8.725-356.0 (1)	8.725-357.0 (3)	9.803-935.0 (3)	9.803-936.0 (1)	9.803-937.0 (1)
GE3525F.1	8.725-354.0 (1)	8.725-355.0 (3)	9.803-934.0 (3)	9.803-936.0 (1)	9.803-937.0 (1)
GF2030F	8.754-860.0 (1)	8.754-861.0 (3)	8.754-862.0 (3)	8.754-859.0 (1)	9.803-937.0 (1)
GF2030S	8.754-856.0 (1)	8.754-857.0 (3)	8.754-858.0 (3)	8.754-859.0 (1)	9.803-937.0 (1)
GF2830F	8.754-860.0 (1)	8.754-861.0 (3)	8.754-862.0 (3)	8.754-859.0 (1)	9.803-937.0 (1)
GF2830S	8.754-856.0 (1)	8.754-857.0 (3)	8.754-858.0 (3)	8.754-859.0 (1)	9.803-937.0 (1)
GF3530F	8.754-860.0 (1)	8.754-861.0 (3)	8.754-862.0 (3)	8.754-859.0 (1)	9.803-937.0 (1)
GG2530G.1	8.725-354.0 (1)	8.725-355.0 (3)	9.803-934.0 (3)	9.803-936.0 (1)	9.803-937.0 (1)
GG3030G.1	8.725-354.0 (1)	8.725-355.0 (3)	9.803-934.0 (3)	9.803-936.0 (1)	9.803-937.0 (1)
GG3035G1.1	8.725-354.0 (1)	8.725-355.0 (3)	9.803-934.0 (3)	9.803-936.0 (1)	9.803-937.0 (1)
GG3535G1.1	8.725-354.0 (1)	8.725-355.0 (3)	9.803-934.0 (3)	9.803-936.0 (1)	9.803-937.0 (1)
GG4030G1.1	8.725-354.0 (1)	8.725-355.0 (3)	9.803-934.0 (3)	9.803-936.0 (1)	9.803-937.0 (1)
GH5050	9.804-492.0 (1)	9.804-493.0 (3)	9.802-629.0 (3)	9.802-604.0 (1)	9.802-606.0 (1)
GM3540.2	8.725-358.0 (1)	8.725-359.0 (3)	8.933-023.0 (3)	9.802-603.0 (1)	9.802-609.0 (1)
GM3540.3	8.725-358.0 (1)	8.725-359.0 (3)	8.933-023.0 (3)	9.802-603.0 (1)	9.802-609.0 (1)
GM4030.2	8.725-362.0 (1)	8.725-363.0 (3)	9.802-620.0 (3)	9.802-603.0 (1)	9.802-609.0 (1)
GM4030.3	8.725-362.0 (1)	8.725-363.0 (3)	8.751-238.0 (3)	9.802-603.0 (1)	9.802-609.0 (1)
GM4035.2	8.725-360.0 (1)	8.725-361.0 (3)	9.802-629.0 (3)	9.802-603.0 (1)	9.802-609.0 (1)
GM4035.3	8.725-360.0 (1)	8.725-361.0 (3)	8.751-237.0 (3)	9.802-603.0 (1)	9.802-609.0 (1)
GM5030.2	8.725-362.0 (1)	8.725-363.0 (3)	9.802-620.0 (3)	9.802-603.0 (1)	9.802-609.0 (1)
GM5030.3	8.725-362.0 (1)	8.725-363.0 (3)	8.751-238.0 (3)	9.802-603.0 (1)	9.802-609.0 (1)
GM6035.2	8.725-360.0 (1)	8.725-361.0 (3)	9.802-629.0 (3)	9.802-603.0 (1)	9.802-609.0 (1)
GM6035.3	8.725-360.0 (1)	8.725-361.0 (3)	8.751-237.0 (3)	9.802-603.0 (1)	9.802-609.0 (1)
GP2535G	8.754-860.0 (1)	8.754-861.0 (3)	8.754-862.0 (3)	8.754-859.0 (1)	9.803-937.0 (1)
GP3035G	8.754-860.0 (1)	8.754-861.0 (3)	8.754-862.0 (3)	8.754-859.0 (1)	9.803-937.0 (1)
GP3035G1	8.754-860.0 (1)	8.754-861.0 (3)	8.754-862.0 (3)	8.754-859.0 (1)	9.803-937.0 (1)
GP3535G1	8.754-860.0 (1)	8.754-861.0 (3)	8.754-862.0 (3)	8.754-859.0 (1)	9.803-937.0 (1)
GP4035G1	8.754-860.0 (1)	8.754-861.0 (3)	8.754-862.0 (3)	8.754-859.0 (1)	9.803-937.0 (1)
GS3040G.2	8.725-358.0 (1)	8.725-359.0 (3)	8.933-023.0 (3)	9.802-603.0 (1)	9.802-609.0 (1)
GS3040G.3	8.725-358.0 (1)	8.725-359.0 (3)	8.933-023.0 (3)	9.802-603.0 (1)	9.802-609.0 (1)
GS3540G.2	8.725-358.0 (1)	8.725-359.0 (3)	8.933-023.0 (3)	9.802-603.0 (1)	9.802-609.0 (1)
GS3540G.3	8.725-358.0 (1)	8.725-359.0 (3)	8.933-023.0 (3)	9.802-603.0 (1)	9.802-609.0 (1)
GS4040G.2	8.725-358.0 (1)	8.725-359.0 (3)	8.933-023.0 (3)	9.802-603.0 (1)	9.802-609.0 (1)
GS4040G.3	8.725-358.0 (1)	8.725-359.0 (3)	8.933-023.0 (3)	9.802-603.0 (1)	9.802-609.0 (1)
GS5030G.2	8.725-358.0 (1)	8.725-359.0 (3)	8.933-023.0 (3)	9.802-603.0 (1)	9.802-609.0 (1)

PUMPS & PUMP KITS

Pump Model	Seal Kit (qty per pump)	Complete Seal Kit (qty per pump)	Ceramic Plunger Kit (qty per pump)	Valve Kit (qty per pump)	Plunger Oil Seal Kit (qty per pump)
GS5030G.3	8.725-358.0 (1)	8.725-359.0 (3)	8.933-023.0 (3)	9.802-603.0 (1)	9.802-609.0 (1)
GT4540.2L	8.753-821.0 (1)	8.753-822.0 (3)	8.753-823.0 (3)	8.753-824.0 (1)	8.752-835.0 (1)
GT4540.2R	8.753-821.0 (1)	8.753-822.0 (3)	8.753-823.0 (3)	8.753-824.0 (1)	8.752-835.0 (1)
GT5635.1	8.916-488.0 (1)	8.916-322.0 (3)	9.802-607.0 (3)	9.802-603.0 (1)	9.802-606.0 (1)
GT5636.2L	8.753-821.0 (1)	8.753-822.0 (3)	8.753-823.0 (3)	8.753-824.0 (1)	8.752-835.0 (1)
GT5636.2R	8.753-821.0 (1)	8.753-822.0 (3)	8.753-823.0 (3)	8.753-824.0 (1)	8.752-835.0 (1)
GT6036.2L	8.753-821.0 (1)	8.753-822.0 (3)	8.753-823.0 (3)	8.753-824.0 (1)	8.752-835.0 (1)
GT6036.2R	8.753-821.0 (1)	8.753-822.0 (3)	8.753-823.0 (3)	8.753-824.0 (1)	8.752-835.0 (1)
GX1025.1	8.725-364.0 (1)	8.725-365.0 (3)	9.802-614.0 (3)	9.802-608.0 (1)	9.802-606.0 (1)
GX1036.2L	8.752-844.0 (1)	8.752-850.0 (3)	8.752-839.0 (3)	8.752-853.0 (1)	8.752-835.0 (1)
GX1036.2R	8.752-844.0 (1)	8.752-850.0 (3)	8.752-839.0 (3)	8.752-853.0 (1)	8.752-835.0 (1)
GX1622.2L	8.752-845.0 (1)	8.752-851.0 (3)	8.752-840.0 (3)	8.717-589.0 (1)	8.752-835.0 (1)
GX1622.2R	8.752-845.0 (1)	8.752-851.0 (3)	8.752-840.0 (3)	8.717-589.0 (1)	8.752-835.0 (1)
GX5450L	8.753-512.0 (1)	8.753-513.0 (3)	8.753-514.0 (3)	8.753-515.0 (1)	8.752-835.0 (1)
GX5450R	8.753-512.0 (1)	8.753-513.0 (3)	8.753-514.0 (3)	8.753-515.0 (1)	8.752-835.0 (1)
GX8030.1	8.725-364.0 (1)	8.725-365.0 (3)	9.802-614.0 (3)	9.802-608.0 (1)	9.802-606.0 (1)
GX9536.2L	8.752-844.0 (1)	8.752-850.0 (3)	8.752-839.0 (3)	8.752-853.0 (1)	8.752-835.0 (1)
GX9536.2R	8.752-844.0 (1)	8.752-850.0 (3)	8.752-839.0 (3)	8.752-853.0 (1)	8.752-835.0 (1)
HFR105SL	8.754-245.0 (1)	8.754-244.0 (3)	8.754-242.0 (3)	8.754-243.0 (1)	8.754-235.0 (6)
HFR105SR	8.754-245.0 (1)	8.754-244.0 (3)	8.754-242.0 (3)	8.754-243.0 (1)	8.754-235.0 (1)
HFR120SL	8.754-245.0 (1)	8.754-244.0 (3)	8.754-242.0 (3)	8.754-243.0 (1)	8.754-235.0 (1)
HFR120SR	8.754-245.0 (1)	8.754-244.0 (3)	8.754-242.0 (3)	8.754-243.0 (1)	8.754-235.0 (1)
HFR40FL	8.754-231.0 (1)	8.754-232.0 (3)	8.754-233.0 (3)	8.754-243.0 (1)	8.754-235.0 (1)
HFR40FR	8.754-231.0 (1)	8.754-232.0 (3)	8.754-233.0 (3)	8.754-243.0 (1)	8.754-235.0 (1)
HFR40SL	8.754-231.0 (1)	8.754-232.0 (3)	8.754-233.0 (3)	8.754-243.0 (1)	8.754-235.0 (1)
HFR40SR	8.754-231.0 (1)	8.754-232.0 (3)	8.754-233.0 (3)	8.754-243.0 (1)	8.754-235.0 (1)
HFR60FL	8.754-231.0 (1)	8.754-232.0 (3)	8.754-233.0 (3)	8.754-243.0 (1)	8.754-235.0 (1)
HFR60FR	8.754-231.0 (1)	8.754-232.0 (3)	8.754-233.0 (3)	8.754-243.0 (1)	8.754-235.0 (1)
HFR60SL	8.754-231.0 (1)	8.754-232.0 (3)	8.754-233.0 (3)	8.754-243.0 (1)	8.754-235.0 (1)
HFR60SR	8.754-231.0 (1)	8.754-232.0 (3)	8.754-233.0 (3)	8.754-243.0 (1)	8.754-235.0 (1)
HFR80FL	8.754-231.0 (1)	8.754-232.0 (3)	8.754-233.0 (3)	8.754-234.0 (1)	8.754-235.0 (1)
HFR80FR	8.754-231.0 (1)	8.754-232.0 (3)	8.754-233.0 (3)	8.754-234.0 (1)	8.754-235.0 (1)
HFR80SL	8.754-245.0 (1)	8.754-244.0 (3)	8.754-242.0 (3)	8.754-243.0 (1)	8.754-235.0 (1)
HFR80SR	8.754-245.0 (1)	8.754-244.0 (3)	8.754-242.0 (3)	8.754-243.0 (1)	8.754-235.0 (1)
HHP25SL	8.754-236.0 (1)	8.754-237.0 (3)	8.754-246.0 (1)	8.754-241.0 (1)	8.754-235.0 (1)
HHP25SR	8.754-236.0 (1)	8.754-237.0 (3)	8.754-246.0 (1)	8.754-241.0 (1)	8.754-235.0 (1)
HHP2750R	8.754-236.0 (1)	8.754-240.0 (3)	8.754-246.0 (1)	8.754-247.0 (1)	8.754-235.0 (1)
HHP30SL	8.754-236.0 (1)	8.754-237.0 (3)	8.754-246.0 (1)	8.754-241.0 (1)	8.754-235.0 (1)
HHP30SR	8.754-236.0 (1)	8.754-237.0 (3)	8.754-246.0 (1)	8.754-241.0 (1)	8.754-235.0 (1)
HHP3650L	8.754-236.0 (1)	8.754-240.0 (3)	8.754-246.0 (1)	8.754-247.0 (1)	8.754-235.0 (1)
HHP3650R	8.754-236.0 (1)	8.754-240.0 (3)	8.754-246.0 (1)	8.754-247.0 (1)	8.754-235.0 (1)
HHP38FL	8.754-236.0 (1)	8.754-237.0 (3)	8.754-246.0 (1)	8.755-233.0 (1)	8.754-235.0 (1)
HHP38FR	8.754-236.0 (1)	8.754-237.0 (3)	8.754-246.0 (1)	8.755-233.0 (1)	8.754-235.0 (1)
HHP4150L	8.754-236.0 (1)	8.754-240.0 (3)	8.754-246.0 (1)	8.754-247.0 (1)	8.754-235.0 (1)
HHP4150R	8.754-236.0 (1)	8.754-240.0 (3)	8.754-246.0 (1)	8.754-247.0 (1)	8.754-235.0 (1)
HHP5040L	8.754-236.0 (1)	8.754-240.0 (3)	8.754-246.0 (1)	8.754-247.0 (1)	8.754-235.0 (1)
HHP5040R	8.754-236.0 (1)	8.754-240.0 (3)	8.754-246.0 (1)	8.754-247.0 (1)	8.754-235.0 (1)
HHP5750L	8.754-236.0 (1)	8.754-240.0 (3)	8.754-246.0 (1)	8.754-247.0 (1)	8.754-235.0 (1)
HY1515	8.754-979.0 (1)	8.754-981.0 (3)	8.754-983.0 (1)	8.754-577.0 (1)	9.803-937.0 (1)
HY1520	8.754-980.0 (1)	8.754-982.0 (3)	8.754-983.0 (1)	8.754-577.0 (1)	9.803-937.0 (1)
NMT1520CWR	8.754-239.0 (1)	8.754-229.0 (3)	8.754-261.0 (1)	8.754-276.0 (6)	8.754-261.0 (1)
NMT1520SCWR	8.754-239.0 (1)	8.754-229.0 (3)	8.754-261.0 (1)	8.754-276.0 (6)	8.754-261.0 (1)
NMT2120CWR	8.754-239.0 (1)	8.754-229.0 (3)	8.754-261.0 (1)	8.754-276.0 (6)	8.754-261.0 (1)
NMT2120ESR	8.754-239.0 (1)	8.754-229.0 (3)	8.754-256.0 (1)	8.754-230.0 (6)	8.754-261.0 (1)

Interpump / General Pumps



8.756-267.0, General Pumps

General Pumps

Part No	Model No.	GPM	PSI	Shaft RPM	Shaft Size
8.756-267.0	ET1809E17	3.2	2320	1700	5/8"
8.756-268.0	ET1509E17	2.1	2610	1700	5/8"
8.756-270.0	ET1504E34	1.85	2610	3400	5/8"
8.756-271.0	ET1505E34	2.1	2610	3400	5/8"
8.756-272.0	ET1507E34	3.2	2610	3400	5/8"
8.756-273.0	ET1506G6	2.9	2610	3400	3/4"
8.756-274.0	ET1507G6	3.2	2610	3400	3/4"
8.756-276.0	EP1810E17	3.4	2500	1750	1-1/8"
8.756-277.0	EP1812E17	4.0	2500	1750	1-1/8"
8.756-283.0	EP1512E17	2.9	3045	1750	1-1/8"
8.756-287.0	ES2012S	4.76	4000	1750	24mm
8.756-288.0	ES2013S	5.55	3600	1750	24mm



8.702-629.0, Solid-Shaft Pumps

Solid-Shaft Pumps

Part No	Old No	Interpump	Model No.	GP Model No.	GPM	PSI	RPM	Shaft Dia
8.702-629.0	102048	WS92	TS921		4.75	1800	1450	24mm
9.802-358.0	102052	W99	T991		3.5	1500	1450	24mm
8.702-625.0	102046	W92	T921		5.0	1700	1050	24mm
8.702-622.0	102042	WS82	TS821		5.6	1500	1450	24mm
8.702-636.0	102058	WS101	TS1011		4.0	2000	1450	24mm
8.702-635.0	102056	W101	T1011		4.5	2000	1125	24mm
8.702-646.0	102076	WS133	TS1331		3.5	2100	1450	24mm
8.702-645.0	102074	WS132	TS1321		4.75	2100	1450	24mm
8.702-643.0	102072	W132	T1321		5.5	2100	1150	24mm
8.702-650.0	102084	WS151	TSS1511s		4.0	3500	1450	24mm
8.702-649.0	102082	W151	T1511		4.5	2500	1125	24mm
8.702-655.0	102090	WS162	TS1621		4.75	2500	1450	24mm
8.702-654.0	102088	W162	T1621		5.0	2500	1050	24mm
8.702-665.0	102105	W201	T2011		4.5	3000	1125	24mm
8.702-667.0	102110	WS201	TS2011		4.0	3000	1450	24mm
8.702-670.0	102115G	WS202	TS2021		5.6	3500	1450	24mm
8.702-697.0	102157	W972	T9721		2.1	1000	1750	24mm
8.702-700.0	102167	W979	T9791		2.5	1100	1750	24mm
8.702-701.0	102170	W995	T9951		3.4	1300	1750	24mm
8.702-702.0	102174	W996	T9961		4.0	1100	1750	24mm
8.702-703.0	102176	W997	T9971		4.0	2000	1750	24mm
8.702-686.0	102135	W912	T9121		4.75	1500	1750	24mm
8.702-687.0	102140	W913	T9131		4.0	1900	1750	24mm
8.702-688.0	102145	W916	T9161		4.75	2300	1750	24mm
8.702-690.0	102150	W921	T9211		4.0	2900	1750	24mm
8.702-693.0	102152	W928	T9281		4.0	4000	1750	24mm
8.702-695.0	102154	T5050	T5050		5.0	5000	1845	24mm
8.702-661.0	102097	-	TT9111		3.0	1500	1750	24mm
8.702-630.0	102049	WW93	TT931		2.9	1500	2800	24mm
8.702-628.0	102047	WW94	TT941		3.43	1300	2800	24mm
8.702-685.0	102134	WW935	TT9351		3.5	2500	3400	24mm
8.702-663.0	102102	WW944	TT9441		4.4	2500	3400	24mm

*Duplex Pump



8.702-635.0



8.702-703.0

Interpump / General Pumps



TX Solid-Shaft Pump

Part No	Old No	Model No.	GPM	PSI	RPM	Shaft Dia
8.702-741.0	102282	TX1510S34	4.0	3000	3400	24MM

8.702-741.0, TX Solid-Shaft Pumps



Series "44" (EZ Series) Solid-Shaft Pumps

Part No	Old No	Interpump Model No.	GP Model Model No.	GPM	PSI	RPM	Shaft Dia
8.702-766.0	102313	W956	EZ2536S	3.6	2500	1750	24mm
8.702-768.0	102317	W959	EZ2542S	4.2	2500	1750	24mm
8.702-773.0	102320	W186	EZ3040S	4.0	3000	3400	24mm
8.702-782.0	102333	-	EZ4040S34	4.0	4000	3400	24mm

NOTE: For Direct-Drive Mounting of the above pumps. See flanges on page 115.

8.702-768.0, Series "44" Solid-Shaft Pumps



TSF

Part No	Old No	Model No.	GPM	PSI	RPM	Shaft Dia
8.702-740.0	102281	TSF2021	7.0	3600	1450	24mm
8.702-736.0	102277	TSF2221	10.2	3000	1750	24mm
8.702-737.0	102278	TSF2421	12.0	2500	1750	24mm

8.702-740.0, TSF Pumps



Large Frame Solid-Shaft Pumps

Part No	Old No	Interpump Model No.	GP Model No.	GPM / PSI	RPM	Shaft Dia
8.702-612.0	102004	W4A	T41A	12.0 / 900	650	35mm
8.702-640.0	102067	WS104	TS1041	8.0 / 1600	1450	35mm
8.702-652.0	102086	WS153	TS1531	8.0 / 2175	1450	35mm
8.702-648.0*	102079	WS135	TS1351	11.0 / 2000	1450	32mm
8.702-657.0	102092	W163	T1631	10.0 / 2500	1080	32mm
8.702-672.0	102120	W203	T2031	9.0 / 3000	1140	32mm
8.702-613.0	102006	W6	T61	17.0 / 1000	650	35mm
8.702-614.0	102008	W8	T81	21.0 / 1000	650	35mm
8.740-164.0	102012	W12	T121	35.0 / 1000	650	35mm

* Double-headed pump

8.702-652.0, Large Frame, Solid-Shaft Pumps



Solid-Shaft Car Wash Pumps

Part No	Old No	Model No.	GPM	PSI	RPM	Shaft Dia	Ship Wt (lbs)
8.702-754.0	102295	CW2040	5.0	2500	1250	24mm	30
8.702-752.0	102293	CW24	5.0	2500	1250	24mm	30
8.702-745.0	102286	CW3040	5.0	3000	1250	24mm	32
8.702-748.0	102289	CW81	20.0	1200	1000	35mm	92

8.702-754.0, Solid-Shaft Car Wash Pumps

Interpump / General Pumps



8.702-711.0, Gas Hollow-Shaft, Direct-Drive Pumps

Gas Hollow-Shaft Direct-Drive

Part No	Old No	Interpump Model No.	GP Model No.	GPM / PSI	RPM	Shaft Dia
8.702-711.0	102206	WW906G	TT9061G	2.1 / 1400	3400	3/4"
8.702-712.0	102208	WW907G	TT9071G	2.8 / 1500	3400	3/4"
8.702-682.0	102130		TT1540GBF	4.0 / 1500	3400	3/4"
8.702-673.0	102121		TT2028GBF	2.8 / 2000	3400	3/4"
8.702-674.0	102122		TT2035GBF	3.5 / 2000	3400	3/4"



Hollow-Shaft Direct-Drive — flanged for direct couple to electric motors

Part No	Old No	Interpump Model No.	GP Model No.	GPM / PSI	RPM	Shaft Dia
8.702-708.0	102202	W905E	T9051E	2.1 / 1400	1750	5/8"
8.702-710.0	102204	WW906E	TT9061E	2.1 / 1400	3400	5/8"
8.702-713.0	102210	WW907E	TT9071E	2.8 / 1500	3400	5/8"
8.702-677.0	102125		TT9111EBF	3.0 / 1500	1750	5/8"
8.702-679.0	102126		TT2021EBF	2.1 / 2000	3400	5/8"
8.702-680.0	102127		TT2028EBF	2.8 / 2000	3400	5/8"
8.702-681.0	102129		TT2035EBF	3.5 / 2000	3400	3/4"



EZ Series Hollow-Shaft Direct-Drive — flanged for direct couple to gasoline engines

Part No	Old No	Interpump Model No.	GP Model No.	GPM / PSI	RPM	Shaft Dia
8.702-764.0	102309	WW961EZG	EZ3040G	4.0 / 2500	3400	1"
8.702-776.0	102324		EZ4030G34	3.0 / 4000	3400	1"
8.702-778.0	102326		EZ4035G34	3.5 / 4000	3400	1"
8.702-779.0	102327		EZ4040G34	4.0 / 4000	3400	1"

EZ Series Hollow-Shaft — flanged for direct couple to electric motors

Part No	Old No	Interpump Model No.	GP Model No.	GPM / PSI	RPM	Shaft Dia
8.702-758.0	102301	W956EZE	EZ2536E	3.6 / 2500	1750	1-1/8"
8.702-759.0	102303	W959EZE	EZ2542E	4.2 / 2500	1750	1-1/8"
8.702-761.0	102305	W950EZE	EZ2545E	4.5 / 2500	3400	1-1/8"
8.702-760.0	102304	W953EZE	EZ2555E	5.5 / 2500	3400	1-1/8"
8.702-780.0	102330	-	EZ4035E	3.5 / 4000	3400	1-1/8"



TX Series Hollow-Shaft Direct-Drive — flanged for direct couple to 184TC electric motor

Part No	Old No	Model No.	GPM / PSI	RPM	Shaft Dia
8.702-784.0	102335	TX1810E179	3.2 / 2000	1750	1-1/8"
8.702-785.0	102336	TX1812E179	3.8 / 2000	1750	1-1/8"

Interpump / General Pump Kit Selection Chart



Use this selection chart to find the correct repair kit for the specific Interpump / General Pump model.

Pump Model	Valves	Oil Seal	Piston Packings	Packing w/Brass	Ceramic	Valve Caps	Piston Bolts	Head Rings	Crank Oil Seal
TX1510S34	Kit 123	Kit 159	Kit 160	Kit 166	104800	Kit 124	–	–	–
TX1810E179	Kit 123	Kit 159	Kit 161	Kit 167	104804	Kit 124	–	–	–
TX1812E179	Kit 123	Kit 159	Kit 161	Kit 167	104804	Kit 124	–	–	–
TSF2021	Kit 169	Kit 2	Kit 170	Kit 171	083900	–	–	–	Kit 3
TSF2221	Kit 169	Kit 2	Kit 172	Kit 173	107921	–	–	–	Kit 3
TSF2421	Kit 169	Kit 2	Kit 181	Kit 182	107923	–	–	–	Kit 3
T9721	Kit 1	Kit 23	Kit 19	Kit 27	104809	Kit 4	Kit 6	Kit 21	104641
T9731	Kit 1	Kit 23	Kit 19	Kit 27	104809	Kit 4	Kit 6	Kit 21	104637
T731	Kit 1	Kit 23	Kit 19	Kit 27	104809	Kit 4	Kit 6	Kit 21	104641
T991	Kit 1	Kit 23	Kit 19	Kit 27	104809	Kit 4	Kit 6	Kit 21	104641
T9951	Kit 1	Kit 23	Kit 19	Kit 27	104809	Kit 4	Kit 6	Kit 21	104641
T9971	Kit 1	Kit 23	Kit 19	Kit 27	104809	Kit 4	Kit 6	Kit 21	104641
T921	Kit 1	Kit 2	Kit 148	Kit 29	104805	Kit 4	Kit 6	Kit 11	Kit 3
T1011	Kit 1	Kit 2	Kit 69	Kit 28	104803	Kit 4	Kit 6	Kit 7	Kit 3
T1321	Kit 1	Kit 2	Kit 148	Kit 29	104805	Kit 4	Kit 6	Kit 11	Kit 3
T9211	Kit 1	Kit 2	Kit 69	Kit 28	104803	Kit 5	Kit 6	Kit 7	Kit 3
T9281	Kit 1	Kit 2	Kit 109	Kit 112	104808	Kit 106	Kit 107	Kit 108	Kit 3
T4251	Kit 122	Kit 44	Kit 77	Kit 78	104810	–	–	Kit 7	Kit 32
T5050	Kit 150	Kit 2	Kit 109	Kit 151	104808	–	–	Kit 108	Kit 3
TS1021	Kit 1	Kit 2	Kit 69	Kit 28	104803	Kit 4	Kit 6	Kit 7	Kit 3
TS1011	Kit 1	Kit 2	Kit 69	Kit 28	104803	Kit 4	Kit 6	Kit 7	Kit 3
TS1041	Kit 62	Kit 37	Kit 69	Kit 82	104803	–	Kit 54	Kit 7	Kit 32
TS1321	Kit 1	Kit 2	Kit 148	Kit 29	104805	Kit 4	Kit 6	Kit 11	Kit 3
TS1511	Kit 1	Kit 2	Kit 69	Kit 28	104803	Kit 4	Kit 6	Kit 7	Kit 3
TS1531	Kit 62	Kit 37	Kit 69	Kit 82	104803	–	Kit 54	Kit 7	Kit 32
TS2011	Kit 1	Kit 2	Kit 69	Kit 28	104803	Kit 5	Kit 6	Kit 7	Kit 3
TS2021	Kit 1	Kit 2	Kit 69	Kit 28	104803	Kit 5	Kit 6	Kit 7	Kit 3
TT9111	Kit 1	Kit 83	Kit 141	Kit 140	104806	Kit 84	–	–	104641
TT941	Kit 1	Kit 83	Kit 97	Kit 96	083807	Kit 84	–	–	104641
TT9441	Kit 1	Kit 23	Kit 88	Kit 92	104800	Kit 4	–	–	104641
TT2028	Kit 1	Kit 83	Kit 97	Kit 96	083807	Kit 84	–	–	104637
TT2035	Kit 1	Kit 83	Kit 97	Kit 96	083807	Kit 84	–	–	104637
TT9061	Kit 1	Kit 83	Kit 97	Kit 96	083807	Kit 84	–	–	104637
TT9071	Kit 1	Kit 83	Kit 97	Kit 96	083807	Kit 84	–	–	104637
EZ2542E	Kit 123	Kit 23	Kit 127	Kit 131	104804	Kit 124	–	Kit 129	104649
EZ2545E	Kit 123	Kit 23	Kit 88	Kit 130	104800	Kit 124	–	Kit 90	104649
EZ3035G	Kit 123	Kit 23	Kit 88	Kit 130	104800	Kit 124	–	Kit 90	104649
EZ3040G	Kit 123	Kit 23	Kit 88	Kit 130	104800	Kit 124	–	Kit 90	104649
EZ3040S	Kit 123	Kit 23	Kit 88	Kit 130	104800	Kit 124	–	Kit 90	104644
T9051EBF	Kit 1	Kit 83	Kit 97	Kit 96	104800	Kit 84	–	–	104644
EZ2542S	Kit 123	Kit 23	Kit 127	Kit 131	104804	Kit 124	–	Kit 129	104644
EZ3042S	Kit 123	Kit 23	Kit 127	Kit 131	104804	Kit 124	–	Kit 129	104644
EZ4040S34	Kit 123	Kit 23	Kit 153	Kit 156	104812	Kit 124	–	Kit 155	104644
EZ3030G34	Kit 123	Kit 23	Kit 88	Kit 130	104800	Kit 124	–	Kit 90	104649
EZ3045G	Kit 123	Kit 23	Kit 88	Kit 130	104800	Kit 124	–	Kit 90	104649
EZ4035G34	Kit 123	Kit 23	Kit 153	Kit 156	104812	Kit 124	–	Kit 155	104649
TS1331-B	Kit 1	Kit 2	Kit 69	Kit 28	104803	Kit 4	Kit 6	Kit 7	Kit 3
T1631	Kit 1	Kit 24	Kit 148	Kit 28	104805	Kit 4	Kit 6	Kit 11	–
CW1012	Kit 62	Kit 37	Kit 113	Kit 67	104813	–	Kit 74	Kit 65	Kit 32

Genuine Interpump / General Pump Kits



We stock a complete selection of original Interpump / General Pump repair kits. See previous page for our kit selection chart.

- Complete selection of repair kits
- See page 112 for our version of these kits for a lower-cost alternative.

Part No	Old No	Kit No.
8.702-798.0	103001G	Kit1, Valve
8.702-800.0	103002B	Kit2, Piston, Rod Oil Seal
8.702-801.0	103003B	Kit3, Crankshaft Oil Seal
8.702-802.0	103004B	Kit4, Valve Cap
8.702-803.0	103005B	Kit5, Valve Cap
8.702-805.0	103006B	Kit6, Piston Bolt
8.702-806.0	103007B	Kit7, Head Ring
8.702-116.0	103008B	Kit8HP old style, 20mm Packing
8.702-115.0	1-0008	Kit8, new style
8.900-442.0	103008LP	Kit8 Old Style, Packing Kit
8.900-444.0	103009X	Kit9 Packing Spacer
8.702-809.0	103010B	Kit10, Retainer, 20mm Packing
8.702-810.0	103011B	Kit11, 22mm Head Ring
8.702-811.0	103012B	Kit12, 22mm Packing
8.702-812.0	103014B	Kit14, Retainer, 22mm Packing
8.702-813.0	103015B	Kit15 Packing Adapter
8.702-814.0	103015B	Kit16, 24mm Packing
8.702-815.0	103017B	Kit17, 24mm, Intermed. Ring
8.702-816.0	103018B	Kit18 Packing Retainer
8.702-817.0	103019B	Kit19, 20mm HP Packing
8.702-818.0	103019NB	Kit19 new style
8.702-820.0	103020B	Kit20, 20mm, Intermed. Ring
8.702-821.0	103021B	Kit21, 20mm Head Ring
8.702-822.0	103022B	Kit22, 20mm, Packing Retainer
8.702-823.0	103023B	Kit23, Piston, Rod Oil Seal
8.702-824.0	103024B	Kit24, Piston, Rod Oil Seal
8.702-825.0	103026B	Kit26, Piston Bolt
8.702-826.0	103027B	Kit27, 20mm, Packing Assy
8.702-829.0	103028NB	Kit28, 20mm, Packing Assy
8.702-830.0	103029NB	Kit29, 22mm, Packing Assy
8.702-833.0	103032B	Kit32, Crankshaft, Oil Seal
8.702-834.0	103037B	Kit37, Piston, Rod Oil Seal
8.702-836.0	103038NB	Kit38, 36mm Packing
8.702-838.0	103041B	Kit41, Packing Adapter
8.702-840.0	103044B	Kit44, Piston, Rod Oil Seal
8.702-843.0	103050B	Kit50, Valve Kit

Part No	Old No	Kit No.
8.702-844.0	103051B	Kit51, Timax Maintenance
8.702-847.0	103058B	Kit58, K5 Maint.
8.702-849.0	103060B	Kit60, K5, Complete Reblid
8.702-850.0	103061B	Kit61, K3, Complete Reblid
8.702-851.0	103062B	Kit62, Valve
8.702-852.0	103063B	Kit63, 30mm Packing
8.702-853.0	103064B	Kit64, Packing with Intermed. Rings
8.702-854.0	103065B	Kit65 30MM, Head Ring
8.702-855.0	103066B	Kit66, Packing Spacer
8.702-856.0	103067B	Kit67, 30mm, Packing Assy
8.702-857.0	103069NB	Kit69, 20mm, Packing w/Restop
8.702-858.0	103070B	Kit70, K7 Maint.
8.702-859.0	103071B	Kit71, Intermed. Ring w/Restop
8.702-860.0	103072B	Kit72, Maint. Kit
8.702-861.0	103074B	Kit74, Piston Bolt
8.702-864.0	103077B	Kit77, 20mm, Packing w/Restop
8.900-484.0	103080B	Kit80, 45mm, Packing Assy
8.702-870.0	103081B	Kit81, Intermed. Ring
8.702-872.0	103083B	Kit83, Oil Seal
8.702-873.0	103084B	Kit84, Valve Cap
8.702-874.0	103085B	Kit85, Complete Packing
8.702-875.0	103086B	Kit86, Packing Retainer
8.702-876.0	103087B	Kit87, Packing
8.702-877.0	103088NB	Kit88, Packing, EZ3040G
8.702-878.0	103089B	Kit89, Intermed. Ring
8.702-879.0	103090B	Kit90, Head Ring
8.702-880.0	103091B	Kit91, Packing Retainer
8.702-882.0	103092NB	Kit92, Piston Seal
8.702-883.0	103093B	Kit93, Control Set W2
8.702-884.0	103094B	Kit94, Control Set
8.702-885.0	103095B	Kit95, KR Unloader
8.702-886.0	103096B	Kit96, Packing Assy
8.702-887.0	103097B	Kit97, Packing
8.702-888.0	103098B	Kit98, ZKW1 Maint.
8.702-961.0	103220B	Kit100, Hot Kit, 190° Water, (Replaces Kits #1 and #28)

Genuine Interpump / General Pump Kits, continued



We stock a complete selection of original Interpump / General Pump repair kits. See previous page for our kit selection chart.

Part No	Old No	Kit No.
8.702-893.0	103102B	Kit102, Unloader Maint.
8.702-896.0	103105B	Kit105,P10 Maint.
8.702-897.0	103106B	Kit106, Valve Cap
8.702-898.0	103107B	Kit107,Piston Bolt, Pump T9281
8.702-899.0	103108B	Kit108, Head Ring for T-9281
8.702-900.0	103109NB	Kit109, 16 mm, Packing New
8.702-901.0	103110B	Kit110, 16mm, Intermed. Ring
8.702-902.0	103111B	Kit111, Packing, Retainer, 16mm, Pump T9281
8.702-903.0	103112B	Kit112, 16mm, Packing Assy
8.702-904.0	103113B	Kit113, Packing Assy
8.702-908.0	103118B	Kit118, Packing
8.702-909.0	103119B	Kit119, Packing
8.702-910.0	103120B	Kit120, Unloader
8.702-912.0	103122B	Kit122, Valves
8.702-913.0	103123B	Kit123, Valve, EZ3040
8.702-914.0	103124B	Kit124, Valve Cap and O-Ring for EZ Pump
8.702-915.0	103125B	Kit125, EZ Pump
8.702-917.0	103127B	Kit127, Packing, EZ2542S
8.702-919.0	103129B	Kit129, Head Ring, EZ Series
8.702-920.0	103130B	Kit 130 Packing Complete
8.702-921.0	103131B	Kit131, EZ Pump
8.702-923.0	103134B	Kit134, Valve TH Pump
8.702-928.0	103140B	Kit140, Packing, Assembly, T9111
8.702-929.0	103141B	Kit141, General
8.702-930.0	103148B	Kit148, 22mm Packing
8.702-931.0	103149B	Kit149, Ring, Intermediate
8.702-932.0	103150B	Kit150, Valve, General T5050
8.702-933.0	103151B	Kit151, Packing Retainer
8.702-934.0	103153B	Kit153, Packing Kit

Part No	Old No	Kit No.
8.702-936.0		Kit156 13mm Packing
8.702-937.0	103159B	Kit159 Oil Seal
8.702-938.0		Kit160 Short Packing
8.702-939.0	103161B	Kit161 Packings
8.702-940.0	103162B	Kit162 Packings
9.841-673.0		Kit163 Seal Retainer
8.702-941.0	103164B	Kit164 Int Ring
9.841-638.0	103165B	Kit165 Int Ring
8.702-942.0	103166B	Kit166 Long Kit1
8.702-943.0		Kit167 Packing Assy
8.702-945.0	103169B	Kit169 Valve Kit
8.702-946.0	103170B	Kit170LP Seal Kit and HP Seal
8.702-947.0	103171B	Kit171 Packings
8.702-948.0	103172B	Kit172 Low/High Packing
8.702-949.0	103173B	Kit173 Packings, Kit176 and Kit180
8.702-952.0		Kit176, 18mm Packing
8.702-953.0		Kit180, 18mm Packing
8.702-954.0	103181B	Kit181 LP Seal Kit and HP Seal
8.702-955.0	103182B	Kit182 Packings, Kit196 and Kit197
8.702-956.0		Kit196, 15mm HP Packing
8.702-957.0		Kit197, 18mm HP Packing
8.702-958.0	103201B	Kit201 Valve Kit
8.702-959.0		Kit202 Packing Kit
8.723-898.0		Kit203 Seals
8.702-960.0		Kit204 Seals
8.723-512.0		Kit212
8.702-962.0		Kit226, 15mm packing

AR Triplex Ceramic Plunger Pumps



8.702-585.0

Direct-Drive Gas Engine Flanged Models

Part No	Old No	Model No.	GPM	PSI	RPM	Shaft Dia	Weight (lbs)
8.702-552.0	101804	XTV3G16D-F7	3.0	1600	3400	3/4"	10
8.702-494.0	101701	XTV3G22D-F7	3.0	2200	3400	3/4"	11
8.702-501.0	101718	XMV25G26D-F25	2.5	2600	3400	3/4"	19
8.702-498.0	101711	XMV3G30D-F24	3.0	3000	3400	1"	19
8.702-495.0	101702	XMV3G25D-F25	3.0	2500	3400	3/4"	19
8.702-546.0	101796	XMV35G25D-F24	3.5	2500	3400	1"	19
8.702-542.0	101792	XMV35G25D-F25	3.5	2500	3400	3/4"	19
8.702-547.0	101797	XMV4G30D-F24	3.8	3000	3400	1"	19
8.702-585.0	101865	RKV35G30AD-F24	3.5	3000	3400	1"	21
8.702-586.0	101866	RKV4G30AD-F24	4.0	3000	3400	1"	21
8.702-587.0	101867	RKV4G32D-F24	4.0	3200	3400	1"	21
8.702-588.0	101868	RKV4G35HD-F24	4.0	3500	3400	1"	21



8.702-513.0

Solid-Shaft Models

Part No	Old No	Model No.	GPM	PSI	RPM	Shaft Dia	Weight (lbs)
8.702-506.0	101731	XTA3G22N	3.0	2200	1750	24mm	11
8.702-507.0	101734	XTA3G19N	3.0	1900	1750	24mm	11
8.715-307.0	101780	XMA3.5G25N	3.5	2500	1750	24mm	18
8.702-590.0	101870	RKA4G20N	4.0	2000	1750	24mm	19
8.702-593.0	101873	RKA4G30N	4.0	3000	1750	24mm	19
8.702-597.0	101877	RKA4G40HN	4.0	4000	1750	24mm	21
8.702-520.0	101765	XW2128N	5.5	4060	1450	24mm	34
8.702-513.0	101750	XW2623	6.87	3400	1450	24mm	34



8.702-504.0

Direct-Drive Electric Flanged Models

Part No	Old No	Model No.	GPM	PSI	RPM	Shaft Dia	Weight (lbs)
8.702-504.0	101730	XTA2G15E	2.1	1500	1750	5/8"	9
8.702-550.0	101801	XTV2G15EBA-F8	2.1	1500	3400	5/8"	10
8.702-551.0	101803	XTV3G16E-F8	3.0	1600	3400	5/8"	10
8.702-508.0	101737	XTV3G20E-F8	3.0	2000	3400	5/8"	11
8.702-500.0	101717	XTV3G22E-F8	3.0	2200	3400	5/8"	11
8.702-515.0	101756	XTA3G22E-F8	3.0	2200	1750	5/8"	11
8.702-514.0	101755	XTA3G16EBA-F8	3.0	1600	1750	5/8"	10
8.702-591.0	101871	RKA4G20E-F17	4.0	2000	1750	1-1/8"	21
8.702-592.0	101872	RKA4G30E-F17	4.0	3000	1750	1-1/8"	21

AR Pump Repair Kit Selection Chart



Use the following chart to find AR Repair Kits by pump model number. See next page for AR kit part numbers. We also stock a broad selection of non-kit AR repair parts.

Pump Model	Water Seals	Check Valves	Oil Seals	Piston Kit	Piston Guide	Support Rings	Hot Kit
XJV	AR002798	AR001864	AR002797	AR002796	AR1980180 ea	AR1980190 ea	-
XJW	AR002800	AR001864	AR002797	AR002796	AR1980180 ea	AR1980190 ea	-
XT-15MM	AR001866	AR001864	AR001872-N ver AR002725-H/D	AR002628	AR1260151 ea	AR1520120 ea	AR002029-V
XT-18MM	AR001874	AR001864	AR001872-N ver AR002726-H/D	AR002629	AR1260450 ea	AR1320340 ea	AR002030-V
XTA-15MM	AR001866	AR001864	AR001860-E ver	AR002628	AR1260151 ea	AR1520120 ea	AR002029-V
XTA-18MM	AR001874	AR001864	AR001860-E ver	AR002629	AR1260450 ea	AR1320340 ea	AR002030-V
XTV	AR001866	AR001864	AR001860-D, E ver AR001872-N ver	AR002628 AR002725-H/D	AR1260151 ea	AR1520120 ea	AR002029-V
XM-15MM	AR002741	AR001864	AR002786-N ver AR1780100 ea R	AR002544	AR1780090 ea F	AR002740	AR002776
XM-18MM	AR002747	AR001864	AR002786-N ver AR1780120 ea R	AR002545	AR1780110 ea F	AR002745	AR002777
XMA-15MM	AR002741	AR001864	AR002786-N ver AR1780100 ea R	AR002544	AR1780090 ea F	AR002740	AR002776
XMA-18MM	AR002747	AR001864	AR002786-N ver AR002787-E ver AR1780120 ea R	AR002545	AR1780110 ea F	AR002745	AR002777
XMV	AR002741	AR001864	AR002786-N ver AR002787-D ver AR1780100 ea R	AR002544	AR1780090 ea F	AR002740	AR002776
XRC-18MM	AR001857	AR001828	AR001855- N ver	AR002546	AR1380090 ea	AR001829	AR002809
XRC-20MM	AR001887	AR001828	AR001855- N ver	AR002547	AR1380150 ea	AR001815	AR002810
XRCA-18MM	AR001857	AR001828	AR001855- N ver AR001856-E ver	AR002546	AR1380090 ea	AR001829	AR002809
XRCA-20MM	AR001887	AR001828	AR001855- N ver AR001856-E ver	AR002547	AR1380150 ea	AR001815	AR002810
XRCV	AR001857	AR001828	AR001856-D, E ver	AR002546	AR1380090 ea	AR001829	AR002809
RK-18MM	AR001857	AR002864	AR001855-N ver	AR002546	AR1380090 ea	AR001829	AR002809
RK-20MM	AR001887	AR002864	AR001855-N ver	AR002547	AR1380150 ea	AR001815	AR002810
RKA-18MM	AR001857	AR002864	AR001855-N ver	AR002546	AR1380090 ea	AR001829	AR002809
RKA-20MM	AR001887	AR002864	AR001855-N ver	AR002547	AR1380150 ea	AR001815	AR002810
RKV	AR001857	AR001828	AR001856	AR002546	AR1380090 ea	AR001829	AR002809
XW-20MM	AR002782	AR002780	AR002781	AR002650	AR002784	-	AR002778
XW-22MM	AR002783	AR002780	AR002781	AR001891	AR002785	-	AR002779
XWA-20MM	AR002782	AR002780	AR002781	AR002650	AR002784	-	AR002778
XWA-22MM	AR002783	AR002780	AR002781	AR001891	AR002785	-	AR002779
SXW-18MM	AR002874	AR002871	AR002873	AR002548	AR002875	-	-

AR Pump Kits



Original factory-direct repair kits. See previous page for kit selection chart. Don't see what you're looking for? Give us a call. We stock a broad selection of AR replacement parts. AR piston kits contain all that you need to repair broken pistons, O-rings, washers, nuts, plungers...YOU GET IT ALL!



Part No	Old No	Kit Description
8.720-573.0	AR001804	Packing
8.720-574.0	AR001805	Packing, 20mm
8.740-118.0	AR001806	Pump
8.720-575.0	AR001815	Piston
8.720-578.0	AR001825	Valve Kit
8.720-579.0	AR001826	Piston Bolt
8.720-581.0	AR001828	Valve
8.720-582.0	AR001829	Ring, Support, XRA / XRV*
8.720-583.0	AR001830	Repair, AR 2882, O-Rings Only
8.720-585.0	AR001842	Piston, XRA / XRV*
8.720-586.0	AR001843	Piston, XRA, XR
8.720-592.0	AR001855	Oil Seal, XRA*
8.720-593.0	AR001856	Oil Seal, XRV
8.720-594.0	AR001857	Packing, XRA / XRV*
8.720-596.0	AR001860	Seal, Oil, XTV*
8.720-597.0	AR001864	Valve Kit
8.720-598.0	AR001865	Oil Seal
8.720-599.0	AR001866	Water Seals
8.720-601.0	AR001869	Repair Unloader
8.720-602.0	AR001872	Oil Seal
8.720-603.0	AR001873	Oil Seal Kit Cmplt
8.720-604.0	AR001874	Packing

*Series

Part No	Old No	Kit Description
8.720-606.0	AR001887	Water Seals
8.720-611.0	AR002031	Viton Seal, XRA
8.720-612.0	AR002043	Oil Seal
8.720-613.0	AR002044	Seal
8.720-632.0	AR002544	Piston, XM*
8.720-633.0	AR002546	Piston XRCA / XRCV
8.720-643.0	AR002624	Seal
8.720-644.0	AR002628	AR Piston #2628
8.720-649.0	AR002697	Repair, Combi-Set
8.720-651.0	AR002740	Support Ring, XM*
8.720-652.0	AR002741	Water Seal, XM*
8.720-655.0	AR002747	Packing, XMA* 18MM
8.720-658.0	AR002776	Hot / Dry Cup
8.720-661.0	AR002780	Valve, XWA8G30N-SX
8.720-662.0	AR002781	Seal, XWA8G30N-SX
8.720-663.0	AR002782	Piston Seal, XWA8G30N-SX
8.720-665.0	AR002784	Piston Guide, XWA8G30N-SX
8.720-667.0	AR002786	Oil Seals, XMA35G25N
8.720-668.0	AR002787	Oil Seals
8.720-684.0	AR002864	Valve Kit, RK*

*Series

Comet Pumps and Pump Kits



For use in homeowner or light commercial-duty pressure washer.



- One-piece bronze connection rods
- Built-in unloader
- Increased surface area for lower operating temperatures
- Ultra high-pressure head

Part No	Old No	Model No.	GPM	PSI	RPM	Shaft Dia
9.802-357.0	5-2107	AXD 2020 E	1.9	2000	3400	5/8" (Hollow)
8.702-576.0	101850	AXD 3020 G	2.75	2000	3400	3/4" (Shaft) (Belt Drive)
8.715-286.0	830160	AXD 2427 G	2.5	2700	3400	3/4" (Hollow)
8.750-238.0		BXD 2020 E	1.9	2000	3400	5/8" (Hollow)

Comet kits and parts are available for any Comet model. Call with model number for quick and accurate service.



Part No	Old No	Model No.
8.721-902.0	CT0202002000	Piston 15MM FWD
8.721-903.0	CT0202002200	Piston 18MM FWD
8.718-556.0	CT5019003500	Seal Kit LWD HP
8.721-979.0	CT5019003800	Packing Kit FWS / FWD
8.721-985.0	CT5019004500	Seal Kit Oil LW Series Hollow
8.721-986.0	CT5019006400	Seal Kit ZWD4030G
8.721-987.0	CT5019006500	Seal Kit Hollow Shaft Pumps
8.721-989.0	CT5019007800	Seal Kit AXD2020
8.721-988.0	CT5019007700	Seal Kit AXD3020
8.750-711.0		Seal Kit BXD2020 E
8.721-996.0	CT5025001100	Valve Kit ZWD / FWS / FWD / HW / FW / LW
8.721-997.0	CT5025001400	Valve Kit AXD 3020
8.725-562.0		Valve Kit BXD2020

PUMPS & PUMP KITS

Ceramic Plungers

Precision-ground, high-polish, solid ceramic plungers, designed for long life even under constant use.



Part No	Old No	General Pump Part No	Size
8.703-185.0	104798	51040109	18mm
8.703-187.0	104800	52040009	15mm, EZ Series
8.703-188.0	104801	46040009	For W50 Pump
8.703-190.0	104803	47040409	20mm
8.703-191.0	104804	44040109	18mm, EZ Series
8.703-192.0	104805	47040509	22mm
8.900-575.0	104806	51040166	18mm, TP Series
8.703-193.0	104807	47040609	24mm Solid, Ceramic
8.703-194.0	104808	47040856	16mm, 47 Series
8.703-195.0	104809	50040409	20mm, T Series 49
8.703-196.0	104810	61040056	20mm, 76 & 77 Series
8.703-197.0	104811	69040009	36mm
8.703-198.0	104812	44040266	13mm, EZ Series
8.703-199.0	104813	69040109	30mm
8.703-200.0	104815	76040209	45mm
8.703-767.0	107921	66040109	22mm, TSF2221
8.703-768.0	107923	66040409	24mm
8.701-400.0			15mm, T21

Packing and Seal Kits

UPC, General Pump and Interpump replacement kits. Time-tested, quality parts meet or exceed factory specifications.



Part No	Old No	Description
8.900-438.0	103001X	Kit 1, Check Valve
8.900-440.0	103002X	Kit 2, Oil Seal
8.900-441.0	103003X	Kit 3, Crankshaft Oil Seal
8.900-442.0	103008LPX	Kit 8, New Style packing Kit
8.900-443.0*	103008X	Kit 8, V-Packing
8.900-444.0*	103009X	Kit 9, Intermed Packing
8.900-447.0*	103012X	Kit 12, V-Packing
8.900-456.0*	103019X	Kit 19, V-Packing
8.900-463.0	103023X	Kit 23, Crankcase Oil Seal
8.900-464.0	103024X	Kit 24, Crankcase Oil Seal
8.900-466.0*	103027X	Kit 27, Plunger Repair
8.900-468.0*	103028X	Kit 28, Plunger Repair
8.900-471.0*	103029X	Kit 29, Plunger Repair
8.900-476.0	103037X	Kit 37, Oil Seal
8.900-485.0	103083X	Kit 83, Oil Seal
8.900-488.0	103087X	Kit 87, V-Packing
8.900-492.0	103097X	Kit 97, Packing

*These are old style kits to replace components in Interpump / General pumps with two brown Buna-V packings (pumps built before the change was made to restop ring and black low-pressure seals.)

Piston Pumps

- Cast-iron body
- Stainless-steel check valves
- Complete with base or torque arm
- Buna cups
- 140° max temperature except 5321
- 180° max temperature 5321
- 1/2 NPT ports



HYPRO

8.702-156.0

Part No	Old No	Hypro	GPM	PSI	RPM
Solid Shaft					
8.702-155.0	100314	5315	1.5	500	1750
8.702-158.0	100319	5320	2.0	500	1750
8.702-161.0	100322	5321	2.2	1000	1750
8.702-163.0	100325	5324	2.9	800	1750
8.702-167.0	100331	5330	3.0	500	1750
Hollow Shaft					
8.702-156.0	100315	5315	1.5	500	1750
8.702-157.0*	100316	5315	1.5	500	1750
8.702-159.0	100320	5320	2.0	500	1750
8.702-160.0	100321	5321	2.2	1000	1750
8.702-162.0	100324	5324	2.9	800	1750
8.702-164.0	100326	5325	2.5	500	1750
8.702-166.0	100330	5330	3.0	500	1750
8.702-146.0	100301	Injector Head 5320 / 5330 Pump			
8.702-152.0	100306	Injector Head 5321 / 5324 Pump			

*Has Teflon seals

Pump Parts and Tools

For 5300 series pump.



Valve Seat Tools



Piston Repair Kit

HYPRO



Valve Cage Tools

- A necessity for working on 5300 series pumps
- Rugged construction

Part No	Old No	Description
8.722-629.0	H34300010	Piston Repair Kit (Model 5320 pump)
8.722-634.0	H34300144	Piston Repair Kit (Model 5321 pump)
8.722-641.0	H34300197	Check Valve Kit (All 5300 Pumps)
8.712-510.0	449052	Valve Cage Tool
8.712-512.0	449071	Valve Seat Tool

NOTE: Piston Repair Kits have Buna seal

Jetter Pulse Valves

Replaces valve cap to create pulsation action, to move nozzle in pipe cleaning applications.

Legacy



Part No	Old No	Description
8.755-228.0		For Legacy GB/GF/GP Series
8.755-229.0		For Legacy GM Series / GS Series
8.755-230.0		For Legacy GT Series
8.755-231.0		For Legacy GX Series, 4350 PSI
8.755-232.0		For Legacy GX Series, 3000 PSI
8.712-249.0	410317	For GP 47 Series Pumps
8.712-250.0	410318	For GP TT Pumps

Accumulator by Interpump



Pulse dampener.

- 3/4" MPT connector
- 1350 PSI max pressure
- 10 GPM max flow
- Weight 1 lb



Part No	Old No	Description
8.711-148.0	381110	Accumulator

Accumulator – Pulse Dampener

- 180°F max temperature
- Precharge pressure 580 PSI



8.711-145.0 8.711-147.0

Part No	Old No	Working PSI	Capacity	Inlet
8.711-145.0	381102	3100	21.4 CU"	1/2" F
8.711-146.0	381103	3100	6.1 CU"	3/8" F
8.711-147.0	381104	4400	2.5 CU"	3/8" F

Packing Extractor

Virtually unbreakable sockets will pull packings from Interpump, General and other brand pumps.

Easy to use: Slide-Hammer (shown below) attaches to slotted socket—which expands inside the packing gland. The slide hammer then pops the packing gland brass out of the head to facilitate easy seal repairs without damage to brass support rings.



Part No	Old No	Description
Slide Hammer		
8.712-513.0	449299	Hammer Only
Sockets for Regular Slide Hammer		
8.712-516.0	449302	18mm Socket
8.712-515.0	449301	15mm Socket
8.712-517.0	449303	20mm Socket
8.712-518.0	449304	22mm Socket
8.712-520.0	449307	25mm Socket
Large Slide Hammer		
8.712-521.0	449309	Large Slide Hammer
Sockets for Large Slide Hammer		
8.712-523.0	449311	30mm Socket
8.712-524.0	449312	38mm Socket
8.712-525.0	449313	45mm Socket

V-Packing Insertion Tool Kit

Contains inserting tools for installing 20mm, 22mm and 24mm V-packings in the packing gland. Prevents damaged sealing surfaces.



Part No	Old No	Description
8.712-519.0	449305	V-Packing Kit

Interpump Packing Extractor Tool



Expansion tool inserts into packing gland to remove lodged packing components.



Part No	Old No	Description
8.712-522.0	449310	Extractor (only)
Expansion Sockets for Extractor Above		
8.712-526.0	449315	15mm (Ref Kit 86 and 97)
8.712-528.0	449320	20mm (Ref Kit 8 and 19)
8.712-529.0	449322	22mm (Ref Kit 12)
8.712-530.0	449324	24mm (Ref Kit 16)

NOTE: 15mm Expansion Sockets also fit Admiral Pump W-Series pumps.

O-Ring Tool

Indispensable for Pump Repair. Excellent for removing O-rings, seals, etc.

- 6" long dental pick
- Stainless-steel
- Knurled handle
- Double-end



Part No	Old No	Description
8.707-467.0	249737	Dental Pick
9.802-568.0	959260	Pliers, Seal Extractor

Pump Oil

Quality mineral base lubricating oil ideal for use in high pressure piston precision plunger pumps. Blended with wear, rust, and foam inhibitors.



Part No	Description
8.923-425.0	Pump Oil 10W40 (quart)

Pump Lube

- A premium-quality lubricating oil fortified with additives to reduce friction, foaming and corrosion
- Ideal for use in heavy industrial applications requiring hydraulic based lubricant



Part No	Old No	Description
8.756-854.0	112056	Pump Lube (quart)
9.808-016.0	112076	Case Lot (qty 12)

General Pump GL5 80w-90 Gear Lube



General Pump gear lube is a multi-viscosity SAE 80W 90 lubricant with anti-friction, anti-foaming and corrosion-inhibitor additives. Use in Admiral Geared Speed Reducers and Interpump / General RS99, RS151, PTO as well as other high-speed gear boxes.



Part No	Description
8.756-728.0	Gear lube (2-1/2 gallons)

PUMPS & PUMP KITS

Complete Pump Extraction Kit

- 13mm, 15mm, 18mm, 20mm, 22mm and 24mm sockets
- 13mm-24mm in a carrying case
- Slide hammer

Part No	Description
8.723-619.0	Extraction Kit



Geared Reduction

Specifically designed for Legacy and Admiral pumps.

- Engine-to-pump drive units
- 2.1 to 1 reduction ratio (3,675 Eng. RPM=1,750 Pump RPM)
- Engine shaft size = 0.984" or 1" or 1-1/8"

Legacy



Part No	Old No	Description
8.710-332.0	349120	24mm Pump x 1" Engine
8.710-333.0	349121	30mm Pump x 1" Engine
8.710-334.0	349122	30mm Pump x 1-1/8" Engine
8.715.344.0		25mm Pump x 1" Engine
8.715-342.0		24mm Pump x 1" Engine
8.749-925.0		24mm Pump x 0.984" Engine
8.749-922.0		24mm Pump x 3/4" Engine
8.749-923.0		24mm Pump x 1" Engine
8.749-336.0		24mm Pump x 1-1/8" Engine
8.754-767.0		25mm Pump x 1-1/8" Engine

Geared Reduction

Fits Admiral, Interpump, AR, Comet, Udor, and Hawk.

- Engine-to-pump drive units
- 2.18 to 1 reducer
- For 11-18 HP gasoline engine
- For pumps with a 24mm shaft



Part No	Old No	Description
8.710-335.0	349130	1" Engine Shaft
8.710-336.0	349131	1-1/8" Engine Shaft

Anti-Seize Compound

Recommended for all metal-to-metal, power-drive assemblies. Facilitates removal after use.

- Copper-graphite or nickel
- Copper-graphite high-torque for high temperature to 1800°F
- Nickel continues to work up to 2400°F
- Stops rust, galling and seizure on pulley / shaft or gear / shaft interfaces



Part No	Old No	Description
8.704-638.0	112299	Blister Pack (1 appl) Copper – Graphite
8.704-641.0	112305	8 oz Brush Top Can – Nickel

Geared Reduction Units Interpump / General



For use with 1,450 RPM Interpump, General Pumps and Admiral A-W99.

RS99: 2.4:1 Gear Reduction (3,480 engine RPM = 1,450 RPM Pump) For 3-5 HP Briggs, Honda-Tecumseh-Kohler with 3/4" shaft

RS151: 2.2:1 Gear Reduction (3,190 engine RPM = 1,450 RPM pump) For 7-18 HP Briggs, Honda engines with 1" or 1-1/8" shaft (must specify) Use with the appropriate size: "WS" series Interpump, "TS" series General pump

- Eliminates belts, pulleys and belt guards
- Engine-to-pump drive units
- Improve efficiency



Part No	Old No	Engine Shaft
RS-99		
8.710-321.0	349009	3/4"
RS-151		
8.710-322.0	349011	1"
8.710-324.0	349013	1-1/8"

8.710-321.0



8.710-322.0

PTO Geared Multiplier

- 1 to 1.9 speed multiplier
- 1-3/8" splined shaft (same shaft as standard tractor PTO)
- 540 RPM PTO speed multiplied to 1,026 RPM at pump shaft
- For pumps with a 24mm shaft



Part No	Old No	Description
8.710-319.0	349005	Gear Multiplier

Pumptech Pump

The Pumptech Pump is a Twin plunger design Originally used on the HOTSY Model Sport 500.

- 2 GPM max
- 1000 PSI max

Part No	Old No	Description
8.715-240.0	830065	Pump-Sport 500
8.707-369.0	753170	Crankshaft
8.707-370.0	753168	Seal Kit w/ plunger
8.700-187.0	753169	Check Valve Kit

Flanges

Direct attachment of Legacy Pumps to NEMA Standard C-Face Motors.



Part No	NEMA Frame	Pump Series
8.754-098.0	184 TC / 215 TC	GM
8.754-099.0	184 TC / 215 TC	GT-GX

Flex Couplers

Pump shaft couplers. Direct-drive self-adjusting resilient coupling Legacy pumps to NEMA Standard Motor Shafts.



Part No	NEMA-C Frame	Pump Series	Motor Drive Coupling
8.754-100.0	184 TC	GM	1-1/8" x 24 mm
8.754-101.0	215 TC	GM	1-3/8" x 24 mm
8.754-102.0	184 TC	GT-GX	1-1/8" x 25 mm
8.754-103.0	215 TC	GT-GX	1-3/8" x 25 mm

Flanges

Direct attachment of Interpump / General Pumps to NEMA Standard C-Face Motors.



Part No	Old No	NEMA Frame	Pump Frame Size
8.709-613.0	336020	56 / 145TC	W973
8.709-615.0	336024	184TC*	W995
8.709-616.0	336025	215TC**	W913
8.709-870.0	339120	8-13 HP(G)	WW161

*W995 / GD **W913 / GM

Flex Couplers

24mm pump shaft couplers. Direct-drive flex coupling 24mm Interpump / General and Admiral XLS Series pumps to NEMA Standard Motor Shafts.



Part No	Old No	NEMA Frame	Drive Shaft
2-Piece Coupler			
8.709-617.0	336028	56 A	5/8"
8.709-619.0	336030	145 T	7/8"
8.709-621.0	336032	184 T	1-1/8"
8.709-624.0	336036	215 T	1-3/8"
8.709-869.0	339112A	Gas (Aluminum)	1"
8.701-262.0	080320	Rubber Bumper – Replacement	

Pump Technical Information

Correct pump installation is essential for optimum performance. It is recommended that the pump flow capacity be oversized for the actual flow required. For optimum running of the system, the water circulated through the regulating valve should not exceed 10-15% of the pump flow. Recirculating too much water can generate heat in the supply tank increasing the cavitation risk. Frequently Asked Questions:

- Question: How much should you reduce the pump RPM to achieve a lower flow capacity? Answer: $\text{Required RPM} = \text{Expected Capacity} \times \frac{\text{Max RPM Allowed}}{\text{Max Allowed Capacity}}$
- Question: What diameter of pulley must I use to achieve the correct pump RPM? Answer: $\frac{\text{External Diameter of the Engine}}{\text{Motor Pulley}} = \text{External Diameter of the Pump Pulley} \times \frac{\text{Pump RPM}}{\text{Engine / Motor RPM}}$
- Question: What if I cannot change the engine / motor pulley? Answer: $\text{External Diameter of the Pump Pulley} = \frac{\text{External Diameter Engine}}{\text{Motor Pulley}} \times \frac{\text{Engine / Motor RPM}}{\text{Pump RPM}}$
- Question: If the engine / motor is running at a lower RPM than the maximum pump RPM allowed, what will be the pump flow capacity? Answer: $\text{Attainable Maximum Capacity} = \text{Engine / Motor RPM} \times \frac{\text{max capacity indicated on the label}}{\text{max RPM indicated on the label}}$
- Question: What is the approximate power required to achieve the maximum performances allowed? Answer: $\text{Required Electric Motor HP} = \text{Electric Motor HP} \times \frac{\text{PSI} \times \text{GPM}}{1460}$
 $\text{Required Gas Engine HP} \times \frac{\text{PSI} \times \text{GPM}}{1460} \times 1.30 = \text{Gas Engine HP}$

Conditions to prevent pump cavitation: Minimum difference in height HZ (pos / neg) between pump and water level.

The minimum inlet pressure value of the pump is limited by the cavitation phenomenon. Cavitation is the forming of vapor bubbles when the local pressure is below the vapor pressure of the liquid. Bubbles flow together with the liquid and when they reach a higher pressure area, they collide, generating abnormal stresses that are extremely dangerous to the pump components. To avoid the risk of cavitation, it is necessary that the pump installation is correct.

UNLOADERS, INJECTORS, VALVES & GAUGES

Legacy Universal Unloader (UU1)



The Legacy Universal Unloader is unique in that it allows for height or width adjustments making it ideal for any pump.



- 6 GPM
- 3500 PSI
- 195°F
- Forged-brass body
- 1/2" NPT inlet
- 3/8" NPT outlet
- Stainless-steel seat and low-friction, wear-resistant plunger
- 16.1 oz weight
- Patent US 8,313,311 B2

Part No	Description
9.175-018.0	Legacy Universal Unloader (UU1)

PLEASE NOTE: Legacy Universal Unloader (UU1) will not fit Legacy Pump GF 3530F

Minimum Adjustment:

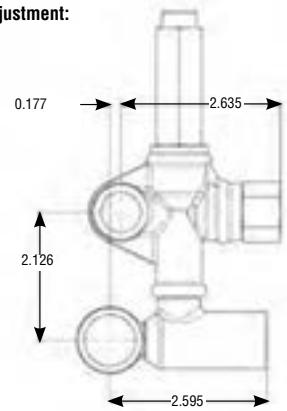

Maximum Adjustment:

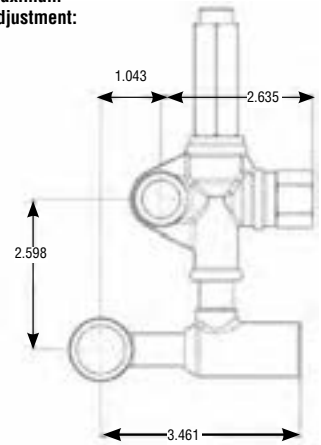

Adjusting inlet port

- 1.- Push up inlet port to make it shorter.
- 2.- Pull down inlet port to make it longer.



Adjusting horizontal sliding connector

- 1.- Turn the connector clockwise direction to make it shorter.
- 2.- Turn the connector counterclockwise direction to make it longer.

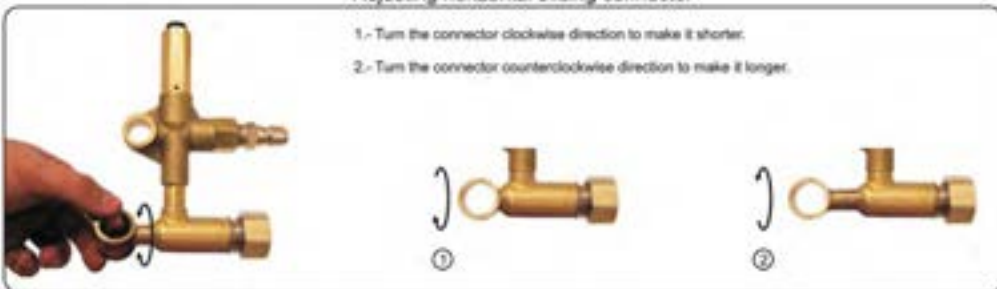

VBT Unloader

A trapped pressure direct mount unloader valve.

- 6.6 GPM
- 1500 - 4000 PSI
- 1/2" FPT inlet, 3/8" MPT outlet
- 195°F
- Brass, Stainless, Buna-N
- 1.95 lbs weight

Part No	Description	PSI	Fits Pump
8.754-696.0	Unloader, VBT Direct Mount	3000	LB, LP, LF
8.754-700.0	Unloader, VBT Direct Mount	4000	LB, LP, LF
8.754-701.0	Unloader, VBT Direct Mount	4000	LB, LP, LF
8.754-702.0	Unloader, VBT Direct Mount	4000	LM, LS
8.754-703.0	Unloader, VBT Direct Mount	1500	FOG



Automatic Pressure Regulator

Integral Regulator for Admiral Pumps: WE - WG - WEL - XLS - XLE - XLG bolt on for Admiral and Legacy Pumps. Trapped-pressure regulator specifically designed for use on the Admiral plunger pumps. Integral inlet, bypass and outlet eliminates the need for bypass hose.

- 6 GPM
- 3200 PSI
- 195°F
- Forged-brass body
- 3/8" MPT outlet
- Stainless-steel plunger and seat valve
- 29 oz weight



8.703-401.0

Part No	Old No	Description	Inlet
8.703-401.0	106020	APR-Brass / Black	3/8"
9.802-365.0	106022	APR-Brass / Black	1/2"
8.900-760.0	109139	Seal Repair Kit –	3/8"
8.900-761.0	109139X	Seal Repair Kit –	1/2"
8.900-762.0	109140	Valve Seat Repair Kit	

Regulators / Unloaders

Basic valves, premium performance.

- Forged-brass body
- Stainless-steel seat and piston
- 3/8" MPT inlet, outlet and bypass
- 194°F



520 Regulator / Unloader

- Rated @ 2000 PSI
- 13 oz weight
- Tested up to 2400 PSI
- 8 GPM

VR54 Black Regulator / Unloader

- Rated @ 2175 PSI
- 15 oz weight
- Tested up to 2800 PSI
- 8 GPM

VR54 Red Regulator / Unloader

- Rated @ 2900 PSI
- 13.7 oz weight
- Tested up to 2800 PSI
- 8 GPM

VR56 Regulator / Unloader

- Rated @ 3625 PSI
- 15 oz weight
- Tested up to 3400 PSI
- 8 GPM

Repair Kits

- For use with 520 regulator / unloaders

Part No	Old No	Description
8.712-589.0	462320K	520 w/ Knob
8.704-003.0	109177	Seal Repair Kit
8.704-004.0	109178	Valve Seat Repair Kit
8.753-028.0		VR54 Black
8.753-029.0		VR54 Red
8.753-017.0		VR56 w/ Knob

Regulator / Unloader VRS3



- 8 GPM
- 3630 PSI
- 194°F
- 3/8" MPT inlet and outlet, 1/4" FPT bypass
- Adjustable pressure setting nut
- Heavy-duty forged-brass body
- Stainless-steel ball and valve seat
- High-temperature Viton seals
- Adjustable upper-pressure limit lock



Part No	Description
8.753-027.0	w/o Knob
8.753-026.0	w/ Knob

VBA35 / VB55 Unloader Valves for Legacy HD Pumps

- 6.6 GPM
- 3500 PSI

Part No	Description
VBA35 for Legacy HD models	
9.803-899.0	GG, GD, GE
9.803-900.0	GM, GS

- 8 GPM
- 3650 PSI

Part No	Description
VB55 for Legacy HD models	
9.802-363.0	GM, GS



VRT3 Unloader Valves



- Forged-brass body
- Stainless internals
- Up to 4500 PSI
- 200°F
- 8 GPM
- 3/8" in-out / bypass

Part No	Description
8.750-297.0	2320 PSI Yellow
8.750-298.0	3630 PSI Blue
8.750-299.0	4500 PSI Black
8.750-300.0	4500 PSI w/ EZ Start Black
8.750-955.0	4500 PSI w/ Switch, w/o Knob
8.750-956.0	4500 PSI w/ Switch, w/ Knob
8.750-709.0	Repair Kit, VRT3, 2320/3630 PSI
8.750-710.0	Repair Kit, VRT3, 4500 PSI
9.802-694.0	Repair Kit Old Style VRT 605,606,607

VRT100 Unloader Valves



- Forged-brass body
- Stainless internals
- Up to 5075 PSI
- 194°F
- 26.4 GPM
- 1/2" in-out / bypass



Part No	Description
8.753-726.0	5075 PSI Blue
8.753-443.0	2760 PSI Yellow
8.753-444.0	5075 PSI Blue
8.753-727.0	5075 PSI Blue Microswitch 120/240VAC
8.754-012.0	VRT100 Repair Kit

Pulsar Unloaders

- Pulsar 4 blue rated 3200 PSI – Max 3650 PSI
- Pulsar 4 white rated 1400 PSI – Max 1750 PSI
- Pulsar 280 HP rated 4050 PSI – Max 4350 PSI
- 195°F
- 8 GPM
- All stainless-steel valves
- Pressure actuated
- Forged body
- 3/8" FPT inlet, outlet
- Two 3/8" FPT bypass ports



Part No	Original No.	Description
8.712-653.0	462654	Pulsar 4 (White) w/ Knob
8.704-462.0	111100	Repair Kit – Pulsar 4
9.802-004.0	111375	Repair Kit – 280 HP
8.754-866.0		Pulsar 4 RV / no knob
8.752-788.0		Pulsar 4 Blue Spring w/knob & switch

VB7 Regulator / Unloader

Fits CAT 4SF pumps and other pumps; 7.8 GPM – 3600 PSI max pressure.

- Rated pressure: 3200 PSI
- 200°F
- 3/8" MPT inlet, 1/4" FPT gauge port
- 3/8" FPT outlet and bypass
- 19.7 oz weight



Part No	Old No	Description
8.712-741.0	463670	w/o Knob
8.904-580.0	463670K	w/ Knob
8.704-488.0	111175	Repair Kit
8.712-735.0	463600	Knob Only

VB130 Regulator / Unloader

Fits CAT 2SF pumps and other pumps; 6.6 GPM – 2600 PSI max pressure.

- Rated pressure: 2300 PSI
- 200°F
- 3/8" MPT inlet and outlet
- 3/8" FPT bypass
- Stainless-steel plunger
- Stainless-steel valve seat
- 14.7 oz weight



Part No	Old No	Description
8.712-739.0	463660	w/o Knob
8.904-579.0	463660K	w/ Knob
9.802-006.0	111150	Repair Kit
8.712-735.0	463600	Knob Only

VB85 / 820 Regulator / Unloader

- VB85 rated @ 4050 PSI
- 200°F
- Pressure actuated
- Forged-brass body
- Stainless-steel plunger and seat
- 1/2" FPT in/out bypass
- 45 oz weight



Part No	Description
8.751-964.0	VB85/280 – Blue Spr
8.751-963.0	VB85/280 – Blue Spr

VB200 / 150 High-Volume Unloader

- 52.5 GPM
- Forged-bronze body
- Large plastic knob (removable)
- Lock nut on pressure adjustment
- 2175 PSI
- 194°F
- 1" FPT Inlet, outlet and bypass
- Two 5/16" – 18 bolt mounting ports
- 73.5 oz weight



Part No	Old No	Description
8.712-754.0	463714	VB 200/150 w/o Knob
8.712-755.0	463715	VB 200/150 w/ Knob
8.704-583.0	111550	Repair Kit

VB75 / VB135

The VB75 is an integrated unloader for Interpump and General pumps with 7.8 GPM – 3600 PSI max pressure. The VB135 fits Interpump “WW” Series Pumps and General “TT” Series Pumps with 6.5 GPM – 2600 PSI max pressure.

VB75

- Rated pressure: 3200 PSI
- 200°F
- 1/2" MPT inlet, 1/4" FPT gauge port
- 3/8" FPT outlet and bypass
- 19.7 oz weight



VB75

VB135

- Rated pressure: 2300 PSI
- 200°F
- 3/8" MPT inlet, 1/4" FPT outlet
- Stainless internals
- Forged-brass body
- 22.9 oz weight



VB135

Part No	Old No	Description
VB75		
8.712-742.0	463672/462646	Series 44 (EZ) and 47 pumps (W151)
8.704-488.0	111175	Seal Kit
8.712-735.0	463600	Knob Only
8.705-934.0		1/2" Bolt w/ Hole
VB135		
8.712-659.0	462659	VB 135
8.712-735.0	463600	Knob Only
9.802-006.0	111150	VB 135 Repair Kit
8.705-935.0		3/8" Bolt w/ Hole

VB80 / 400 Stainless-Steel Unloader

- 21 GPM
- Rated 5800 PSI
- Forged stainless-steel body
- 195°F
- All stainless-steel valve parts
- Viton seals
- 1/2" FPT inlet, outlet and bypass



Part No	Old No	Description
8.712-656.0	462656	VB 80/400
9.802-007.0	111340	Repair Kit

Trapped Pressure Unloader Valves VB10 / VB9

- 7.8 GPM – 3600 PSI
- Rated 3200 PSI
- 194°F
- Instant pressure response
- Hex-shaped non-stick check valve
- 3/8" in/out bypass
- Brass valve body/stainless ball and seat
- Knob included
- VB9 – Panel mountable
- Reduces trapped pressure to 25% of operating pressure when unloading; allows easier gun trigger pull



Part No	Old No	Description
8.712-736.0	463650	VB9 w/ Knob
8.715-462.0		VB9 w/ Knob and Pressure Switch
8.715-489.0		VB9 w/ Check Valve and Pressure Switch
8.712-745.0	463675	VB10 w/ Knob
8.704-548.0	111336	Repair Kit VB9
8.704-561.0	111400	Repair Kit VB10
8.901-056.0	111401	Seal Kit VB10

VB350 / 4 Unloader

Bigger. Stronger. Faster – 5600 PSI

- 10.5 GPM
- Rated 5100 PSI
- Max 5600 PSI
- 195°F max
- Forged-bronze body
- 31 oz weight
- Stainless-steel plunger and valve seat
- 3/8" FPT outlet and bypass
- 1/2" F bypass
- 3/8" MPT inlet, 1/4" gauge port



Part No	Old No	Description
9.802-360.0	463680K	Unloader Red Knob
8.704-499.0	111200X	Repair Kit Old VB 350
9.800-106.0	111901	Repair Kit – Red Knob Version

UNLOADERS, INJECTORS, VALVES & GUAGES

Control Set "W" Series / Integrated Regulator/Unloader



Designed exclusively to fit Interpump and General pumps.

- Mounts directly on pump inlet and outlet; internal bypass loop
- Pressure actuated: "Instant-On"
- 3/8" MPT outlets
- Integrated injector — Optional
- Pressure- and flow-engineered for specific pump models



Part No	Old No	Model	GPM	Fits PSI	Pump
"W" Series Unloaders					
8.712-638.0	462636	W1	4.00	1600	W905
8.712-640.0	462639	W1-L	4.00	1600	W99
8.712-643.0	462643	W2	5.56	3000	W997
8.712-644.0	462644	W2-L	5.56	3000	W201
8.702-883.0	103093B	W2/W2L Rebuild Kit			
8.702-888.0	103098B	W1/W1L Rebuild Kit			
"W" Series Unloaders with Injectors					
8.712-637.0	462635	W1-0	2.1-2.9	1600	W907
8.712-641.0	462640	W1L-1	3.0-4.0	1600	W99
8.712-642.0	462642	W2-1	2.9-4.0	3000	W997
8.712-645.0	462645	W2L-1	2.9-4.0	3000	W201
8.712-647.0	462647	W2L-2	4.2-5.5	3000	WS202
8.702-884.0	103094B	Injector Maintenance Kit			

"K" Series Pressure Regulators Kits



Repair Kits for All K3, K5, K7 and K9 models.

Part No	Old No	Description
8.702-850.0	103061B	K3 Rebuild Kit
8.702-847.0	103058B	K5 Maintenance Kit
8.702-849.0	103060B	K5 Rebuild Kit
8.705-045.0	140070	K5 Back Nut 3/4" NPT
8.702-858.0	103070B	K7 Repair Kit
8.702-911.0	103121B	K9 Repair Kit

"K" Series Pressure Regulators



Unloaders relieve line pressure in bypass mode.

- 3/8" FPT Inlet
- 165°F
- 1/2" FPT B

Part No	Old No	Model	GPM	Outlet
K3				
8.712-603.0	462530A	K3.0	2.10-2.90	3/8" M
8.712-605.0	462531A	K3.1	2.90-4.22	3/8" M
8.712-607.0	462532A	K3.2	4.22-5.55	3/8" M
8.712-609.0	462533A	K3.3	5.00-6.50	3/8" M
8.712-604.0		K3.0	2.10-2.90	1/2" M
8.712-606.0		K3.1	2.90-4.22	1/2" M
8.712-608.0		K3.2	4.22-5.55	1/2" M
8.712-610.0		K3.3	5.00-6.50	1/2" M
K5				
8.712-611.0	462551A	K5.1	2.90-4.22	3/8" M
8.712-613.0	462552A	K5.2	4.22-6.60	3/8" M
8.712-615.0	462553A	K5.3	6.60-10.83	3/8" M
8.712-612.0		K5.1	2.90-4.22	1/2" M
8.712-614.0		K5.2	4.22-6.60	1/2" M
8.712-616.0		K5.3	6.60-10.83	1/2" M

NOTE: 1) Use 8.705-045.0 back nut on bypass nipple when mounting 1/2" bypass line on K3s and K5s. 2) Use-restricted (.156 - .225 ID) orifice in bypass line for smoother operation/pressure balancing.

Part No	Description
8.715-478.0	Bypass plate for K3/K5
8.701-386.0	K7 - #0 Bypass Orifice 2.2 mm
8.701-389.0	K7 - #1 Bypass Orifice 2.5 mm



- 3/8" FPT
- 165°F

Part No	Old No	Model	GPM	Outlet
8.712-617.0	462570	K7.0	2.11-2.90	3/8" M
8.712-618.0	462571	K7.1	2.90-4.22	3/8" M
8.712-619.0	462572	K7.2	4.22-6.60	3/8" M
8.712-620.0	462573	K7.3	6.60-10.8	3/8" M

- 2.3-10.8 GPM
- 3/8" inlet BSP-F
- 165°F

Part No	Old No	Model	Outlet / Bypass
8.712-602.0	462526	2K138	3/8" BSP-M
8.712-601.0	462525	ZK1	1/2" BSP-M

- 1/2" FPT
- 165°F

Part No	Old No	Model	GPM	Outlet
8.712-621.0	462574	K9	13.2	1/2" M

Regulator/Unloader - HM



- Excess flow is bypassed to maintain selected pre:
- Will operate on single or multiple gun systems
- Brass body — stainless-steel valve and seat
- 3/8" FPT inlet
- 3/8" MPT outlet
- 3/8" FPT bypass
- Flow range – 1.4 to 10.8 GPM
- Pressure adjustable 0-3000 PSI



Part No	Old No	Description
8.712-622.0	462575	HM Regulator/Unloader
8.702-860.0	103072B	Repair Kit

Unloader - Hypro-Style

- All rated at 5 GPM
- Pressures from 400 to 1500 PSI
- 180°F
- Buna seals
- 3/8" MPT inlet and outlet
- 8 oz weight



Part No	Old No	Pressure	Bypass
8.712-689.0	462739	200-500	1/4" FPT
8.712-690.0	462740	400-1000	1/4" FPT
8.712-691.0	462743	800-1500	1/4" FPT
8.712-692.0	462745*	400-1000	
8.712-693.0	462748*	800-1500	
8.722-643.0	H34300223	Repair Kit for All	

*Bypass port not threaded, closed coupled

Unloader - YU – High-Volume

- 21 GPM
- 1/2" FPT inlet, outlet
- 2-1/2" FPT bypass ports
- 200°F
- Forged-brass body
- Stainless-steel internals

YU-2121 Yellow Spring YU-2140 Green Spring

- 2300 PSI
- 2600 PSI rated pressure
- 4050 PSI
- 4500 PSI rated pressure



Part No	Spring
8.753-326.0	Yellow
8.753-168.0	Green

Regulator / Relief Valve - ST-230



- 8 GPM
- Complete pressure regulation 0-3600 PSI
- 200°F
- 1/4" FPT inlet and bypass
- Mounts off-line — no line restrictions
- All brass body with stainless-steel piston and seat
- 14 oz weight



Part No	Old No	Description
8.712-628.0	462590	ST-230
8.701-626.0	087926	Repair Kit

Regulator / Unloader - ST-261



- 8 GPM
- Stainless-steel plunger and seat
- 0-3600 PSI regulation
- Viton seals
- 180°F temperature rating
- Forged-brass body
- 22.5 oz weight



ST-261 Standard

Part No	Old No	Description
8.712-681.0	462690	ST-261 STD
8.900-156.0	088211X	Seal Kit
8.701-627.0	088209	Repair Kit "B"
8.701-650.0	088466	Outlet Check Kit "A"

ST-261/S Unloader with Bypass Switch

- Switches at full bypass flow
- 10 Amp, 110/230V
- Wired N/C (may be wired N/O)



Part No	Old No	Model
8.712-685.0	462695	ST-261/S
8.701-647.0	088422	Switch Seal Kit

ST-261/I Unloader with Chemical Injector



Part No	Old No	GPM	Model
8.712-682.0	462691	0.0–2.4	ST-261/I-1
8.712-683.0	462692	2.4–3.5	ST-261/I-2
8.712-684.0	462693	3.5–5.5	ST-261/I-3
8.900-159.0	088260X	Injector Repr w/o Barb	
8.701-648.0	088424	Injector Repr w/ Barb	

ST-261/SI Unloader with Switch and Injector

- Switches at full bypass flow
- 10 Amp, 110/230V
- Wired N/C (may be wired N/O)



Part No	Old No	GPM	Model
8.712-686.0	462696	0.0–2.4	ST-261/SI-1
8.904-576.0	462697	2.4–3.5	ST-261/SI-2
8.904-577.0	462698	3.5–5.5	ST-261/SI-3

ST-261 Bypass Switch only

- Field-mountable
- 10 Amp @ 115/230V
- Switches at full bypass flow
- Wired N/C (may be wired N/O)



Part No	Old No	Description
8.712-629.0	462626	Switch Assy Complete
8.701-642.0	088272	Micro Switch Only
8.701-647.0	088422	Seal Kit – Micro Switch

UNLOADERS, INJECTORS, VALVES & GUAGES

Regulator / Unloader - ST-280

- 8 GPM
- 3600 PSI
- 175°F
- 27.5 oz weight
- Brass housing — stainless-steel valve
- 3/8" FPT inlet/outlet
- 1/4" FPT bypass



Part No	Old No	Description
8.712-674.0	462680	ST-280
8.701-655.0	088536	Seat Repair Kit "D"
8.701-654.0	088535	Piston Seal Kit "C"
8.701-653.0	088534	Poppet Repair Kit

Unloaders - AR Bolt-On

Mini-Matic Models.

- Fits XT and XM series pumps
- 2600 PSI-rated pressure
- 1-2" F inlet
- 3/8" M outlet



Part No	Old No	AR Model No.	GPM	Bypass
8.712-582.0		AR20608	3-5.5	AL, No injector
8.712-564.0	462228	AR20821	2-5	AL, No injector
8.712-573.0	462243	AR20890	2-3	AL, Adj injector
8.712-576.0	462246	AR21039	2-3	Brass, Adj injector
8.712-575.0	462245	AR21040	3-4	Brass, Adj injector
8.720-676.0	AR002812			Seal Kit

NOTE: AR has discontinued the Combiset unloaders. Use Mini-Matic unloaders as replacements. For 22mm twist coupler outlet models, add Part No. 8.709-546.0 (3/8" x 22mm) to injector outlet.

Unloaders - Gymatic

- RK and XM series pumps
- 3650 PSI-rated pressure
- 3-5.5 GPM
- 3/8" M outlet



Part No	Old No	AR Model No.	Inlet
8.712-565.0	462229	AR20242	1/2" F w/ no injector
8.712-563.0	462226	AR20242G	3/4" (GHF) w/ no injector
8.712-574.0	462244	AR20081	1/2" M fixed injector #1 (2-3 gal)
8.712-567.0	462233	AR20082	1/2" M fixed injector #2
8.712-568.0	462235	AR20399	1/2" M adj injector #1 (2-3 gal)
8.712-569.0	462236	AR20400	1/2" M adj injector #2
8.720-642.0	AR002611		Repair Kit

- Max PSI: 4000
- Max GPM: 5
- Inlet: 1/2" M
- Outlet: 3/8" M NPT
- Bypass: brass
- Without injector

Part No	Old No	AR Model No.
8.712-583.0	462255	AR21669

- Max PSI: 4000
- Max GPM: 5
- Inlet: 1/2" F
- Outlet: 3/8" M
- Bypass: brass

Part No	Old No	AR Model No.
8.720-903.0	AR20992	AR20992G

Unloaders - Pressure-Actuated 13 GPM



- 13 GPM
- 800-3000 PSI
- 160°F
- Bellville spring washers minimize spikes
- Forged-brass bodies / stainless ball and seat
- Four 1/4" side ports enhance versatility
- 1/2" FPT inlet, outlet and bypass ports
- 57.3 oz weight



Part No	Old No	Model No.	PSI	Spring
8.712-709.0	462934	22910	800	Silver
8.712-710.0	462935	22911	1400	Yellow
8.712-711.0	462937	22912	2400	Red
8.712-708.0	462933	22913	3000	Orange
8.722-137.0	G012099			Repair Kit

Unloaders - Pressure-Actuated



- Unloads pressure in entire system when in bypass
- Forged-bronze body
- Stainless-steel seat
- 3/8" FPT inlet/ 3/8" FPT outlet
- 1/4" FPT bypass
- 160°F



8.712-705.0 8.712-706.0

Part No	Old No	Model No.	GPM	PSI
8.712-705.0	462927	22760APM	8	3000
8.712-706.0	462928	22765APM	5	4000

Unloaders - Flow-Actuated



- Unloads pressure in entire system when in bypass
- Forged-bronze body
- Stainless-steel seat
- 3/8" FPT inlet/ 3/8" MPT outlet
- 1/2" bypass
- 160°F



Part No	Old No	Model No.	GPM	PSI
8.712-698.0	462909	22650	3.0-4.5	0-3000
8.712-701.0	462913	22654	3.5-4.8	3000-4000
8.712-702.0	462914	22655	4.5-5.5	0-3000
8.712-703.0	462915	22656	4.5-6.5	0-3000
8.722-204.0	G022666			Seal Kit

Unloaders - MG4000 Series

"The world's best unloader valve" with a choice of PSI: 1500, 3000 or 4500.

- Forged-brass body
- 3/8" FPT inlet, outlet and bypass
- Auxiliary 1/4" outlet
- 10 GPM
- 200°F
- Up to 4500 PSI
- Can be panel mounted
- Pressure limit indicated with color coded ring



Part No	Old No	PSI	Color
Without Knob			
8.712-715.0	463108	1500	Yellow
8.712-718.0	463110	3000	Red
8.712-724.0	463114	4500	Black
With Knob			
8.712-716.0	463108K	1500	Yellow
8.712-719.0	463110K	3000	Red
8.712-725.0	463114K	4500	Black
8.704-567.0	111442	Repair Kit	

MG4000 with Microswitch

- Can be used as Normally Open (NO) or Normally Closed (NC)
- Use for time-delay shutdown or as burner control
- Up to 4500 PSI
- Panel mountable
- 15 Amp microswitch



Part No	Old No	PSI	Color
8.712-717.0	463109K	1500	Yellow
8.712-720.0	463111K	3000	Red
8.712-714.0	463105K	3600	Blue
8.712-727.0	463115K	4500	Black

Safety Pressure Relief Valves



Engineered and built by Interpump.
Premium-quality valves for all pressure systems.

- Adjustable pop-off protection
- Machined-brass bodies
- Stainless-steel plunger and seat
- 165°F
- 3/8" MPT connect x 1/4" MPT
- Bypass and outlet
- S - R: Safety valve - 3000 PSI @ 1.3 to 10.8 GPM
- S - 3: Safety valve - 500 to 10,000 PSI @ 2.6 to 26.5 GPM



Part No	Old No	Description
8.711-215.0	390103	S - R Valve
8.711-227.0	390123	S - 3 Valve

Regulator Valve - Timax Pressure



- Max flow 52 GPM
- Max pressure 1000 PSI
- Lever control manual dump for bypass to relieve line pressure
- 3/4" and 1" FPT inlet and outlet
- 3/4" FPT bypass
- Brass body - stainless-steel piston and seat



Part No	Old No	Description
8.712-624.0	462580	Timax Reg Valve
8.702-844.0	103051B	Repair Kit

Regulator - VS 200 / 180 High-Volume



- 53.5 GPM
- 2600 PSI
- 194°F
- 3/4" FPT inlet x 1/2" FPT bypass
- 29.4 oz weight



Part No	Old No	Description
8.712-753.0	463705	VS 200/180
8.704-582.0	111520	Repair Kit

Regulator / Relief Valve - VS 350



- Rated pressure: 5100 PSI
- 5600 PSI
- 6.5 GPM
- 195°F
- 3/8" FPT inlet, outlet and bypass
- 16.8 oz weight



Part No	Old No	Description
8.712-756.0	463720	VS 350
8.704-611.0	111832	Repair Kit

Regulator / Relief Valve VS 500 High-Pressure



- Forged-bronze body
- 21 GPM
- 7250 PSI-rated pressure
- 8100 PSI maximum pressure
- 195°F
- 1/2" FPT inlet and 3/8" FPT bypass
- 14.2 oz weight



Part No	Old No	Description
8.712-757.0	463725	VS 500

UNLOADERS, INJECTORS, VALVES & GUAGES

Regulator / Relief Valve - VS 220

6.3 GPM – 3600 PSI max pressure

- Rated 3200 PSI
- 200°F
- Forged-bronze body
- Stainless-steel plunger and seat valve
- Two 3/8" FPT inlets
- 3/8" FPT outlet/bypass
- Compact design
- 14.2 oz weight



Part No	Old No	Description
8.712-737.0	463655	VS 220 w/o Knob
8.901-057.0	111576	Repair Kit

Regulating Relief Valve

Economical replacement for paraplate BR5 Series.

- 7 GPM
 - Pressure adjusts 200-2000 PSI
 - 200°F
 - 3/8" FPT inlet, outlet and bypass
 - Flow-thru design
- for smooth operation
- Machined-brass body and knob
 - Stainless-steel plunger and seal



Part No	Old No	Description
8.712-625.0	462585	Relief Valve
8.900-042.0	075127	Repair Kit

Unloader Mounting Block

End vibration-caused fitting failure.

- 12 GPM
- Mounting hardware included
- Machine block brass or steel



Part No	Old No	Description	Material	PSI
8.904-568.0	462183X	3/8" x 3/8"	Brass	5500
8.904-567.0	462182X	1/2" x 1/2"	Brass	5500
9.802-870.0		3/8" x 3/8"	Steel	
9.802-871.0		1/2" x 1/2"	Steel	

Chem Injector - 5500 PSI Stainless Steel



Part No.	Old No	GPM	PSI	Description
9.802-217.0	3-1208	3.0-5.0	5500	Non-Adjustable, Injector Only
9.802-226.0	4-011186	3.0-5.0	5500	Assembly

Injector - Amerimax

The higher rate injector. Our best seller!

- Brass housing
- Stainless-steel orifice
- Fully adjustable metering valve
- Stainless-steel spring
- 3500 PSI
- 3/8" MPT inlet/outlet
- 1/4" hose barb



Part No	Old No	Description
Standard		
8.904-192.0	360130	"0", 1-2 GPM
8.904-193.0	360131	"1", 2-3 GPM
9.803-998.0	360132	"2", 3-5 GPM
8.904-194.0	360133	"3", 5-8 GPM
8.900-040.0	075122X	Repair Kit (Stainless-Steel Check Ball)
"Acid" Injector w/ Special Inlet Check Valve		
8.904-201.0	360140X	"0A", 1-2 GPM
8.904-202.0	360141X	"1A", 2-3 GPM
8.904-203.0	360142X	"2A", 3-5 GPM
8.904-204.0	360143X	"3A", 5-8 GPM
8.700-536.0		Ceramic Ball for 8.904-203.0
8.900-041.0	075123X	Acid Repair Kit*

*Ceramic check ball

Quick-Coupled Amerimax

Assembled for added convenience — quick couples to unloader outlet and quick couples hose to injector outlet.

- Top-quality quick couplers: 3/8" plug inlet, 3/8" socket outlet
- 6' industrial-grade poly-braid reinforced tubing (will not collapse, resists crimping, high-chemical tolerance)
- Heavy-duty brass chemical filter with check valve prevents loss of prime



Part No	Old No	Description
Amerimax "QC"		
8.904-195.0	360135X	Quick-Coupled "0", 1-2 GPM
8.904-196.0	360136X	Quick-Coupled "1", 2-3 GPM
8.904-197.0	360137X	Quick-Coupled "2", 3-5 GPM
8.904-199.0	360138X	Quick-Coupled "3", 5-8 GPM
8.900-040.0	075122X	Repair Kit (Stainless-Steel Check Ball)
Amerimax Acid "QC"		
8.904-205.0	360145X	Quick-Coupled "0A", 1-2 GPM
8.904-206.0	360146X	Quick-Coupled "1A", 2-3 GPM
8.904-207.0	360147X	Quick-Coupled "2A", 3-5 GPM
8.904-208.0	360148X	Quick-Coupled "3A", 5-8 GPM
8.900-041.0	075123X	Acid Repair Kit*

*Ceramic check ball

Chemical Injector - ST-60



Requires ST-61(below) to regulate chemical injection rate.

- Forged-brass body
- Compact size
- Forged-brass body
- Inlet 3/8" MPT
- Outlet 3/8" FPT



Part No	Old No	Description
8.710-476.0	360120	1.50-2.25, ST-60/0
8.710-477.0	360121	2.25-3.35, ST-60/1
8.710-478.0	360122	3.35-5.00, ST-60/2
8.701-648.0	088424	Repair Kit "F"

Chemical Metering Valve - ST-61



- Snap-on attachment to ST-60, ST-62, ST-261/1 usage limited to these injectors
- Adjusts from off to full flow
- Glass-filled polyamide body and valve parts
- 1/4" hose barb
- Teflon® seals



Part No	Old No	Description
8.710-777.0	371161	ST-61

Chemical Injector - ST-62 Variable



Flow orifice adjusts for machines from 2-8 GPM. Requires ST-61 to regulate chemical injection rate.

- Forged-brass body
- 3500 PSI
- 8 GPM



Part No	Old No	Description
8.710-485.0	360162	ST-62
8.701-648.0	088424	Repair Kit "F"

Injector - ST-64 Up Stream



Apply soap at high pressure. Restricts waterflow to create suction.

- 140 PSI
- 160°F
- 3/4" FGH inlet
- 3/4" MGH outlet
- Chemical strainer and 4' PVC tubing included
- Adjustable with ST-61 meter valve
- Locking waterflow adjustment



Part No	Old No	GPM
8.710-482.0	360155	1.5-4.0
8.710-483.0	360156	4.0-7.0

Chemical Injectors - Robokim



- Forged-brass body
- Stainless-steel orifice
- Stainless-steel inlet check valve components
- 3500 PSI
- 180°F
- 3/8" MPT inlet/outlet
- 1/4" hose barb



Part No	Old No	Description
Robokim w/ Plastic Meter Knob		
8.710-497.0	360200	"0", 2.1-2.9 GPM
8.710-498.0	360201	"1", 3.0-4.0 GPM
8.710-499.0	360202	"2", 4.0-5.5 GPM
8.710-500.0	360203	"3", 5.5-10.8 GPM
Robokim w/ Brass Meter Knob		
8.904-213.0	360220	"0", 2.1-2.9 GPM
8.904-214.0	360221	"1", 3.0-4.0 GPM
8.904-215.0	360222	"2", 4.0-5.5 GPM
8.904-216.0	360223	"3", 5.5-10.8 GPM
8.900-481.0	103053X	Repair Kit
8.900-061.0	077010X	Acid Kit

Chemical Injectors - Robokim Quick-Coupled

- Quick-couplers: 3/8" QC plug inlet, 3/8" QC socket outlet
- 6' industrial-grade poly-braid reinforced tubing
- AP brass chemical filter w/ stainless-steel check valve



Part No	Old No	Description
Robokim "QC" w/ Plastic Knob		
8.904-209.0	360210X	"0", 2.1-2.9 GPM
8.904-210.0	360211X	"1", 3.0-4.0 GPM
8.904-211.0	360212X	"2", 4.0-5.5 GPM
8.904-212.0	360213X	"3", 5.5-10.8 GPM
Robokim "QC" w/ Brass Knob		
8.904-217.0	360230X	"0", 2.1-2.9 GPM
8.904-218.0	360231X	"1", 3.0-4.0 GPM
8.904-219.0	360232X	"2", 4.0-5.5 GPM
8.904-220.0	360233X	"3", 5.5-10.8 GPM

Hi-Lo Injector



May be used on high or low side of pump. Adjustable flow orifices plus adjustable chemical valves. Standard features similar to ST-62.

- Performance Range: Low side: .5-3.5 GPM @ 10-120 PSI
- High side: 2.0-8.0 GPM @ 3500 PSI
- Machined-brass body
- 3/8" FPT inlet/outlet



Part No	Old No	Description
8.710-486.0	360163	Hi/Lo Injector w/ Meter Valve
8.710-487.0	360165	w/o Chemical Adjust
8.700-290.0	075136	Repair Kit
8.900-044.0	075136X	Seal Kit

Chemical Injectors - 400 Series



The injector of choice

- Teflon® valve seat
- 3/8" inlet and outlet (3 configurations)
- Forged-brass housing
- 3200 PSI
- Renewable orifices and check valve
- 200°F
- Options include: quick-coupled, stainless-steel orifices/ acid-resistant check
- Only 5 oz weight



Orifice Selection

Orifice Dia.	Flow Rate
1.6mm	1.5-2.7 GPM
1.8mm	2.0-3.6 GPM
2.1mm	2.7-4.9 GPM
2.3mm	3.3-6.0 GPM

Adjustable Injectors, precise needle-metering valve.

Orifice Size(mm)	M x M Part No	M x M Old No	M x F Part No	M x F Old No	F x M Part No	F x M Old No
Brass						
1.6	8.710-541.0	360406	8.710-549.0	360416	8.710-559.0	360426
1.8	8.710-535.0	360400	8.710-543.0	360410	8.710-551.0	360420
2.1	8.710-537.0	360401	8.710-545.0	360411	8.710-554.0	360421
2.3	8.710-539.0	360402	8.710-547.0	360412	8.710-557.0	360422
Stainless-steel						
1.6	8.710-542.0	360406S	8.710-550.0	360416S	8.710-560.0	360426S
1.8	8.710-536.0	360400S	8.710-544.0	360410S	8.710-552.0	360420S
2.1	8.710-538.0	360401S	8.710-546.0	360411S	8.710-556.0	360421S
2.3	8.710-540.0	360402S	8.710-548.0	360412S	8.710-558.0	360422S

Part No	Old No	Description
Repair Kits include Check Ball, Spring, Seat and O-ring		
8.900-769.0	109220X	Standard Kit

Orifice Size(mm)	M x M Part No	M x M Old No	M x F Part No	M x F Old No	F x M Part No	F x M Old No
Brass/Acid-Resistant						
1.6	8.904-230.0	360406A	8.904-238.0	360416A	-	-
1.8	8.904-224.0	360400A	8.904-232.0	360410A	8.904-240.0	360420A
2.1	8.904-226.0	360401A	8.904-234.0	360411A	8.904-242.0	360421A
2.3	8.904-228.0	360402A	8.904-236.0	360412A	8.904-244.0	360422A
Stainless-steel/Acid-Resistant						
1.6	8.904-231.0	360406AS	8.904-239.0	360416AS	8.904-246.0	360426AS
1.8	8.904-225.0	360400AS	8.904-233.0	360410AS	8.904-241.0	360420AS
2.1	8.904-227.0	360401AS	8.904-235.0	360411AS	8.904-243.0	360421AS
2.3	8.904-229.0	360402AS	8.904-237.0	360412AS	8.904-245.0	360422AS

Part No	Old No	Description
Repair Kits include Check Ball, Spring, Seat and O-ring		
8.900-770.0	109222X	Acid Kit

Series 505 Stainless-Steel

All metal parts are stainless-steel

- Premier type injector
- 8 GPM
- 5650 PSI
- 3/8" inlet/outlet
- 195°F
- Teflon O-rings



Part No	Old No	Description	GPM
8.710-586.0	360505/1.8	Stainless-Steel Injector 1.8	2.0-3.6
8.710-587.0	360505/2.1	Stainless-Steel Injector 2.1	2.7-4.9
8.710-588.0	360505/2.3	Stainless-Steel Injector 2.3	3.3-6.0
8.704-027.0	109234	Repair Kit	

Injector - Adjustable Quick-Connect

- 3500 PSI
- 200°F



Part No	Original No.	GPM
8.710-502.0	360240	2-3
8.710-503.0	360242	3-5
8.710-504.0	360244	5-8
Acid Injectors		
8.904-221.0	360240A	2-3
8.904-222.0	360242A	3-5
8.904-223.0	360244A	5-8
8.701-187.0	080055	Injector Repair Kit
8.900-087.0	080056	Injector Acid Kit

Injectors - Brass

All metal parts are brass

- Premier type injector
- 3200 PSI
- 3/8" inlet/outlet
- 190°F



Part No	Old No	Description	GPM
8.710-505.0	360245	Brass Injector 1.8	2.0-3.6
8.710-506.0	360246	Brass Injector 2.1	2.7-4.9
8.710-507.0	360247	Brass Injector 2.3	3.3-6.0
8.704-028.0	109235	Repair Kit	

Pressure Reducer/Injector - Exact-A-Flow

"Low side" chemical injector that regulates inlet pressure to maintain consistent chemical ratio.

- Up to 6 GPM
- 1/2" FPT I/O ports
- 1/4" hose barb chemical inlet
- ± 2% injection ratio variation



Part No	Old No	Description
8.711-162.0	385127	Weep Seat*
8.711-160.0	385125	Non-Weep
8.711-161.0	385126	With Switch**
8.904-389.0	385128	Hose Barb w/ Viton Check
8.904-390.0	385129	Hose Barb w/ Buna Check

*Weep Seat allows pump to self-prime

**With burner control switch automatically turns burner off when water flow stops

UNLOADERS, INJECTORS, VALVES & GAUGES

Adjustable Bronze Float Valves



- Cast-bronze body
- Adjustable float arm
- Live rubber stopper
- 180°F



Part No	Old No	Thread	Stem	GPM @ 40 PSI
8.710-045.0	343306	1"	1/4" - 20	47

NOTE: Float valves above require stem and float, below

Repair Parts for Adjustable Valves

8.700-475.0	076406	Long Arm*
8.700-476.0	076407	Short Arm*
8.700-477.0	076408	Thumb Screw*
8.700-479.0	076418	3/8" and 1/2" Plunger
8.700-481.0	076422	1" Plunger

*Fits 3/8", 1/2" and 3/4" valve only

Stems Only



9.802-157.0

8.710-047.0

Part No	Old No	Length	Material	Thread
9.802-157.0	343310	8"	SS	1/4" - 20
8.710-047.0	343310C	8"	Brass	1/4" - 20 x 5/16" - 18
8.710-051.0	343315	10"	SS	1/4" - 20

Parts for other float valves also available

Copper and Plastic Float Balls



8.710-053.0



9.802-061.0

Part No	Old No	Length	Material	Thread
8.710-061.0	343326	4" x 5"	Copper	1/4" - 20
8.710-052.0	343317	5"	Copper	1/4" - 20
8.710-053.0	343318	6"	Copper	1/4" - 20
Plastic				
8.710-057.0	343321	6"	Plastic	1/4" - 20
8.710-059.0	343323	8"	Plastic	1/4" - 20
9.802-061.0	343325	4" x 5"	Plastic	1/4" - 20

Parts for other float valves also available

PA Float Valve



- 140°F
- 3/8" BSP inlet
- Brass body
- Positional/adjustable arm
- 5 GPM @ 15 PSI
- 7 GPM @ 30 PSI



Part No	Old No	Description
8.710-042.0	343301	3/8" Float Valve
8.704-204.0	110250	Repair Kit

Brass Float Valve Assembly



Complete assembly includes valve, stem and float.

- 1/2" FPT inlet
- Brass housing with polyamide cover
- 4.5 GPM
- 175°F



Part No	Old No	Description
8.710-031.0	343010	ST-8
MPT Adapter Kit for ST-8*		
8.710-033.0	343012	

*Double MPT nipple, sealing washer and lock nut

Brass Float, Ball and Stem



- 142 PSI max inlet pressure
- 140°F
- 7.1 GPM @ 28 PSI - 1/2" MPT inlet
- Positive soft Buna/brass shut-off
- Adjustable float ball settings
- Inlet nut and washer seal provided



Part No	Old No	Description
8.710-037.0	343050	Valve Complete
8.704-092.0	109502	Repair Kit

Diaphragm Float Valve

- Requires only 6.5" x 3" inside tank
- All-plastic snap-on float
- Positive shutoff diaphragm style
- Inlet screen, tank gasket and nut included
- Rebuildable — repair parts available
- 3/4" MPT inlet
- 142 PSI
- 7.86 GPM @ 28 PSI
- 6.68 GPM @ 14 PSI
- 140°F



Part No	Old No	Description
8.710-030.0	343007	Float Valve Complete

Vertical Float Tank Valve

- 9 GPM @ 150 PSI - 1/2" MPT inlet
- 140°F
- Inlet nut and washer seal provided



Part No	Description
9.802-185.0	Vertical Float Tank Valve

Hudson Float Valve

- No external moving parts
- No float ball or arm
- Operates between 0-130 PSI
- All plastic, nylon, rubber and stainless-steel
- 90°F
- 1" inlet — easy installation
- Automatic anti-siphon
- Flow capacity 80% of supply (40 GPM @ 40 PSI)



Part No	Old No	Description
8.710-035.0	343022	1" Hudson Float Valve, 90°
8.710-036.0	343026	1" Hudson Float Valve, 150°

Kerick Float Valve

- Flow rates for 1/2" valve:
 - 20 PSI: 7.7 GPM
 - 30 PSI: 9.1 GPM
 - 40 PSI: 10.5 GPM
 - 50 PSI: 11.4 GPM
 - 60 PSI: 12.5 GPM
- Flow rates for 3/4" valve:
 - 30 PSI: 13 GPM
 - 60 PSI: 16.5 GPM



Part No	Description
8.749-328.0	1/2" Float Valve, .25" orifice
8.749-329.0	3/4" Float Valve, .30" orifice

Check Valves – Swing Action

Retain prime on pumps with low-lift capability

- Brass body with swing (flapper) action
- 150 PSI
- FPT inlet/outlet
- Gravity seal — no spring pressure



Part No	Old No	Description
8.709-378.0	310862	1/2"
8.709-379.0	310863	3/4"
8.709-380.0	310864	1"
8.709-381.0	310865	1-1/4"
8.709-382.0	310866	1-1/2"
8.709-383.0	310868	2"

Stainless-Steel Check Valves

- Rated pressure: 5800 PSI
- 6500 PSI
- 195°F
- Female x female
- 2.0 oz weight



Part No	Old No	Description	Flow Rate
8.709-361.0	310827	1/4" F x F	6.1
8.709-362.0	310828	3/8" F x F	10.5

High-Pressure Check Valves

2500 or 3000 PSI ball check.

- Buna seals
- Stainless-steel check ball
- Machined-brass body
- 1 PSI cracking pressure



Part No	Old No	Description
2500 PSI Miniature Ball Check		
8.709-356.0	310814	1/4", M x F
8.709-357.0	310815	1/4", M x M
3000 PSI Stainless Guided Ball and Quad Ring Seat		
8.709-358.0	310820	1/4", F x F
8.709-359.0	310822	3/8", F x F

Check Valves – 1200 PSI

Allows excellent low-restriction flow in inlet direction and instant positive-check action in reverse direction.

- Machined-brass body
- Poppet seal
- Cracking pressure 1 PSI



Part No	Old No	Description
8.709-351.0	310804	1/4", F x F
8.709-352.0	310806	3/8", F x F
8.709-353.0	310808	1/2", F x F
8.709-354.0	310811	3/4", M x M

Brass Check Valves – Spring-Loaded

Holds pump prime without overloading pump suction

- Machine-cast brass bodies, FPT x FPT
- 150 PSI
- 250°F
- Mount horizontal or vertical



Part No	Old No	Description
8.709-384.0	310872	1/2"
8.709-385.0	310873	3/4"
8.709-386.0	310874	1"

UNLOADERS, INJECTORS, VALVES & GAUGES

Backflow Preventor – Check Valve

Protects water supply from harmful chemical backflow — will not allow “spike” pressure to push chemicals into supply line. Now required by many city and state regulations.

- 3/4" female garden hose inlet (with lock screw)
- 3/4" male garden hose outlet
- Machined-brass housing
- Plastic diaphragm check



Part No	Old No	Description
8.705-039.0	140060	Backflow Preventor

PVC Check Valve

Holds pump prime without overloading pump suction.

- Designed for harsh chemical applications
- PVC plastic body
- Stainless-steel ball check
- Cracking press 1 PSI
- Choice of connects
- 125 PSI
- 180°F



Part No	Old No	Description
8.709-366.0	310834	1/4" MPT x 1/4" Barb
8.709-367.0	310835	1/4" Barb x 1/4" MPT
8.709-369.0	310837	1/4" Barb x 1/4" Barb
8.709-370.0	310838	3/8" Barb x 3/8" Barb
8.709-373.0	310844*	1/2" Barb x 1/2" Barb

*8.709-373.0 has Viton seals

Stainless-Steel Ball Valves – 2000 PSI

- Full-flow ports
- Investment cast process
- Two-piece 316 stainless bodies
- Glass-filled Teflon® seals
- 180°F @ 2000 PSI
- 300°F @ 1000 PSI
- 350°F @ 300 PSI



Part No	Old No	Description
8.709-265.0	306534	1/4" F x F
8.709-266.0	306536	3/8" F x F
8.709-268.0	306538	1/2" F x F
8.709-269.0	306540	3/4" F x F

Forged-Brass Ball Valves

- 600 PSI
- 180°F
- Forged-brass body
- Full-flow ports
- Teflon PTFE seals



M x F Part No	F x F Part No	M x M Part No	Size
8.709-249.0	8.709-250.0	8.709-251.0	1/4"
8.709-252.0	8.709-253.0	8.709-254.0	3/8"
8.709-255.0	8.709-256.0	8.709-257.0	1/2"
8.709-258.0	8.709-259.0	8.709-260.0	3/4"
8.709-261.0	8.709-262.0	8.709-263.0	1"

Nickel-Plated Brass Ball Valves



- Threaded FPT connects
- Chrome-plated ball
- Seats and seals have glass-filled Teflon®
- Full-flow bore



Part No	Old No	Description	Working Pressure (PSI)
8.709-242.0	306504	1/4"	710
8.709-243.0	306506	3/8"	710
8.709-244.0	306508	1/2"	710
8.709-245.0	306512	3/4"	570
8.709-246.0	306516	1"	570
8.709-247.0	306520	1-1/4"	430
8.709-248.0	306524	1-1/2"	430
8.709-264.0	306532	2"	360

Mini Ball Valves

- Forged-brass body
- 600 PSI
- 180° handle movement



M x F Part No	F x F Part No	M x M Part No	Size
8.709-208.0	8.709-209.0	-	1/8"
8.709-211.0	8.709-212.0	8.709-213.0	1/4"
8.709-216.0	8.709-217.0	8.709-218.0	3/8"

High-Pressure Ball Valves

- Rugged carbon steel construction
- 2-way
- NPT (F x F) threads
- Blow-out proof stems
- Delrin ball seats
- Viton O-rings



Part No	Old No	FPT	PSI
8.709-274.0	306552	1/4" x 1/4"	7350
8.709-276.0	306553	3/8" x 3/8"	7350
8.709-279.0	306554	1/2" x 1/2"	7350
8.709-282.0	306556	3/4" x 3/4"	5880
8.700-270.0	075080	Replacement handle – fits all sizes above	
8.700-271.0	075089	Replacement screw for handle	

Stainless-Steel, High-Pressure Ball Valves – 5800 PSI

- 316 stainless-steel body, ball and stem
- Viton O-rings
- Delrin ball seats
- Full port



Part No	Old No	FPT	PSI
8.709-277.0	306553S	3/8" x 3/8"	5880
8.709-280.0	306554S	1/2" x 1/2"	5880
8.709-283.0	306556S	3/4" x 3/4"	5880
8.709-286.0	306558S	1" x 1"	5880

Ball Valves - Stainless-Steel, One-Piece – 800 PSI

- Standard port
- 316 stainless-steel body
- 300°F @ 800 PSI
- 350°F @ 400 PSI
- Suitable for steam



Part No	Old No	FPT
8.709-287.0	306582	1/4" x 1/4"
8.709-288.0	306583	3/8" x 3/8"
8.709-289.0	306584	1/2" x 1/2"
8.709-290.0	306585	3/4" x 3/4"

Ball Valves - Brass Mini

- Compact knob operation
- Brass housing-hex bar
- 220 PSI working pressure
- Designed to fit tight quarters
- Teflon® seals
- Only 1-3/4" long



Part No	Old No	FPT
8.709-270.0	306542	1/8" x 1/8"
8.709-271.0	306544	1/4" x 1/4"
8.709-272.0	306546	3/8" x 3/8"
8.709-273.0	306548	1/2" x 1/2"

Ball Valves - PVC

Great for chemical on/off flow control

- PVC and nitrile material
- Chemical and impact resistant
- Flag handle
- 180°F
- 125 PSI



Part No	Old No	Description
8.709-214.0	306352P	1/4" Panel Mtg, Barb x Barb
8.709-219.0	306354P	1/4" In-line, Barb x Barb
8.709-220.0	306356	3/8" In-line, Barb x Barb

Ball Valves - Compact PVC

- FPT thread both ends
- 150 PSI working pressure
- Easy-turn handle
- 150°F
- EPDM seals – white body



Part No	Old No	FPT
8.709-233.0	306444	1/4" x 1/4"
8.709-234.0	306448	1/2" x 1/2"
8.709-235.0	306450	3/4" x 3/4"
8.709-236.0	306452	1" x 1"
8.709-237.0	306454	1-1/4" x 1-1/4"
8.709-238.0	306456	1-1/2" x 1-1/2"
8.709-239.0	306460	2" x 2"

Ball Valve Brass

- 3000 PSI



Part No	Old No	Description
8.753-959.0		Ball Valve Brass, 3/8" F x F, BSPF x BBPP

Ball Valves - Polypropylene

Full port reinforced polypropylene.

- 150 PSI working pressure
- Easy turn w/ Teflon® seals
- Double seal in stem for "no leak"
- Threaded mounting bosses, brass insert on 1-1/4"- 2" sizes



Part No	Old No	FPT
Two-Way Ball Valves		
8.709-222.0	306390	1/2" x 1/2"
8.709-223.0	306392	3/4" x 3/4"
8.709-224.0	306394	1" x 1"
8.709-225.0	306398	1-1/2" x 1-1/2"
8.709-226.0	306400	2" x 2"

Part No	Old No	FPT
Three-Way Ball Valves		
8.709-227.0	306408	1/2" x 1/2" x 1/2"
8.709-228.0	306412	3/4" x 3/4" x 3/4"
8.709-229.0	306416	1" x 1" x 1"
8.709-230.0	306420	1-1/4" x 1-1/4" x 1-1/4"
8.709-231.0	306422	1-1/2" x 1-1/2" x 1-1/2"
8.709-232.0	306424	2" x 2" x 2"

Ball Valve - 3-Way

- 400 PSI maximum pressure
- 180°F maximum temperature
- Teflon seat
- Buna seals
- Brass



Part No	Old No	Description
8.709-207.0	306331	1/4" M x F x F

Flow Selector Valve

3-way and 4-way lever control with brass body.

- 3-way
- Plumb for 2 inlets and 1 outlet or 1 inlet and 2 outlets
- 4-way
- Plumb for 3 inlets and 1 outlet or 1 inlet and 3 outlets
- 180°F rated temperature



Part No	Old No	Description
8.710-108.0	343734	1/4" FPT 3-Way
8.710-110.0	343736	3/8" FPT 3-Way
8.710-113.0	343744	1/4" FPT 4-Way
8.710-114.0	343746	3/8" FPT 4-Way

UNLOADERS, INJECTORS, VALVES & GUAGES

Flow Control Metering Valve

- Forged-brass, nickel-plated body
- Panel mtg in 17/32" hole
- Compact size
- Double-stem seal
- 300 PSI
- 175°F rated temperature



Part No	Old No	Description
8.710-775.0	371125	1/4", FPT In/out
8.710-776.0	371133	3/8", FPT In/out

Flow Control Metering Valve

The valve that "seals" (will not suck air).

- 3500 PSI to 28" vacuum — no leak
- Viton gland seal isolates metering threads from solution
- Stainless-steel needle / brass seat
- 1/4" FPT ports
- Heavy-duty brass bar stock body
- 195°F rated temperature
- Panel mounts 5/8" hole
- Large easy-grip four-lobe handwheel
- Aluminum or poly available



Part No	Old No	Description
8.904-362.0	371120X	Metering Valve / Alum Knob
8.904-361.0	371120P	Metering Valve / Poly Knob
8.740-083.0	077003A	Replacement Knob

Brass Metering Valve

- 1/4 inlet/outlet
- 450 PSI
- 170°F
- Easy-grip, fluted plastic handle with pointer
- Brass body, Viton gland seal eliminates air leaks
- Panel mount 11/16" or 3/4" hole
- Extremely compact T-style



Part No	Old No	Description
8.710-773.0	371115	"T" 1/4" F x F — Forged
8.710-774.0	371116	"L" 1/4" M x M — Machined
9.802-188.0		"L" 1/4" M x M

Chemical Metering Valves

- Adjusts from off to full flow
- 4000 PSI
- 1/4" FPT inlet – outlet
- 6 GPM
- 9.802-187.0 has presettable limiting orifice



9.802-187.0

Part No	Old No	Description
8.710-771.0	727628	Flow Control
9.802-187.0	2-30151	Flow Control w/ Locking Adjustment
9.802-532.0		Valve, Less Solenoid

Chemical Metering / On-Off Valve

- Dual-knob control — calibrate chemical flow w/ base knob. Outside knob allows on/off control without changing calibration
- Single 1/2" hole panel mounting
- Brass and stainless-steel materials



Part No	Old No	Description
8.710-770.0	371100	MV-100

Chemical Meter and Selection Valve - ST-66



- Two input barbs — for different chemicals to single outlet barb
- Double-metering dial with center OFF
- Panel mount in single 5/8" hole



Part No	Old No	Description
8.710-779.0	371166	ST-66

Steam Valve

For "combo" hot pressure washer/steamer units. The single-turn on/off diverter valve bypasses pump flow to reduce water flow to the coil, creating steam in place of normal hot water.

- Panel mount in 11/16" or 3/4" hole
- Machined-brass body
- Easy-grip plastic knob
- 3600 PSI
- 175°F
- 1/4" MPT inlet/ outlet



Part No	Old No	Orifice (mm)
8.711-263.0	400008	0.8
8.904-406.0	400012	1.2
8.904-407.0	400015	1.5
8.904-408.0	400018	1.8
8.904-409.0	400020	2.0

Thermal Relief Valves



A MUST for any pump that might ever be left in bypass mode (unloading) for more than 15 seconds. Protects the pump from overheating caused by recirculating water.



- Installs in bypass line
- Automotive style wax element
- Automatically resets at cool down to 115°+ F
- No adjustment required
- 1/8" FPT side discharge
- 125 PSI inlet pressure
- 2.5 GPM flow

Part No	Old No	Inlet	"Trip" Temp
8.904-564.0	458000	1/4" MPT	140°F
8.904-565.0	458001	3/8" MPT	140°F
8.904-566.0	458005	1/2" MPT	140°F
8.723-943.0	458007	1/2" MPT	165°F

Compact Thermal Relief Valves

- 145°F or 190°F "Trip" temperature



Part No	Old No	Size	"Trip" Temp
8.712-544.0	458024	1/4" MPT	145°F
8.712-545.0	458026	3/8" MPT	145°F
9.802-181.0	921421	3/8" MPT	145°F
9.804-025.0		1/4" MPT	145°F
8.707-250.0		3/8" MPT	190°F
9.803-670.0		1/2" MPT	190°F

TRV Thermal Relief Valves

- Low profile
- Brass body
- Plastic-covered barb
- 7mm hose barb
- 145 PSI
- Opens at 145°



Part No	Old No	Inlet
8.712-547.0	458032	3/8"
8.712-548.0	458034	1/2"

Flow Meters

The answer to precision calibration and efficient operation of pressure washing systems.



- Flow scale measures gallons per hour (GPH)
- 100 PSI
- 150°F
- 1/8" FPT inlet and outlet port
- Accurate within ±5%
- Precision-cut and machined-clear acrylic
- Metal mounting inserts for ease of installation (10-32 threads)
- Wetted parts are brass or stainless-steel, with or without metering values
- Compact size — 2" tall scale, 4-3/32" overall height



Part No	Old No	GPH	Metal	Metering Valve
8.710-097.0	343722	.6-5	Brass	No
8.710-098.0	343723	.6-5	Brass	Yes
8.710-101.0	343726	2-10	Brass	No
8.710-102.0	343727	2-10	Brass	Yes
8.710-099.0	343724	.6-5	Stainless-Steel	No
8.710-100.0	343725	.6-5	Stainless-Steel	Yes
8.710-104.0	343728	2-10	Stainless-Steel	No
8.710-105.0	343729	2-10	Stainless-Steel	Yes

NOTE: All flow measurements must be on low-pressure side of pump.

Rupture Disks

- Prevents dangerous thermal expansion of water in the coil
- Ensures operator safety



Part No	Old No	Description
9.802-192.0	2-3409	Assembly, 7000 PSI
8.707-381.0		Assembly, 8500 PSI

Safety Pressure Relief Valves



- Machined brass
- Automatically resets
- Prevents pressure overloads, protecting people and equipment



Part No	Old No	Max PSI	Size
8.722-192.0	G022550A	1200 (Silver Spring)	1/4"
8.722-193.0	G022560A	2400 (Red Spring)	1/4"
8.722-194.0	G022565A	3600 (Orange Spring)	1/4"
8.722-190.0	G022532A	3600 (Orange Spring)	3/8"
9.802-191.0	G022533A	5000 (Blue Spring)	3/8"

Air Valve – Coil Blow Out

Install in-line in front of coil and use air pressure to blow water out of coil to prevent "freeze-up".



- Threaded connection
- 1/8" model is stainless-steel
- 1/4" brass valve
- Valve cap included

Part No	Old No	Description
8.705-047.0	140073	1/8" Stainless-steel Connect
8.705-048.0	140075	1/4" Connect
8.902-426.0		Valve Assy, Water Blow-Out
8.707-314.0		Valve Assy, Water Tank Blow-Out

Easy-Start Val

- 1/8" FPT outlet
- Machined-brass housing
- Hose barb outlet
- Stainless-steel internal
- 200°F
- 8 GPM



Part No	Old No	Description
9.804-065.0		Easy-Start Valve, 1/4" MPT, 5000 PSI
9.802-190.0		Easy-Start Valve, 3/8" MPT, 5000 PSI
8.709-865.0	339004	Easy-Start Valve, 3/8" MPT, 4100 PSI
8.709-866.0	339005	Easy-Start Valve, 3/8" MPT, 3500 PSI
8.751-265.0		Valve, 5/16" HB Outlet, 5000 PSI
9.802-137.0	140352	Hose Barb, 1/8" x 1/4" barb

UNLOADERS, INJECTORS, VALVES & GAUGES

Easy-Start Valve

- 3/8" MPT inlet
- Hose barb outlet (8 mm)
- Machined-brass body
- Stainless-steel spring and ball
- 3200 PSI
- 176°F
- 7.8 GPM



Part No	Old No	Description
8.709-867.0	339006	Easy-Start Valve

Steel Utility Gauges

- Black lacquered steel case
- Bronze bourdon tube
- Dry gauge
- 1/4" NPT brass mounting stem
- Accuracy ± 3-2-3%



Part No	Old No	Pressure Range
2" bottom mount		
8.710-307.0	348552	0-60 PSI
8.710-308.0	348554	0-100 PSI
8.710-309.0	348558	0-200 PSI
8.710-310.0	348560	0-300 PSI

Fuel Oil Pressure Gauge

- 0-200 PSI
- Perfect for testing burner pump fuel pressure



Part No	Old No	Pressure Range
8.700-738.0	079020	0-200 PSI

Corrosion-Resistant ABS Gauge

- Acid and alkali proof plastic case
- 1/4" NPT brass mounting stem
- Accuracy - Dry: ±3-2-3%
- Accuracy - Filled: ±1.5%
- Bronze bourdon tube



Part No	Old No	Pressure Range
8.710-291.0	348305	0-100 PSI
8.710-293.0	348307	0-200 PSI
8.710-294.0	348308	0-300 PSI
8.710-295.0	348312	0-1000 PSI
8.710-296.0	348313	0-2000 PSI
8.710-297.0	348314	0-3000 PSI
8.710-299.0	348316	0-5000 PSI

Pressure Gauges

- 5000 PSI cold water
- 1-3/4" gauge
- 3/8" QC socket
- 3/8" QC plug



Part No	Description
8.712-208.0	Pressure Gauge Kit

Pressure Regulator

- Lowers city water pressure for better machine performance
- 10-125 PSI

Part No	Old No	Description
8.707-248.0	971443	Pressure Regulator

Stainless-Steel Pressure Gauges

- AISI 304 stainless-steel case
- Bronze bourdon tube
- 99.5% pure glycerin filled
- PSI and bar dual scale
- 1/4" NPT brass mounting stem
- Convex magnifying lens for easy reading
- Steel needle and peg
- Accuracy ± 1.5%



Part No	Old No	Pressure Range
2-1/2" Bottom Mount with Bronze Internals		
8.710-270.0	348216	0-100 PSI
8.710-272.0	348220	0-200 PSI
8.710-273.0	348224	0-300 PSI
8.710-276.0	348230	0-500 PSI
8.710-278.0	348240	0-1000 PSI
8.710-280.0	348245	0-2000 PSI
8.710-281.0	348250	0-3000 PSI
8.710-283.0	348255	0-4000 PSI
9.804-017.0	348260	0-5000 PSI
8.710-286.0	348262	0-6000 PSI
9.804-001.0	348265	0-10,000 PSI
2-1/2" Back Mount with Bronze Internals		
8.710-250.0	348140	0-100 PSI
8.710-254.0	348150	0-500 PSI
8.710-256.0	348152	0-1000 PSI
8.710-257.0	348154	0-2000 PSI
8.710-258.0	348156	0-3000 PSI
8.710-259.0	348158	0-4000 PSI
8.712-149.0		0-5000 PSI
8.712-150.0		0-6000 PSI
8.710-262.0	348162	0-6000 PSI
9.804-013.0	348165	0-10,000 PSI
Mounting Hardware for Back Mount Gauges		
8.710-223.0	348001	U-bracket
8.710-228.0	348090	3-hole flange, mounted

Stainless-Steel Pressure Gauges



Part No	Old No	Pressure Range
2-1/2" Back Mount with Bronze Internals		
8.710-246.0	348125	30Hg - 0 Vacuum Gauge
Mounting Hardware for Back Mount Gauges		
8.710-223.0	348001	U-bracket
8.710-228.0	348090	3-hole flange, mounted

Pressure and Temperature Test Set



Convenient test set provides both pressure and temperature check with one easy quick coupled connection at outlet of unloader or coil.

- Test Set 5000, 500°F thermometer 5000 PSI pressure gauge for systems up to 2000 PSI
- Test Set 10,000, 10,000 PSI pressure gauge for systems up to 5000 PSI



Part No	Old No	Description
8.904-559.0	449045	Test Set 5000 (0-2500 PSI systems)
8.904-558.0	449040	Test Set 10,000 (0-5000 PSI systems)

Speedmaster Throttle Control



Stop overworking the engine and pump during bypass. Decelerator reduces engine speed when pump head pressure drops below 215 PSI, reduces flow during bypass, slows recirculation heat build-up.

- 3500 PSI
- 300°F
- A major system saver for gas engine units
- Machined-brass body
- Stainless-steel gland components
- 1/4" male connect
- Viton seals
- 42" lined and covered control cable
- Engine speeds infinitely adjustable for "fine tuned" system performance



Part No	Old No	Description
8.903-840.0	339000A	Throttle Control

Temperature Gauges



Dial thermometers

- 3" diameter dial — stainless-steel case
- Shatter-resistant polycarbonate lens
- Stainless-steel stem (2.5")
- 1/2" MPT connector
- Accuracy to within 3% of dial range (50-500 = ± 6.8°F)



Part No	Old No	Description
8.712-488.0*	426410	Temp Gauge +50° to 500°F

*"Thermowell" to be used with dial thermometers in systems over 300 PSI. For best results, fill thermowell with liquid silicon or glycol to increase sensitivity and accuracy of readings.

Thermowell for temperature gauge above

- Stainless-steel 3/4" MPT x 1/2" FPT
- Gives 2000 PSI collapse protection
- 1.75" immersion length

Part No	Old No	Description
8.712-489.0	426423	Thermowell for 8.712-488.0

AMP and Voltmeters

- Designed for OEM or replacement
- Accuracy to ± 5%
- Metal case
- Rugged and weather-resistant
- Bright stainless bezel
- Utilize as constant monitor or as test instruments
- Fits 2-1/16" mounting hole



Part No	Old No	Description
8.701-686.0	091321	-15 to +15 Amps
8.701-687.0	091323	-20 to +20 Amps
8.701-688.0	091344	-60 to +60 Amps
8.712-159.0		Voltmeter 120V

Hour Meters for Gasoline Engines

- Elapsed time
- No battery required
- Digital quartz accuracy (± .02%)
- Extremely rugged and tamperproof
- Sealed from dirt and moisture
- Requires 2" panel cutout



Part No	Description
8.749-183.0	EL 5-80V AC/DC 50/60 Hz
8.749-316.0	EL 24-277 AC/DC 50/60 Hz
9.802-283.0	115/240V AC – Rectangle
8.904-540.0	Tach/Hour 12V DC w/ Magnet Tool

ENGINES, MOTORS & PULLEYS

Briggs & Stratton Engines – Gasoline

Briggs & Stratton's top-of-the-line engines have proven performance in the pressure washer industry. They contain the power to complete any job faster and easier with less wear and tear on major engine components

- Easy, quick-starting
- Large fuel tank
- Super-quiet muffler
- OilGuard® low-oil shutdown

Part No	Old No	HP	Shaft Diameter	Starter	Charge Rate	Fuel Tank	Model No.
8.754-819.0	-	18	1"	Electric	20 Amp	N/A	Vanguard
8.715-067.0	5-0316	21	1"	Electric	N/A	N/A	Vanguard

NOTE: Mufflers for the above engine are sold separately. See Briggs & Stratton Engine Parts section below.

- State-of-the-art carburetion system
- 30% quieter muffler than competition
- Cast/sintered iron sleeve
- OilGuard® low-oil shutdown

Part No	Old No	HP	Shaft Diameter	Starter	Charge Rate	Fuel Tank	Model No.
8.709-877.0	5-0313	11	1"	Recoil	N/A	2 gal	Vanguard



OHV Vanguard

Briggs & Stratton Engine Parts

Genuine Briggs & Stratton replacement parts are available. Please provide engine model/type/code to ensure proper fit of replacement parts.

- Authorized manufacturer replacement parts
- Don't settle for cheap imitations

Part No	Old No	Description
8.701-826.0	091960	Briggs 16/18 HP Vanguard, Oil Filter
8.701-820.0	091950	Briggs 5 HP Industrial, Air Filter
8.701-821.0	091952	Briggs 8 or 11 HP IC, Air Filter
8.701-823.0	091954	Briggs 16/18 HP Vanguard, Air Filter
8.718-021.0		Sparkplug, Vanguard, RC12YC



8.701-826.0



8.701-823.0



8.701-820.0



Honda Engine Parts

Original Honda replacement parts from the factory. Filters are a great add-on to every service order.

- Authorized manufacturer replacement parts
- Don't settle for cheap imitations

Part No	Old No	Description
8.701-830.0	091970	Honda 18/20 HP, Oil Filter
8.701-764.0	091746	Honda GX160, Air Filter
8.701-780.0	091775	Honda GX240/270, Air Filter
8.701-781.0	091777	Honda GX340, Air Filter
8.701-782.0	091779	Honda GX610/620, Air Filter (old style)
8.701-783.0	091779A	Honda GX610/620, Air Filter (new style)
8.718-117.0		Honda GX All, Sparkplug



8.701-764.0



8.701-830.0



8.701-782.0



8.701-783.0



Engines - Kohler Lombardini – Diesel

Kohler Lombardini Water Cooled Diesel Engines provide superior power and quiet operation.



- Diesel powered
- Water cooled

Part No	Old No	HP	Shaft Diameter	Starter	Charge Rate	Fuel Tank	Model No.
9.802-327.0	5-0407	27	1-1/2"	Electric	N/A	No	LDW1003, Water Cooled

Engine Parts - Kohler Lombardini



Factory direct Kohler parts.

- Authorized manufacturer replacement parts



Part No	Old No	Description	Engine Model
8.717-912.0	74-2175107	Oil Filter	LDW602/903/1003
8.717-915.0	74-2175164	Air Filter	LDW602/903/1003
8.717-909.0	74-2175045	Fuel Filter	LDW602/903/1003

Voltage Regulator - Heavy-duty 15 Volt

- Eliminates need for battery on 12 volt recoil Hot-Water Washers



Part No	Old No	Description
9.802-531.0	860273	Regulator, Voltage 15 Volts

Starter Solenoid - 12V DC

Universal type used on many lawn and garden tractors and mowers.

- Double terminal – 5/16" – 24 studs
- Same as used on 16 HP B & S Vanguard engines
- Rated for intermittent duty (i.e. for starting small gasoline engines)



Part No	Old No	Description
8.701-691.0	091357	12V DC Starter

Keyed Ignition Switch – 12V DC

- Universal style/5 pole
- Off-On-Start (spring back to On)
- Panel nut and star-lock washer
- Two keys included
- Has two auxiliary circuits
- Universal — used for small engine controls on many lawn and garden tractors, mowers



Part No	Old No	Description
8.701-689.0	091350	Keyed Ignition Switch, 5 pole
8.701-690.0	091351	Keyed Ignition Switch, 6 pole

Baldor Motors – C-Face Open Drip Proof (ODP)

Built to “industrial” specifications.

“S” indicates motor has on/off switch. “B” indicates motor is black.



Part No	Old No	Motor HP/S	RPM	Shaft Dia	Bolt Circle	Frame C-Face	Full Load Amps	Voltage
Single-Phase Motors								
8.709-754.0	337323B	3.0	3450	5/8"	5-7/8"	56/56C	13.7/12.5	208/230
8.709-723.0	337264B	3.0	1725	5/8"	5-7/8"	184CZ/56C	32/16	115/230
8.709-727.0	337268B	4.0	1725	5/8"	5-7/8"	182TCZ/56C	17.5/16	208/230
8.709-728.0	337269B	4.0	3450	5/8"	5-7/8"	56/56C	38/21/19	115/208/230
8.709-730.0	337271B	5.0	1725	1-1/8"	7-1/4"	184TC	25/23	208/230
8.709-731.0	337272B	5.0	3450	5/8"	5-7/8"	56HCY/56C	24/23	208/230
8.709-733.0	337273B	6.0	1725	1-1/8"	7-1/4"	213C/182TC	26	230
8.709-734.0	337275B	7.5	1725	1-1/8"	7-1/4"	215C/182TC	36/33	208/230
9.107-929.0		2	1725	5/8"		56C	16.4/8.2	115/230

Baldor Motors – Open Drip Proof (ODP)



Industrial-grade motors built specifically to meet or exceed the demands of the pressure washer industry.

- The industry standard
- U.L. Listed
- Any Baldor motor available



1 Phase 56 Frame



1 Phase 184T Frame



3 Phase 184T Frame

Part No	Old No	Motor HP	Voltage	RPM	Shaft Dia	Frame	Full Load Amps	Model
Single-Phase Motors								
8.754-710.0		2.0	115/230V	3470	5/8"	56C		35R613R717G1
8.754-709.0		2.0	115V	1750	5/8"	56C		35Q371R021G1
8.715-090.0	5-10081	3.0	208/230V	1725	5/8"	56HC		35M895T356
8.709-751.0	337320	3.0	115/230V	1725	1-1/8"	184T	32/16	
8.715-146.0	5-1053E	5.0	208/230V	3450	3/4"	56CZ		35L3583214G1
8.715-091.0	5-10104	5.0	230V	1725	7/8"	184TCZ		36G472W849
8.709-759.0	337331	5.0	208/230V	3450	5/8"	56	23-21	
8.709-757.0	337329	5.0	208/230V	1725	1-1/8"	184T	25/23	
9.802-336.0	5-10401	6.2	230V	1725	1-1/8"	184TZ		36J185X288G1
8.715-163.0	5-1080	8.2	208V	1725	1-3/8"	215		N/A
8.715-165.0	5-1082	8.2	230V	1725	1-3/8"	215		N/A
9.804-516.0		1.5	115V	1725	5/8"	56C	13.6	35R735R770G1
9.107-929.0		2	115/230V	1725	5/8"	56C	16.4/8.2	EPCL1322M
8.715-158.0		2.3	115V	1750	5/8"	56C	18	35Q899R328G1
8.715-144.0		5	200V	3450	3/4"	56CZ	24.5	35V142R510G1
8.715-142.0		5	230V	1725	1-1/8"	182TZ	23	36J800X811
9.802-337.0		6.2	200V	1725	1-1/8"	184TZ	30.7	36J468Y852
8.715-102.0		7.5	230V	1725	1-3/8"	215TZ	31	37H404W885G1
8.715-168.0		8.2	230V	3450	1-1/8"	184TZ	32.8	36E002Y277G1
8.725-973.0		8.2	230V	1740	1-3/8"	215T	34.5	37L276Y712G1
8.709-793.0		10	230V	1725		215TFC		
Three-Phase Motors								
8.751-004.0		6.2	208/230/460	1725	1-1/8"	184T		36B101Y483H2
8.751-014.0	337534	7.5	208/230/460	1770	1-3/8"	213T	20.4/19.4/9.7	
8.750-999.0		8.2	230/460V	1725	1-3/8"	215		N/A
8.751-009.0		5	575V	1750	1-1/8"	184T	5.2	EM3218T-5
8.751-010.0		7.5	575V	1770	1-3/8"	213T	7.8	EM3311T-5
8.751-005.0		8.2	575V	3450	1-1/8"	184T	7.4	36G548S515G1
8.751-011.0		10	575V	1770	1-3/8"	215T	10	EM3313T-5
8.751-008.0		20	575V	1765	1-5/8"	265T	18.9	EM2515T-5

NOTE: Amp draw ratings require adequate wire size and full voltage to apply. Full load Amp ratings apply only when full rated.

Motors – Totally Enclosed Fan Cooled (TEFC)

Featuring heavy-gauge steel frames, ball bearings, welded base, and “snap-action” starting for reliability. Built to industrial specifications.



Part No	Old No	HP	RPM	Shaft Dia	Bolt Circle	Frame / C-Face	Full Load Amps	Voltage
Single-Phase Motors								
8.709-767.0	337352	1.5	1725	5/8"	5-7/8"	56C	12/6	115/230
8.709-774.0	337363	2.0	3450	5/8"	5-7/8"	56C	17/8.5	115/230
8.709-779.0	337374	3.0	3450	5/8"	5-7/8"	56C	13.8/12.5	208/230
8.709-784.0	337380	5.0	1725	1-1/8"	7-1/4"	184TC	23	230
8.709-737.0	337280	7.5	1800	1-1/8"	7-1/4"	215C	34.1/30.8	208/230
8.723-881.0		2	1800	5/8"		56C	7.6/8.8	115/230
Three-Phase Motors								
8.751-016.0		10.0	1725	1-3/8"		215T	29-26/13	208-230/460
8.751-318.0		5	1725	1-1/8"	7-1/4"	184TC	13.4/6.7	230/460

NOTE: Some of these motors will require two days from order to shipping.

Motors - A.O. Smith – Pressure Washer

Excellent power efficiency. “S” indicates motor has on/off switch.



Part No	Old No	Motor HP/S*	RPM	Shaft Dia	Bolt Circle	Frame / C-Face	Full Load Amps	Voltage
Single Phase Motors								
8.709-808.0	337438	6.0	3450	7/8"	5-7/8"	56Y	22.0	208/230
TEFC Motor								
8.709-798.0	337407T	1.5	1750	5/8"	5-7/8"	56C/56C	15.0/7.5	115/230

Motors - WEG – Pressure Washer

Built to industrial specifications.



Part No	Moto HP	RPM	Shaft Dia	Frame	Voltage	Full Load AMPS
Three Phase Motors						
8.755-598.0	5	1760	1-1/8"	182/4T	200	14.6
8.755-599.0	10	1770	1-3/8"	213/5T	200	28.5
8.755-600.0	15	1775	1-5/8"	254/6T	200	42.8
8.755-601.0	20	1770	1-5/8"	254/6T	200	57.5
8.755-606.0	7.5	1770	1-3/8"	213/5T	200	21.3
8.756-431.0	20	1800	1-5/8"	254/6T	208/230	55.3-50.0/25.0
8.755-604.0	7.5	1770	1-3/8"	213/5T	208/230	20.5-18.5/9.25
8.755-605.0	10	1770	1-3/8"	213/5T	208/230	27.4-24.8/12.4
8.756-425.0	5	1800	1-1/8"	182/4T	208/230	14.0-12.7/6.33
8.756-429.0	15	1800	1-5/8"	254/6T	208/230	41.1-37.2/18.6

Small Engine Test Equipment

- Connects between plug and plug wire
- Totally contained spark
- Engine will run with tester attached
- Neon test light verifies proper ignition
- Handy tool allows safe, easy visual inspection of ignition output



Spark Tester

Part No	Old No	Description
8.701-680.0	091126	Spark Tester

- Designed for small engines
- 2-1/2" dial reads up to 300 PSI
- 12" flexible hose to reach spark plug holes
- Adapters for 14mm and 18mm spark plug holes
- Built-in pressure holding/release valves



Compression Tester

Part No	Old No	Description
8.701-682.0	091133	Comp Tester

- Terrific service aid for 1-cylinder engines
- Just hold built-in antenna near spark plug
- Two scales: 0-5,000 RPM or 0-15,000 RPM
- Solid-state electronics
- Requires 9V battery (not included)
- Excellent for setting GPM on pressure washers; accuracy within 2% of full scale



Wireless Tachometer

Part No	Old No	Description
8.701-681.0	091132	Wireless Tach

Couplers Built by Browning or Lovejoy

Listed as individual coupler sections (half) to allow flexibility in design. For complete coupler select: Bore size for motor + Bore size for pump + Spider = Complete Coupler



NOTE: Select halves from same series as listed in groups below (e.g. All "090/095", "099/100")

Part No	Old No	Description	Bore
090/095 Series: Up to 3 HP Electric or 4 HP Gas			
8.709-620.0	336031	Coupler Half	24mm
8.709-640.0	336050	Coupler Half	5/8" (090)
8.709-634.0	336044	Coupler Half	3/4" (090)
8.709-635.0	336045	Coupler Half	15/16" (090)
8.709-639.0	336049	Buna Spider for 090 (STD)	
099/100 Series: Up to 5-7 1/2 HP Electric or 5-13 HP Gas			
8.709-626.0	336038	Coupler Half	3/4" (100)
8.709-638.0	336048	Coupler Half	15/16" (099)
8.709-625.0	336037	Coupler Half	20mm(100)
8.709-627.0	336039	Coupler Half	24mm (099)
8.709-628.0	336039A	Coupler Half	24mm (100)
8.709-629.0	336040	Coupler Half	1" (100)
8.709-632.0	336042A	Coupler Half	1-1/8" (100)
8.709-637.0	336047	Coupler Half	1-3/8" (100)
8.709-633.0	336043	Buna Spider for 099/100 (STD)	

Pulleys

Fits Interpump, General and Admiral XLS, XDS Series pumps, plus XD3040, XD3047, XD3055 and XD3065.

- Double groove
- 24mm bore
- 2 x A groove



Part No	Old No	OD
8.711-115.0	376304	4.0"
8.711-116.0	376305	5.5"
8.711-117.0	376306	6.3"

Reference / Calculation Guide

Conversion Factors

1 inch = 25.4 mm	1 gal = 3.79 liter
1 cm = 0.394 inch	1 liter = 0.2642 gal
1 gal H2O = 8.33 lbs	1 kg = 2.205 lbs
1 oz = 23.35 gram	1 KW = 1.341 HP

Horsepower (HP) Equations

$$HP = \frac{GPM \times PSI}{1460} \quad PSI = \frac{HP \times 1460}{GPM} \quad GPM = \frac{HP \times 1460}{PSI}$$

How fast do I turn my pump to give me a desired GPM?

$$\text{Required RPM} = \frac{(\text{desired GPM} \times \text{Rated RPM})}{\text{Rated GPM}}$$

What size pump pulley do I use to get a certain RPM?

$$\text{Pump Pulley Diameter} = \frac{\text{Motor Pulley Diameter} \times \text{Motor RPM}}{\text{Pump RPM}}$$

V-Belts - Super "Gripnotch"



- Full line of belts
- "V"-notched for longer life and better performance

Part No	Old No	Size
8.715-669.0		AX26
8.710-727.0	369128A	AX28
8.715-672.0		AX29
8.715-673.0	369130A	AX30
9.804-026.0		AX31
9.803-896.0		AX33
9.802-407.0		AX34
9.803-683.0		AX35
9.802-408.0	369136A	AX36
9.802-409.0		AX37
9.802-410.0	5-602038	AX38
8.715-682.0	5-602041	AX41
9.802-411.0	5-602042	AX42
9.802-412.0	5-604022	BX22
9.802-413.0		BX32
9.802-414.0	369134B	BX34
9.802-415.0	369135B	BX35
9.802-416.0	369136B	BX36
8.715-698.0	369137X	BX37
8.710-745.0	369138B	BX38
9.802-418.0		BX39
8.715-701.0	369140B	BX40
9.802-419.0	369142B	BX42
8.710-754.0	369143B	BX43
9.802-421.0	369144B	BX44
8.710-756.0	369145B	BX45
8.715-706.0		BX46
8.715-708.0		BX48
8.715-710.0		BX51

Pulleys

High-quality cast-iron pulleys, Cast design, All sizes available



AK pulley



2AK pulley



BK pulley



2BK pulley



3TB pulley

Part No	Old No	Size	OD
8.715-517.0	5-40102158	AK21*	2.10"
8.715-519.0	5-40102358	AK23*	2.30"
9.802-368.0		AK25*	2.50"
9.804-028.0		AK28*	2.80"
8.715-524.0		AK30H	3.05"
8.715-527.0	5-40103201	AK32H	3.25"
8.715-530.0	5-40103401	AK34H	3.45"
9.803-898.0	5-40103901	AK39H	3.75"
9.802-369.0	5-40107401	AK74H	7.25"
8.715-538.0	5-40108401	AK84H	8.25"
8.715-539.0	5-40108901	AK89H	8.75"
9.803-298.0	5-40203001	2AK30H	3.05"
9.802-371.0	5-40203201	2AK32H	3.25"
9.804-047.0	5-40203401	2AK34H	3.45"
8.715-546.0	5-40204401	2AK44H	4.25"
8.715-548.0	5-40204901	2AK49H	4.75"
8.715-549.0	5-40205101	2AK51H	4.95"
9.802-372.0	5-40205401	2AK54H	5.25"
8.715-555.0	5-40206401	2AK64H	6.25"
9.802-374.0	5-40207401	2AK74H	7.25"
9.802-375.0	5-40208401	2AK84H	8.25"
9.803-548.0	5-40209401	2AK94H	9.25"
8.715-560.0		BK30H	3.30"
9.802-377.0		BK32H	3.35"
9.802-379.0		BK36H	3.75"
8.715-566.0		BK40H	3.95"
8.710-819.0	372586	BK45H	4.25"
8.710-823.0	372596T	BK47H	4.45"
8.710-831.0	372650T	BK52H	4.95"
8.715-567.0	5-40405701	BK57H	5.45"
8.710-837.0	372695	BK60H	5.75"
8.710-841.0	372704T	BK62H	5.95"
8.715-568.0	5-40406501	BK65H	6.25"
8.715-570.0		BK70H	6.75"
8.715-571.0		BK75H	7.25"
9.802-380.0		BK80H	7.75"
8.715-573.0		BK85H	8.25"
8.710-858.0	372799T	BK100H	9.75"
8.715-576.0		2BK32H	3.35"
8.710-811.0	372499T	2BK34H	3.55"
9.802-383.0		2BK36H	3.76"
9.802-384.0		2BK40H	3.95"
9.802-385.0		2BK45H	4.25"
8.715-582.0		2BK47H	4.45"
8.715-583.0	5-40505001	2BK50H	4.75"
9.802-386.0		2BK52H	4.95"
9.802-387.0		2BK60H	5.75"
8.715-588.0		2BK62H	5.95"
9.804-060.0	5-40506501	2BK65H	6.25"
9.802-388.0	5-40506701	2BK67H	6.45"
8.715-591.0		2BK70H	6.75"
9.802-389.0	372774T	2BK80H	7.75"
8.715-593.0	372790T	2BK90H	8.75"
9.802-391.0		2BK100H	9.75"
8.715-598.0	5-406040	2TB40	4.35"
9.802-392.0	5-407034	3TB34	3.75"
9.802-394.0	5-407040	3TB40	4.35"

*x 5/8" Bore

Pulley Bushings

Split taper "H"



- Split taper, malleable iron
- Keyed to both shaft and hub
- Highest torque carrying capacity

For use with "H" sheaves, above.

Part No	Old No	Size
Motor / Engine Bushings		
9.802-397.0		H x 5/8"
9.803-897.0		H x 3/4"
8.715-633.0		H x 7/8"
9.802-399.0		H x 1"
9.802-400.0		H x 1-1/8"
9.802-401.0		H x 1-3/8"
8.715-638.0	5-511139	H x 1-3/8"-6B, Spline
Pump Bushings		
8.711-118.0	376320	H x 20mm
8.711-119.0	376322	H x 22mm
8.711-121.0	376324	H x 24mm
8.711-122.0	376325	H x 25mm
8.711-123.0	376330	H x 30mm
8.711-124.0	376332	H x 32mm
8.711-125.0	376335	H x 35mm

BURNERS

Oil Burners - 115V / 230V



- .4 to 3 GPH firing rate
- 6-1/4" blower fan 115V and 230V
- 3,450 RPM pump/blower motor
- Solid-state ignition
- Beckett "CleanCut" fuel pump with oil valve
- Air tube 2-3/4"
- UL-recognized



Part No	Old No	Description
8.709-325.0	307032	Beckett AFG 115
8.709-326.0	307036	Beckett AFG 230

Beckett Burner Chart

BURNER

Part No	Old No	Description	Becket No.
8.709-326.0	307036	AFG / 240V AC	VMG202
8.709-325.0	307032	AFG / 120V AC	VMG902
8.709-327.0	307059	ADC / 13.5V DC - W/O ICB*	VMG504
8.709-328.0	307061	ADC / 13.5V DC - W/ICB	VMG505
8.717-071.0	N/A	SM / 120V	HO1501
8.717-090.0	N/A	SM / 240V	HO1301

MOTOR

Part No	Old No	Becket No.
8.750-518.0	22825U	
9.802-642.0	079602	21805U
9.802-638.0	079613	52145U
9.802-638.0	079613	52145U
8.701-090.0	079604	2364U
8.701-093.0	079609	21344U

BLOWER WHEEL

Part No	Old No	Becket No.
9.802-649.0	079517	2999U
9.802-649.0	079517	2999U
9.802-636.0	079518	2999AU
9.802-636.0	079518	2999AU
9.803-057.0	079515	2383U
9.803-057.0	079515	2383U

IGNITOR ASSEMBLY

Part No	Old No	Becket No.
8.751-780.0		5199701U
9.802-647.0	079669	51771U
8.751-784.0		5218301U
8.751-784.0		5218301U
9.803-060.0	079682	51824U
8.751-781.0		5199702U

BURNER

Part No	Old No	Description	Becket No.
8.709-326.0	307036	AFG / 240V AC	VMG202
8.709-325.0	307032	AFG / 120V AC	VMG902
8.709-327.0	307059	ADC / 13.5V DC - W/O ICB*	VMG504
8.709-328.0	307061	ADC / 13.5V DC - W/ICB	VMG505
8.717-071.0	N/A	SM / 120V	HO1501
8.717-090.0	N/A	SM / 240V	HO1301

* Ignition control board

FUEL PUMP

Part No	Old No	Becket No.
9.802-644.0	079642	2184403U
9.802-645.0	079641	2184405U
9.802-562.0	079643	2184402U
9.802-562.0	079643	2184402U
9.802-645.0	079641	2184405U
9.802-644.0	079642	2184403U

* Ignition control board

SOLENOID W/CORD SET

Part No	Old No	Becket No.
8.900-082.0	079054X	N/A
8.900-081.0	079053X	N/A
8.900-080.0	079050X	N/A
8.900-080.0	079050X	N/A
8.900-081.0	079053X	N/A
8.900-082.0	079054X	N/A

* Ignition control board

TUNE UP KIT

Part No	Old No	Becket No.
8.723-715.0	N/A	578730
8.723-715.0	N/A	578730
8.723-715.0	N/A	578730
8.723-715.0	N/A	578730
8.723-715.0	N/A	578730
8.723-715.0	N/A	578730

* Ignition control board

Oil Burner - 14V ADC

- 14V, solid-state ignition
- 1/6 HP
- 3,450 RPM
- 4-1/4" fan
- Beckett "CleanCut" fuel pump with oil valve
- Max rate 2.5 GPH

Part No	Old No	Description	Oil Valve	Electric Eye	Motor RPM
8.709-327.0	307059	Beckett 13.5V	Yes	-	3450
8.709-328.0	307061	Beckett 13.5V	Yes	Yes	3450

NOTE: Proper operation requires an engine with 16+ Amp alternator and deep-cycle battery on nightly, overnight recharge



Flex Couplings

Part No	Old No	Beckett Part No	Description
9.802-648.0	079520	2454	5/16 "A"- (AFG)
9.803-058.0	079522	2433	5/16 "S"- (SF/SM)
9.802-637.0	079524	2140501U	1V DC ADC



Beckett Misc. Parts

Part No	Old No	Beckett Part No	Description
9.802-651.0			Burner Gasket AFG 120V
8.701-059.0		578726 SDC	Electrode Insul Assy
8.701-056.0	079530	149	Electrode Clamps (ALL)
8.701-063.0	079542	5432	Flange, w/ Gasket (ALL)
8.723-912.0	079543	5850	Flange, Split Uni A&S
8.701-070.0	079560	3616	Gasket, Universal AMF
9.802-653.0	079562	3416	Gasket, Unit Mtg
9.802-671.0	079592	5877	Burner Housing AFG/ADC
8.701-085.0	079595	5717 (51400)	Knurled Nut Kit ADC
8.701-134.0	079677	51304	Transf Mtg Gasket AFG
8.701-132.0	079674	31404	Transformer Clip
9.802-676.0	079654	7006U	Cadcell Flame det
8.701-137.0	079684	7556A0000	Primary Control, 14V DC
8.701-133.0	079675	3245	Transformer Spring
8.701-106.0	079629	AF90	Air Tube w/o Head
8.701-074.0	079573	5151501	Air Band (3 x 92 AFG)



Controller and Contractor Tool - Genisys™

Advanced burner control, 120V AC primary safety control for residential and light commercial oil burners.

Part No	Description
8.751-335.0	Genisys Controller
8.726-018.0	Genisys Contractor Tool



Electrode/Insulator Assembly

Part No	Old No	Beckett Part No	Description
9.802-668.0	079534	5780	Std to 9" AFG, SM, SF
8.717-978.0		578728	ADC
9.802-669.0			Electrode w/ Contact, PR
9.802-670.0			Electrode Kit



BURNERS

Oil Burners



Part No	Old No	Description
8.709-317.0	307000	115V AC Burner w/ Oil Valve
8.709-318.0	307003	230V AC Burner w/ Oil Valve
8.709-319.0*	307007	12V DC Burner w/ Oil Valve

*Proper operation requires an engine with 16+ Amp alternator and deep-cycle battery on nightly, overnight recharge

115V and 220V Wayne Burner Chart

- 75 to 3 GPH firing rates
- Solid-state ignition (low Amp)
- High-volume 6-1/4" blower on 220V unit, 5-3/16" blower on 110V unit
- 3,450 RPM pump/blower motor
- "A"-type Suntec fuel pump
- 3-3/4" air tube with adjustable flange for maximum versatility
- UL-recognized



115V Wayne Burner Chart

Part No	Description
8.709-317.0	Wayve 115V

Ignitor	Transformer	Motor	Blower Wheel
8.700-802.0 / 079111	8.700-804.0 / 079115	8.701-095.0 / 079612	8.700-730.0 / 079005

Fuel Pump	Solenoid Valve	Electrode Assembly	Tune Up Kit
8.700-749.0 / 079030	8.700-779.0 / 079030	8.700-770.0 / 079052	8.700-774.0 / 079056

220V Wayne Burner Chart

Part No	Description
8.709-318.0	Wayve 220V

Ignitor	Transformer	Motor	Blower Wheel
N/A / N/A	8.700-809.0 / 079123	8.701-094.0 / 079611	8.700-731.0 / 079006

Fuel Pump	Solenoid Valve	Electrode Assembly	Tune Up Kit
8.700-749.0 / 079030	8.700-780.0 / 079063	8.700-770.0 / 079052	8.700-774.0 / 079056

NOTE: 8.700-721.0 – Coupling for 8.700-740.0 FASCO motor used on MET to FASCO converted burner
 8.700-720.0 – Adaptor Bushing to allow MET blower wheel to work with FASCO motor
 8.700-740.0 – Conversion Kit — Use MET to FASCO conversion kit if 12V burner motor cannot be identified. The kit contains the following parts: 8.700-739.0 Motor; 8.700-720.0 Adaptor bushing; 8.700-682.0 Adaptor Plate; 8.700-721.0 Coupling; 8.700-691.0 Screws (2); 8.700-104.0 Nuts

12V Wayne Burner Chart

- 12V solid-state ignitor
- 3,450 RPM fuel pump
- .5 to 2.75 GPH capacity with oil valve

Part No	Description
8.709-319.0	Wayve 12V

Ignitor	Transformer	Motor
8.700-807.0 / 079120	N/A / N/A	8.700-739.0-FASCO / 079021 8.750-715.0-MET to FASCO 079021X

Blower Wheel
8.700-727.0 / (079003) FASCO - 2.44" W x 2.53" T, 5/16" shaft, 8.700-728.0 (079003A), MET 3.44" W x 4.25" T

Electrode Assembly	Tune Up Kit
8.700-770.0 / 079052	8.700-774.0 / 079056 with 8.700-721.0 coupling for converting from MET to FASCO



NOTE: 8.700-721.0 – Coupling for 8.700-740.0 FASCO motor used on MET to FASCO converted burner
 8.700-720.0 – Adaptor Bushing to allow MET blower wheel to work with FASCO motor
 8.700-740.0 – Conversion Kit — Use MET to FASCO conversion kit if 12V burner motor cannot be identified. The kit contains the following parts: 8.700-739.0 Motor; 8.700-720.0 Adaptor bushing; 8.700-682.0 Adaptor Plate; 8.700-721.0 Coupling; 8.700-691.0 Screws (2); 8.700-104.0 Nuts

Blower Wheel

Part No	Old No	Wayne Part No	Description	Shaft Size
8.700-730.0	079005	20288/SER	5-3/16" x 3-7/16"	1/2"
8.700-731.0	079006	21854/SER	6-1/4" x 4-3/16"	1/2"
8.700-726.0	078999	20673	4-1/4" x 3-1/8"	1/2"
8.700-727.0	079003	21427/SER3	12V (Fasco)	5/16"
8.700-728.0	079003A	21427	(MET)	1/2"



Common Parts – Beckett & Wayne

Part No	Old No	Description
8.701-054.0	079526	Oil Line, 6.5", Copper
9.802-667.0	079058	Oil Line, 8", Copper
8.701-053.0	079525	Oil Line, 9.5", Copper
8.700-784.0	079066	Brass 90° Elbow 1/8" flare, 1/8" MPT
8.700-785.0	079067	Brass 90° Elbow 3/16" flare, 1/8" MPT
8.700-738.0	079020	Oil Pressure Gauge 0-200 PSI
8.700-768.0	079051	(28737-1) Nozzle Adapter
8.705-063.0	140150	Straight Thru Double Nipple 1/8" x 1/8"

Brass Elbow



Oil Line

Wayne Burner Parts

Part No	Old No	Wayne Part No	Description
8.700-774.0	079056	31156	Wayne Burner Tune-up Kit
8.700-770.0	079052	14733-001	Electrode Assembly (Pair)
		14734-002	with Buss Bars – G shape
8.700-743.0	079024	12945	Buss Bar – G shape
8.700-754.0	079034	14344	Burner Gasket
8.700-692.0	078785	12484	Universal Gasket
8.700-735.0	079014	4725	Burner Housing (E-Series)
8.700-736.0	079016	2689	Burner Flange "F"
8.700-776.0	079059	13279	Flex Coupler A Fuel Unit
8.700-777.0	079060		Coupler End (J Pump 7/16")
8.700-733.0	079010	13360	Trans Clip Screw
8.700-734.0	079011	13038	Trans Clip
8.700-729.0	079004	2668	Outer Air Band (8 Hole)
8.700-732.0	079007	2669	Inner Air Band (8 Hole)
8.700-714.0	078979	31702-014	Gun Assy, F/307007
8.700-680.0	078752		Nzl Adapter w/legs MSR/DC



Burner Motors

Part No	Old No	Capacitor	RPM	HP	Flange	Voltage	Wayne / Beckett
9.802-642.0	079602	Y	3450	1/7	48M	115V	20627 / 21805U
8.750-518.0		Y	2850/3450	1/7	48M	220V	N/A / N/A
8.700-739.0	079021		4500	1/5	48M	12V DC	21993-005 / N/A
9.802-638.0	079613		3450	1/7	48M	13.5V	N/A / 52145U
8.701-090.0	079604		3450	1/4	48N	115V	N/A / 2364U
8.701-091.0	079605		3450	1/4	48N	12V	N/A / 52146U
8.701-093.0	079609	Y	3450	1/4	48N	115/240V	N/A / 21344
8.701-094.0	079611		3450	1/5	48N	240V	21328 / 21173U
8.701-095.0	079612		3450	1/5	48N	115V	20554 / 2900U
8.700-740.0	079021X	Kit, 12V DC/MET to Fasco					
Universal							
8.700-741.0	079022		3450	1/7	48M	110-60 Hz	
8.700-744.0	079025		3450	1/5	48N	110/240V	Capacitor Start



48M 5.75" Dia.



48N 7.25" Dia.

BURNERS

Beckett Tune-Up Kit

Fits all Beckett Burners with 3" or 3-5/8" air tube.

- Kit contains:
- Four Beckett electrodes
- Two couplings
- One fuel line
- T-gauge



Part No	Description
8.723-715.0	Beckett Burner Tune-up Kit

Blower Wheels



Part No	Description	Shaft Size
9.803-057.0	6-1/4" D x 3-7/16" W	1/2" SF-SM
9.802-649.0	4-1/4" D x 2-1/2" W	1/2" AFG
9.802-636.0	4-1/4" D x 2-7/16" W	5/16" ADC

Fuel Conditioner and Soot Remover

Red Devil eliminates soot build-up.

- Easy to use — just add to burner fuel
- Keeps burner at top efficiency
- 1 oz. per 10 gallons



Part No	Old No	Description
8.704-625.0	112057	Pint (16 oz)
8.704-626.0	112059	Quart
8.719-158.0	9-4007	Soot-O-Magic Stick

Fuel Pumps

- Use with single- or dual-line systems
- Pressure adjustment valve

Part No	Old No	Suntec PN	GPH	RPM	Rotation
Standard Pumps					
8.700-749.0	079030	A2VA7116	3	3450	RH
8.700-789.0	A2VC7118		3	3450	LH
8.700-756.0	079031	A1YA7912	7	1725	RH
8.700-757.0	079037	A2YA7916	7	3450	RH
8.700-748.0	079028	A2RA7710			RH
Pumps with Solenoid					
8.700-758.0	079038	A2VA3106-N221R w/12V	4	3450	RH
8.700-759.0	079038-110	A2VA3106-N621L w/110V	3	3450	RH
8.700-760.0	079038-220	A2VA3006-N721RS w/220V3		3450	RH
Pump Replacement Parts					
8.700-764.0	079044	3715732 (A2VA 7116)			Pump Fuel Screen
8.700-772.0	079055	3715744 (A2AVA 7916)			Pump Fuel Screen
8.700-765.0	079045	3779801			Gasket Cover



CleanCut Fuel Pump

Simple design provides faster cleaning, more reliable cut-offs, and cut-ons. Cleaner operation — less soot. More reliable — fewer moving parts. Reduced motor load in start-up. Higher capacity — 4 GPH at 100 PSI.

- 100-200 PSI — factory set 100 PSI
- Inlet pressure 10 PSI
- Rated speed 3,600 RPM
- Includes built-in solenoid w/ cord set



Part No	Old No	Description
9.802-645.0	079641	110V
9.802-644.0	079642	220V
9.802-562.0	079643	12V
9.802-646.0	079690	Valve Stem Kit (21877U)

Burner Ignitors

- Solid-state technology
- 14,000V spark
- Only .35 Amp @ 110V
- 1.7 lbs



Part No	Old No	Beckett Part No	Mounting	Volt
9.802-647.0	079669	51771U	AFG/Lo Amp	120V
8.751-785.0	079707	517780	SDCw/ Con BD	12V DC
9.803-060.0	079682	51824U	SM/SF	120V
8.701-140.0	079687	51779U	SDCw/o CB	12V DC

*Complete with timer

Burner Transformers

- 10,000V spark
- 2.2 Amp @ 120V
- 8.5 lbs
- Traditional copper-wire wound



Part No	Old No	Beckett Part No	Mounting	Volt
9.802-661.0*	079668	51343U	AFG	240V
8.701-125.0*	079662	21376U	S-SF-SR-SM	120V
9.803-055.0*	079665	21176U	SM	240V

* Bottom mount

Base Plates for Igniters



Part No	Old No	Description
8.701-116.0	079644	A, Trans/Ign
8.701-117.0	079645	S, Trans/Ign
8.701-118.0	079646	E, Trans/Ign
8.701-119.0	079647	M, Trans/Ign

Nozzle Accessories



Part No	Old No	Description
8.700-849.0	079221	Nozzle Tray (Metal) (Open Top, 55-Compartment, Plastic)

Burner Transformers

- 10,000V spark
- 2.2 Amp @ 120V
- 8.5 lbs
- FranceFormer



Part No	Old No	Wayne Part No	Mounting	Volt
8.700-804.0	079115	23101/E	Side/EH-EHA	120V
8.700-806.0	079117	23101/M	Back/M-MSR	120V
8.700-809.0	079123	23103/E	Side/EH-EH	230V
8.700-810.0	079124	23103/M	Back/10KVA	240V

Burner Igniters

- Solid-state technology
- 14,000V spark
- Only .35 Amp @ 120V
- 1.7 lbs



Part No	Old No	Wayne Part No	Mounting	Volt
8.700-802.0	079111	101122/001	Side/EH-EHA, France	120V
8.700-803.0	079113	101121/001	Back/M-MSR, France	120V
8.700-800.0	079107	31813-002	Side/EH-EHA, Allanson	220V
8.700-801.0	079109	31812-002	Back/M-MSR	220V
8.700-807.0	079120	31812-003	Rear Mount, Carlon	12V
8.700-820.0	079152	31813003	Side Mount(E)	12V

Fuel Solenoid Valve - 12V DC KIP

- Brass body
- 12V DC coil
- 1/8" FPT I/O ports
- Conduit connector
- 5/64" orifice = 6 watt



Part No	Old No	Description
8.701-120.0	079652	Fuel Solenoid Valve

Smoke Tester – Diagnostic Tool

The smoke tester gives you the ability to measure smoke (soot) density and adjust air flow and fuel pressure to optimize burner performance.

- A properly tuned burner:
- Heats water more efficiently
- Doesn't build up soot in the coil
- Doesn't pollute the air
- Keeps your customers happy
- A tool that should be used by every serviceman in the industry



Part No	Old No	Description
8.712-507.0	449020	Smoke Tester
8.712-506.0	449019	Filter Paper Refill*

*40 sheet (10 tests per sheet)

BURNERS

Oil Solenoid Valve

- Unitized mounting on Suntec fuel pumps
- 1/8" FPT inlet
- 300 PSI
- Uses standard Suntec coil



Part No	Old No	Description
8.700-779.0	079062	110V Oil Valve – R642
8.700-780.0	079063	220V Oil Valve – R753
8.700-782.0	079064	12/24V Oil Valve – R261
8.700-811.0	079125	Flow-Thru Connector Bolt
8.700-812.0	079126	Aluminum Seal Washer
8.900-081.0	079053X	110V Coil w/ Cord Set
8.900-082.0	079054X	230V Coil w/ Cord Set
8.900-080.0	079050X	12/24 Coil w/ Cord Set
9.802-640.0	079096	115V Coil w/o Cord Set
9.802-641.0	079097	230V Coil w/o Cord Set
8.700-794.0	079098	12/24V DC Coil w/o Cord Set
8.700-795.0	079099	Cord Set Only
8.900-079.0	079047	8mm Nut for Old Style Coil

Gas Burner Rings – N/G or L/P Gas Jets

The standard for gas-fired pressure washers. Impinged jet burner rings offer the most efficient utilization of gas for heating water.



Gas Burner Ring

Part No	Old No	Model No.	Jets Req'd	1000 BTUH
Gas Burner Rings Only				
8.710-203.0	347502	Z-21	20	100-200
8.710-204.0	347504	X-11	32	160-320
8.710-207.0	347506	X-44	44	220-440
8.710-210.0	347508	X-66	66	330-660
8.904-003.0	347510	X-88	88	440-880



Gas Jets

Part No	Old No	Drill Size	Orifice Size	Use
Gas Jets for Burner Rings* (above)				
8.710-215.0	347552	#52	(.0635)	NG
8.710-216.0	347554	#54	(.055)	NG
8.710-217.0	347562	#62	(.038)	LP
8.717-377.0		#63	(.037)	LP
8.710-218.0	347565	#65	(.035)	LP
8.710-219.0	347566	#66	(.033)	LP
9.802-684.0		#69	(.029)	LP
8.710-214.0	347549	Blank (Must Be Drilled)		

*Due to freight damage on assembled rings/jets, separately order correct number and size of jets for each burner ring.

Valves - Honeywell Gas

Natural Gas – Small Millivolt Valve

Part No	Old No	Description
9.803-615.0	7-7000CH1	Natural Gas Millivolt Valve, 3/4" NPT
9.803-617.0	7-7CH1	Pilot for Piezo Ignitor
9.803-611.0	7-70360	47" Powerpile
9.803-614.0	7-70232	LP Conversion Kit (NG to LP)
8.718-116.0	7-7078	NG Conversion Kit (LP to NG)



9.803-615.0

Natural Gas – Small Electronic Ignition Valve

Part No	Old No	Description
9.803-616.0	7-700021	Natural Gas Electronic Ignition Valve, 24V, 3/4" NPT
9.803-618.0	7-702320	LP Conversion Kit (NG to LP)
8.718-112.0	7-70700	NG Conversion Kit (LP to NG)



9.803-616.0



8.718-048.0



9.803-612.0

Natural Gas/LP – Large Electronic Ignition Valve

Part No	Old No	Description
8.718-050.0	7-70003	Natural Gas Electronic Ignition Valve, 24V, 1" NPT (no LP conversion kit)
8.718-048.0	7-700022	LP Gas Electronic Ignition Valve, 24V, 1" NPT (no NG conversion kit)
9.803-612.0	2-990581	Solenoid Pilot

See Electronic Ignition Parts below.



9.803-613.0



9.803-610.0

Electronic Ignition

Part No	Old No	Description
9.803-613.0	7-701510	Electronic Ignition Controller Black 90 sec TFI
9.803-610.0	7-702371	Pilot, Electronic Ignition
9.803-562.0	6-01352	48" Ignition Cable
8.905-681.0	6-01353	60" Ignition Cable
8.930-332.0		69" Ignition Cable

Gas Regulators

■ A.G.A. Design Certified

■ CGA Certified

Part No.	Org No.	Size	Voltage	Model No.	Brand
Natural Gas					
9.803-616.0	7-700021	3/4"	24V	VR8304M4002B	Honeywell
8.710-182.0	924895	3/4"	115V	36C03A41S1	White Rodgers
8.717-766.0	924904	3/4"	Millivolt	VS820A-1005	Honeywell
8.717-767.0	924908	3/4"	24V	V800A1328	Honeywell
8.718-099.0	921431	3/4"	24V	SV9601M4167	Honeywell
8.717-768.0	924870	1"	24V	700-44J	Robert Shaw
8.710-174.0	860192	1"	24V	70-05J	Robert Shaw w/ Pilot
9.802-674.0	971495	1"	24V	7000 DERHC, 5N2501531	Robert Shaw
LP Gas Regulator Conversion Kits					
8.718-111.0	924897		Fits White Rogers - 924895, 924896		
8.718-113.0	924913		Fits Honeywell - 924904, 924908		
9.803-618.0	7-702320		Fits Honeywell - 921431		
9.802-688.0	924868		Fits Honeywell - 971495		
8.710-162.0	924900		Fits Robert Shaw - 924870		
8.710-187.0	860123		Fits Robert Shaw - 860192		

Propane Gas Regulators

■ High quality Fischer regulators

■ High and low pressure

Part No.	Old No	Description
8.717-752.0	860283	LP, FPOL x 3/4" FIP
8.717-746.0	7-1005	High Pressure
8.717-747.0	7-10050	Low Pressure
8.717-749.0	7-10052	Regulator, Propane Gas, Fisher
9.802-633.0	7-1010	LP Assembly, includes High/ Low Pressure Assy

Draft Diverters & Rain Caps

■ Prevents backdrafts, keeps cold air out

■ Prevents water from running down vent pipes

■ Fits on standard stove pipe

■ Hot dipped galvanized



Part No.	Old No	Description
8.717-764.0	924889	8" Oil Fired, Barometric Dampener
8.717-728.0*	835526	8", Round Gas-Fired
9.801-040.0*	835525	10", Round Gas-Fired
8.717-730.0*	835531	12", Round Gas-Fired
Rain Caps		
8.717-731.0	7-10033	10", Exhaust Stack, Cap
8.717-732.0	7-10034	12", Exhaust Stack, Cap

*Available from Springdale and Camas

BURNERS

Propane Gas Hose

Part No.	Old No	Description
8.711-853.0	867210	LP 1/4" x 10' POL x POL
8.711-856.0	707127	LP 1/2" x 48" 1/2 MNPT BE
8.711-854.0	707431	LP 1/4" x 18" MPOL BE
8.711-864.0	707432	LP 3/4" x 16" MNPT BE

Propane Tanks

Part No.	Old No	Description
8.717-791.0	891113	Tank, 43# - without OPD valve

NOTE: No Air Freight shipments on the above items

Gas Valves - 1" by Robert Shaw

Universal type for new equipment or replacement.

- Manual gas cock
- Auto-pilot safety valve
- Wiring and hardware included
- Pilot gas filter
- 600,000 BTU LP gas 720,000 BTU -tural gas
- 1" inlet/outlet



***Kit is for 8.710-174.0 and includes: gas valve, flame sensor, electrode pilot relight and harness**

Part No	Old No	Description
8.710-178.0	347406	240V AC/NG, Standing Pilot
8.710-179.0	347407	24V AC/NG, Standing Pilot
8.710-174.0	347403	24V AC/NG, Electronic Ignition
8.710-181.0	347409	700 MV, Natural Gas
8.710-163.0*	347379	24V Retrofit Kit (NG) 720,000 BTU
9.802-677.0		Ignitor

LP Conversion Kit to right

Powered Damper



Part No.	Description
8.749-806.0	Powered Damper, 10"
8.753-171.0	Powered Damper, 12"
8.753-253.0	Powered Damper 8"
8.749-807.0	Wiring Harness

Gas Pilots



Part No.	Old No	Description
8.718-100.0	829858	Pilot Gas LP Gas Orifice HS
8.718-101.0	829977	Pilot Gas - Natural Gas Orifice HS
8.718-011.0	914162	Pilot Burner & Ignition
9.802-685.0	971496	Pilot Gas - Natural Gas
9.803-610.0	7-702371	NEW Pilot - Natural Gas

LP Conversion Kit for Robert Shaw

Convert NG to LP



Part No	Old No	Description
8.710-187.0	347421	1" LP Conversion Kit
8.710-164.0	347380	LP Orifice

Delavan Fuel Nozzles

Select proper size for maximum burner efficiency.



GPH	60° A Hollow Part No	60° B Solid Part No	70° A Hollow Part No	70° B Solid Part No	70° AR-D Part No	80° A Hollow Part No	80° B Solid Part No
.50	8.700-850.0	8.700-868.0	8.700-887.0	-	-	8.700-911.0	-
.60	8.700-851.0	-	-	-	-	8.700-912.0	8.700-932.0
.65	8.700-852.0	-	-	-	-	8.700-913.0	8.700-933.0
.75	-	8.700-870.0	-	8.700-896.0	-	8.700-914.0	8.700-934.0
.85	8.700-853.0	8.700-871.0	-	-	-	8.700-915.0	8.700-935.0
.90	8.700-854.0	8.700-872.0	-	-	-	8.717-333.0	8.700-936.0
1.00	8.700-855.0	8.700-873.0	8.717-276.0	8.700-897.0	8.756-261.0	8.700-916.0	8.700-937.0
1.10	8.700-856.0	8.700-874.0	-	-	-	8.700-917.0	8.700-938.0
1.20	8.700-857.0	8.700-875.0	8.700-890.0	-	-	8.700-918.0	8.700-939.0
1.25	8.700-858.0	8.700-876.0	-	8.700-899.0	8.756-262.0	8.700-919.0	8.717-350.0
1.35	8.700-859.0	8.700-877.0	-	8.700-900.0	-	9.802-584.0	8.717-358.0
1.50	8.717-328.0	8.700-878.0	8.717-278.0	-	8.756-263.0	9.700-921.0	8.717-351.0
1.65	8.700-861.0	8.700-879.0	-	-	-	8.700-922.0	8.700-943.0
1.75	8.700-862.0	8.700-880.0	8.700-892.0	8.700-903.0	8.756-264.0	8.717-329.0	8.717-352.0
2.00	8.700-863.0	-	-	8.700-904.0	8.756-265.0	8.700-924.0	8.717-353.0
2.25	8.700-864.0	8.700-881.0	-	8.700-905.0	-	8.700-925.0	8.700-946.0
2.50	8.700-865.0	8.700-882.0	8.700-893.0	-	-	8.700-926.0	8.700-947.0
2.75	8.700-866.0	8.700-883.0	-	-	-	8.700-927.0	8.717-330.0
3.00	-	-	8.700-894.0	-	-	8.700-928.0	8.717-354.0
3.25	8.700-867.0	-	8.700-895.0	-	-	-	8.700-950.0
3.50	-	8.700-884.0	-	-	-	8.700-929.0	8.700-951.0
4.00	-	-	-	-	-	8.700-930.0	8.700-952.0
4.50	-	-	-	-	-	-	8.717-367.0
5.00	-	-	-	-	-	-	8.717-357.0
6.00	8.700-999.0	-	-	-	-	-	8.700-956.0
6.50	-	-	-	-	-	-	8.700-953.0
7.00	-	-	-	-	-	-	-
8.00	-	-	-	8.700-910.0	-	-	8.700-957.0
8.50	-	-	-	-	-	-	8.700-958.0
9.00	-	-	-	-	-	-	8.700-959.0

“Snap” Fuel Nozzle Check Valve

Spring-loaded “snap” check valve replaces filter element on fuel nozzle. Valve opens when fuel pump pressure reaches 130 PSI and “snaps” shut when fuel pressure drops below 130 PSI. Stops “smokey” burners at start-up and eliminates “shutdown” after burn.



- Reduces nozzle fouling caused by residual fuel in orifice
- Easy field installation in standard fuel nozzles
- Reduces soot build-up in coil

Part No	Old No	Description	PSI
8.900-083.0	079210	Snap Fuel Valve	100
8.900-084.0	079211	Snap Fuel Valve	130
8.700-845.0	079215	Snap Check Valve, (5/pk)	130
8.700-844.0	079214	Snap Check Valve, (5/pk)	100

BURNERS

Delavan Fuel Nozzles - continued

Select proper size for maximum burner efficiency.



GPH	90° A Hollow Part No	90° B Solid Part No
.50	-	8.700-981.0
.60	8.700-960.0	-
.65	8.700-961.0	-
.75	8.700-962.0	8.700-982.0
.85	-	8.700-983.0
.90	8.700-963.0	-
1.00	9.802-583.0	8.700-984.0
1.10	8.717-332.0	8.700-985.0
1.20	-	-
1.25	8.700-966.0	8.700-986.0
1.35	8.700-967.0	8.700-987.0
1.50	9.802-585.0	8.700-988.0
1.65	8.700-969.0	8.700-989.0
1.75	8.700-892.0	9.802-575.0
2.00	8.700-970.0	9.802-576.0
2.25	8.700-971.0	9.802-577.0
2.50	8.700-972.0	9.802-586.0
2.75	8.700-973.0	8.700-994.0
3.00	8.700-974.0	8.700-995.0
3.25	8.700-975.0	8.700-996.0
3.50	8.717-336.0	8.700-997.0
4.00	8.700-977.0	8.700-998.0
4.50	8.700-978.0	-
5.00	-	-
6.00	8.700-979.0	8.701-000.0
6.50	-	-
7.00	-	-
8.00	-	-
8.50	-	-
9.00	-	-

Part No	Old No	GPH
8.701-018.0	079477	2.00 x 60°W
8.701-021.0	079480	1.50 x 80°W
8.701-020.0	079479	1.65 x 80°W
8.701-023.0	079481	1.75 x 80°W
8.717-342.0	079482	2.00 x 80°W
8.701-025.0	079483	2.25 x 80°W
8.701-026.0	079484	2.50 x 80°W
8.701-027.0		1.25 x 80°W
8.701-028.0	079486	2.75 x 80°W
8.701-029.0	079487	3.00 x 80°W
8.701-031.0	079490	4.00 x 80°W
8.701-039.0	079505	1.65 x 90°W
8.701-032.0	079492	2.00 x 90°W
8.723-697.0		0.85 x 80°W
8.723-698.0		0.90 x 80°W
8.701-006.0		1.00 x 90°W
8.723-699.0		1.10 x 80°W
8.723-700.0		1.20 x 80°W
8.740-139.0		1.25 x 60°W
8.701-027.0		1.25 x 80°W
8.701-007.0		1.35 x 60°W
8.723-701.0		1.35 x 80°W
8.701-037.0		1.35 x 90°W
8.701-015.0		1.50 x 60°W
8.701-038.0		1.50 x 90°W
8.701-016.0		1.65 x 60°W
8.701-017.0		1.75 x 60°W
8.701-013.0		2.25 x 45°W
8.701-019.0		2.25 x 60°W
8.701-034.0		2.25 x 90°W
8.701-026.0		2.50 x 80°W
8.701-028.0		2.75 x 80°W
8.701-035.0		2.75 x 90°W
8.701-030.0		3.25 x 80°W
8.701-036.0		5.50 x 80°W

NOTE: The above "W" nozzles are stocked — all sizes are available.

Gas Valves – LP or Natural

Universal-type for building new systems or field replacement. 750 MV, 24V or 120V controls by White-Rodgers.

- 335,000 BTU max
- 3/4" inlet/outlet
- All adjustments and wiring connections on top of valve
- Automatic outlet pressure regulator
- A.G.A.-design certified, C.G.A.-certified



Part No	Old No	Description
8.710-172.0	347400	Gas Valve 24V (1)
8.710-182.0	347410	Gas Valve 120V (2)
8.710-183.0	347412	Gas Valve 750 MV (1)
8.750-110.0		3/4" NG to LP Conversion Kit
8.750-109.0		3/4" LP to NG Conversion Kit

- (1) Includes two 3/4" x 1/2" all-thread plated bushings and valve instructions.
 (2) Includes L.P. Kit, two 3/4" x 1/2" and one 1/2" x 3/8" all-thread plated bushings and all instructions.

White-Rodgers Repair Parts

Part No	Old No	Description
8.710-184.0	347416	24V Cycle Pilot Control (347425)
8.710-197.0	347440	120V Cycle Pilot Control
8.710-198.0	347446	Gas Ignition Electrode (24" Lead)

Gas Valve Accessory Components

Use with both 3/4" and 1" models on this page.



8.710-190.0

Part No	Old No	Description
8.710-190.0	347430	750 MV Generator
8.710-191.0	347431	P110T Pilot Burner (-tural gas)
8.718-092.0	347436	Thermo Couple (w/ 24") Cap Tube
8.710-196.0	347438	Thermo Couple (w/ 36") Cap Tube
9.802-686.0		Thermopile, VNG, 44

Insulation and Rigid Disc/Donuts

Refractory-grade ceramic kaowool formed; retains heat inside coil for better fuel efficiency and paint protection.

Part No	Old No	Description	Thickness	Width	Length
"Rigid Formed" Donut and Discs					
8.704-807.0	122253	Donut	.88"	18"	6 7/4.4"
8.704-810.0	122258	Donut	.88"	16"	6 7/4.4"
8.717-474.0		Donut		24"	
8.704-808.0	122254	Disc	1/2"	18"	
8.704-809.0	122257	Disc	1/2"	16"	
8.717-475.0		Disc		24"	
Insulation Blanket					
8.901-288.0	122204	Coil Wrap	1"	24"	4'
8.901-289.0	122205	Coil Wrap	1"	24"	5'
8.704-800.0	122206	Coil Wrap	1"	24"	6'
8.704-802.0	122222	Full Roll	1/2"	24"	37.5'
8.704-805.0	122225	Full Roll	1"	24"	25'



ELECTRICAL COMPONENTS

Legacy Flow Switch



- Horizontal or vertical mount
- 5000 PSI
- 10 GPM max flow, 1.8 GPM min flow
- 180°F
- 12-250V, 3 amps
- 3/8" FPT inlet/outlet
- 2 wire reed
- 62" cord length



Part No	Old No	Description
8.933-006.0		MV60, Vertical or Horizontal Mount
8.712-244.0		AP 500, Vertical Mount Only
9.803-266.0		Replacement Reed Switch (AP & MV)
9.803-266.0	109672	Reed Switch (AP) (2 wire)

Flow Switch

- Brass body
- 8 GPM
- 3600 PSI
- 3 Amp reed switch
- 180°F
- 3/8" inlet / outlet ports



Part No	Old No	Description
8.712-243.0	410305	ST-5 Vert. Mnt Only (47" wire length)
8.712-245.0	410306	ST-6 Horiz. or Vert. Mnt (47" wire length)-
8.704-122.0	109675	ST-5 Reed Switch
8.704-121.0	109673	ST-6 Reed Switch

Legacy Flow Switch



Spring return float allows full mounting versatility

- 4050 PSI
- 3500 rated pressure
- Horizontal or vertical mount
- Forged brass body
- 3/8" MPT inlet/outlet
- 8 GPM
- 190°F
- One Amp switch
- Solenoid control



Part No	Old No	Description
8.712-246.0	410307P	Flow Switch

Flow Switch

- 12 GPM
- 5000 PSI
- Micro switch
- 176°F
- 3/8" inlet / outlet ports



Part No	Description
8.755-296.0	ST-7 Horiz. or Vert. Mnt (47" wire length)

Phoenix Flow Switch w/ Pilot

- 75-16.0 GPM
- 4000 PSI
- 165°F
- 3 Amp, 250V
- 96" reed cord
- Includes 8mm pilot
- 3/8" F inlet/outlet
- 2.5 lbs
- Mounting hole



Part No	Old No	Description
8.712-252.0	410320	Switch with Pilot
8.712-253.0	410322	Reed Switch

General Pump TMT Flow Switch

- 1.5 GPM @ 50 PSI
- 5000 PSI
- Minimal pressure drop up to 12 GPM flow
- 40-180°F
- 5 Amp, 250V
- 48" electrical lead length
- 3/8" F inlet/outlet
- 1.0 lbs
- Can be mounted in any position
- Activates with 1.5 GPM flow
- Micro-switch technology eliminates reed switch



Part No	Old No	Description
8.712-258.0	100934	Inline Flow Switch

Flow Switch - 7300 PSI Stainless-Steel

- 7300 PSI
- Stainless-steel
- 176°F
- 3/8" inlet/outlet
- 47" wire length
- 1-8 GPM



Part No	Old No	Description
8.723-665.0	87236650	ST-505 Flow Switch

Vac Switch – Burner Control

Normally open (NO) switch closes when pump vacuum begins drawing water and opens when vacuum is broken due to pump shutdown or empty water tank.

- 1/4" FPT connect
- Heavy-duty 16 Amp contacts
- 140°F max water temperature



Part No	Old No	Description
8.712-391.0	413031	1.5" (HG) Vac Switch
8.712-392.0	413032	2.5" (HG) Vac Switch
8.712-393.0	413034	4.5" (HG) Vac Switch

Pressure Switch



Operation without opening switch case: Blue=Common
CONNECT: Red/Blue=N/C, Blue/Brown=N/O

- 200°F
- Stainless-steel plunger
- 360 PSI
- 1/4" and 3/8" MPT nipple
- 15 Amp — 115 or 230V AC
- 3-wire — internally wired for either N/O or N/C
- 42" wire length



Part No	Old No	Description
8.712-261.0	411060	Pressure Switch (Switches@360 PSI)
8.712-262.0	411060-40	P. Switch 1/4" MPT (Switches@580 PSI)
8.751-272.0		Pressure Switch 3/8"
8.701-311.0	082023	Micro Switch (15 Amp 115/230V AC)

NOTE: 10 AMP 28V DC Micro Switch available. Excellent for use on 12V DC Hot Pressure Washers.

Compact Pressure Switch

3-Amp rating provides the switching power to control fuel solenoids just like the large switches. Body measures 1" x 1-1/4" x 2" (not including wire or connector).



- 3600 PSI max rating
- 580 PSI switch pressure
- 200°F
- 1/4" brass MPT connect stainless-steel plunger
- 3 Amp switch rating – 250V
- 48" – 3-wire cable for use in either NC or NO application:
Blue = Common
Brown = NO
Red = NC

Part No	Old No	Description
8.712-260.0	411050	Compact Pressure Switch
8.712-270.0		Pressure Switch AL 3/8" Stainless 435 PSI

Black Pressure Switch

- Brass stem and stainless-steel nipple
- 3600 PSI
- 580 PSI switching pressure
- 45" wire length
- 195°F
- 1/4" male inlet
- 15 Amp
- Weight: 8 oz
- 250V



Part No	Old No	Description
9.802-458.0	6-021720	Black Pressure Switch

Red Pressure Switch

- All stainless-steel construction
- 5800 PSI
- 640 PSI switching pressure
- 44" wire length
- 195°F
- 3/8" male inlet
- 15 Amp
- Weight: 10 oz
- 250V



Part No	Old No	Description
8.712-267.0	411065	Red Pressure Switch
8.704-572.0	111459	Heavy-duty Micro Switch

ELECTRICAL COMPONENTS

Toggle / Push Button Switch

- 7/16" mounting bushing
- 1/2" diameter mounting hole required
- Mounting hardware included



Part No	Old No	Description	HP*	Connects
8.712-319.0*	411605	SPST, 20A/110V	1.0	m/spade
8.712-320.0	411607	DPST, 20A/110V		m/spade
8.709-705.0*	337206	DPST, 20A/125V	1.5	screw
8.709-704.0*	337205	DPST, 20A/250V	2.0	screw
8.709-054.0*	285140	SPST, 20A/120V	3/4	m/spade
8.709-065.0*	285189	DPST, 20A/120V	3/4	screw
8.716-078.0		SPST, 20A/120V	1.5	
8.709-706.0	337207	Switch Guard		
8.716-081.0		Waterproof Switch Protector		
Push Button Switches				
8.709-053.0	285139	SPST, 5A/120V Push on/ push off		screw
8.709-064.0	285187	SPST, 15A/120V Push and hold on/ release off		screw

*Motor rated

Toggle Switch - 30 AMP

- 30 Amp 600V – DPST
- With or without box
- Rated for: 2 HP motor @ 115V
3 HP Motor @ 230V



Part No	Old No	Description
8.709-696.0	337187	Switch only
8.903-802.0	337188	Switch and Rain Tight Box
8.709-708.0*	337210	Switch w/ NEMA 1 Box

*Not Rain Tight (Baldor Replacement)

High-Limit Switch



8.712-306.0

- Operates as safety device to shut off burner to prevent machine (water) overheating flashing to steam
- Does not turn back on until water has cooled 50°-70°F
- Normally used with other adjustable or fixed range thermostat which regulates water temperature
- 15 Amp @ 110V/10 Amp @ 220V
- Heavy-duty brass housing (7000 PSI collapse rating)
- UL/CSA-rated, bimetal switch components
- 1/4 male spade lug termi-ls
- 1/2" MPT external thread connects for attaching conduit or PVC wire connectors
- 4000 PSI

Part No	Old No	Probe MPT	Temperature
8.712-301.0	411254	3/8"	120°F
8.712-206.0		3/8"	140°F
8.753-450.0		3/8"	160°F
8.712-304.0	411262	3/8"	170°F
8.712-306.0	411266	3/8"	180°F
8.712-311.0	411276	3/8"	230°F
8.712-179.0		1/2"	180°F
8.712-308.0	411270	1/2"	210°F
8.712-298.0		1/2"	230°F
8.712-316.0	411332	1/2"	330°F
8.705-351.0	141538	1/2"	PVC Coupler

High-Limit Switch w/ Wire Lead



- Operates as safety device to shut off burner to prevent machine (water) overheating flashing to steam
- Does not turn back on until water has cooled 50°-70°F
- Normally used with other adjustable or fixed range thermostat which regulates water temperature
- 15 Amp @ 110V/10 Amp @ 220V
- Heavy-duty brass housing (7000 PSI collapse rating)
- UL/CSA-rated, bimetal switch components
- 1/4" male spade lug terminals
- 1/2" MPT external thread connects for attaching conduit or PVC wire connectors

Part No	Probe MPT	Wire Lead	Temperature
8.712-185.0	1/2"	42"	225°F
8.712-205.0	1/2"	42"	330°F

EATON Cutler-Hammer DP Contactors

- Cutler-Hammer quality
- Type C25 definite purpose contactors feature a compact, efficient design with low-VA coil
- Din rail mounting



Cutler-Hammer

Part No	Coil Voltage	FL Amps	Motor Hp @ 115V 1ph	Motor Hp @ 230V 1ph	Motor Hp @230V 3ph	Motor Hp @460V 3ph	Motor Hp @575V 3ph
8.724-267.0	24V	15	.75	2	3	5	5
8.724-264.0	115V	15	.75	2	3	5	5
8.724-265.0	230V	15	.75	2	3	5	5
8.724-266.0	460V	15	.75	2	3	5	5
8.724-269.0	24V	25	2	3	7.5	10	10
8.724-268.0	115V	25	2	3	7.5	10	10
8.724-270.0	230V	25	2	3	7.5	10	10
8.724-271.0	460V	25	2	3	7.5	10	10
8.724-275.0	24V	30	2	5	10	15	15
8.724-272.0	115V	30	2	5	10	15	15
8.724-273.0	230V	30	2	5	10	15	15
8.724-274.0	380V	30	2	5	10	15	15
8.724-280.0	24V	40	3	7.5	10	20	20
8.724-276.0	115V	40	3	7.5	10	20	20
8.724-277.0	230V	40	3	7.5	10	20	20
8.724-279.0	380V	40	3	7.5	10	20	20
8.724-278.0	460V	40	3	7.5	10	20	20
8.724-283.0	24V	50	3	10	15	30	30
8.724-281.0	115V	50	3	10	15	30	30
8.724-282.0	230V	50	3	10	15	30	30
8.724-286.0	24V	60	5	10	20	40	40
8.724-284.0	115V	60	5	10	20	40	40
8.724-285.0	230V	60	5	10	20	40	40
8.735-015.0	115V	65	5	15	25	50	60

XT Overloads for DP Contactors

Cutler-Hammer

- Cutler-Hammer quality
- Direct heated bimetal elements
- Adjustable trip current
- Manual/automatic reset



Part No	Amp Range
8.724-297.0	0.4 - 0.6
8.724-298.0	0.6 - 1.0
8.724-299.0	1.0 - 1.6
8.724-300.0	1.6 - 2.4
8.724-301.0	2.4 - 4.0
8.724-302.0	4.0 - 6.0
8.724-303.0	6.0 - 10.0
8.724-312.0	10.0 - 16.0
8.724-304.0	16.0 - 24.0
8.724-305.0	24.0 - 32.0
8.724-306.0	24.0 - 40.0
8.724-307.0	40.0 - 57.0

Push Button and Contact Blocks

Cutler-Hammer

- Cutler-Hammer quality
- Heavy-duty
- Water tight / oil tight



Part No	Old No	Model No.	Description
9.803-666.0	6-2004	CH C320KGS3	Contact Block, N/O, N/C
9.802-534.0	6-2000	CH E22B1	Contact Block, N/C
9.802-535.0	6-2001	CH E22B2	Contact Block, N/O
9.803-974.0	6-2021	CH E22PB3	Switch, Green Push Button
9.803-973.0	6-2022	CH E22EB2	Switch, Red Push Button
8.716-718.0	6-2023	CH E22VB51	Switch, 2-position Lever

Magnetic Motor Starters

For pressure washer and carwash applications.

- 24VAC Control
- 1Ø - 240V, 3Ø - 240V or 480V Contactor
- Componentized for flexibility
- Thermal overloads adjustable within range shown
- Electrical life: 1,000,000+ cycles
- Mechanical life: 20,000,000+ cycles
- Contacts: 90% silver, 10% cad-oxide



Contactors



Overload



Coil

Type	24V Coil Part No.	Old No	120V Coil Part No.	Old No	220V Coil Part No.	Old No	FL Amp	220V 1Ø HP	220V 3Ø HP	440V 3Ø HP
Contactors UL Rating										
A	8.708-753.0	260265	8.902-527.0	260290	8.902-532.0	260295	22	2	3	5
B	8.708-754.0	260266	8.902-528.0	260291	8.902-533.0	260296	24	2	5	7.5
C	8.902-523.0	260267	8.902-529.0	260292	8.902-534.0	260297	32	3	5	10
D	8.902-524.0	260268	8.902-530.0	260293	8.902-535.0	260298	40	5	7.5	15
E	8.902-526.0	260269	8.902-531.0	260294	8.902-536.0	260299	52	7.5	10	20
F	8.708-790.0	260351	8.708-791.0	260352	8.708-792.0	260353	90	10	15	30

Part No.	Old No	Voltage	Fits Contactor
Coils Only			
8.708-764.0	260274	24V	A,B,C,D
8.708-762.0	260272	120V	A,B,C,D
8.708-763.0	260273	220V	A,B,C,D
8.708-765.0	260275	480V	A,B,C,D
8.708-766.0	260277	120V	E
8.708-767.0	260278	220V	E

Part No.	Old No	Type	Amp Range	Fits Contactor
Thermal Overloads				
8.708-749.0	260253	Man	9.0-15	A,B,C,D
8.708-758.0	260270	Man	14-23	A,B,C,D
8.708-760.0	260271	Man	17-26	A,B,C,D
8.708-742.0	260247	Man	20-33	C,D
8.708-744.0	260248	Man	28-42	C,D
8.708-746.0	260249	Man	35-50	E,F
8.708-802.0	260433AUTO	Auto	2.0-3.3	A,B,C,D
8.708-803.0	260437AUTO	Auto	4.5-7.5	A,B,C,D
8.708-804.0	260440AUTO	Auto	6.0-10	A,B,C,D
8.708-750.0	260253AUTO	Auto	9.0-15	A,B,C,D
8.708-759.0	260270AUTO	Auto	14-23	A,B,C,D
8.708-761.0	260271AUTO	Auto	17-26	A,B,C,D
8.708-743.0	260247AUTO	Auto	20-33	C,D
8.708-745.0	260248AUTO	Auto	28-42	C,D
8.708-747.0	260249AUTO	Auto	35-50	E,F

- Used to mount Overload to Motor Starter Contactors

Part No.	Old No	Description
Thermal Overload Connector Kits		
8.708-768.0	260281	A,B,C,D
8.708-770.0	260284	E
8.708-789.0	260349	F

Relay Switch

Part No.	Old No	Description
8.716-087.0	875826	DPST NO 24VAC Omron 2000 Series

ON / OFF Rotary Switch

- Single or three phase
- 2 position or 3 position
- Heavy-duty



9.802-449.0

Part No.	Old No	Description
9.802-450.0	876028	2-position 115V/600V
9.802-449.0	876058	3-position 115V/230V 1PH 20 Amp
8.716-027.0	6-020203	3-position 230/460V, 3PH
8.716-030.0	950552	Rotary Switch

Molded Power Cord

- Water tight
- Factory finished look

Part No.	Old No.	Description
8.752-150.0	826024	3' 14/3 w/ Plug

Relays



9.802-468.0

8.716-230.0

9.802-467.0

9.802-470.0

8.716-264.0

Part No	Old No	Description
9.802-468.0	6-03621	120V, RH2B-UI-AC120 for Pressure Washers
8.716-209.0	6-03521	240V, RH2B-UI-AC240
9.802-467.0	6-03541	Base, SH2B-05 for IDEC
8.716-230.0	6-0367	24V, IDEC CLP
8.716-264.0	6-0381	Power Deltrol, 120V for SJ-5
8.716-257.0	6-0374	Relay, Power Omron G4B112T1FDCUSRPAC120 for Delta/Alpha
9.802-470.0	6-03671	P&B/VF4-41F11, 12V DC, 40 Amp for 12V DC Units 13 HP and Below
9.802-471.0	6-036711	Relay, P&B, 24V/40 A for 12V DC Units over 13 HP

Step-Down Transformers

- Industrial duty
- High-quality Cutler-Hammer
- Drops primary voltage to selected secondary voltage



8.716-899.0

9.802-553.0

8.716-904.0

Part No	Old No	Primary V	Secondary V	Size
8.716-593.0	6-05234	600V	120-240V	1.0KvA
8.716-899.0	6-6031	380/400/415	110/220V	.750KvA
9.802-553.0	6-60121	120/240V	24V	.050KvA
8.716-904.0	6-6035	120/240V	24V	.100KvA
8.716-883.0	6-60161	208/230/460V	24/115V	.050KvA
9.804-556.0	6-60141	208/277V	120V	.050KvA
8.716-882.0	6-60151	208/277V	120V	.075KvA
9.803-971.0	6-6025	380V	24V	.050KvA
8.716-875.0	6-60051	240/480V	120/240V	.200KvA
9.802-550.0	6-60021	240/480V	120/240V	.500KvA
9.802-552.0	6-60111	240/480V	120V	.075KvA
9.802-551.0	6-60101	240/480V	120V	.050KvA
9.803-668.0	6-60131	550V/575/600V	115V	.050KvA

Junction Boxes



9.802-474.0

8.716-269.0

8.716-271.0

9.802-475.0

9.802-476.0

9.802-477.0

8.716-280.0, 8.716-281.0, 8.716-272.0

8.716-320.0

8.716-321.0

8.716-322.0

8.716-326.0

Part No	Old No	Description
9.802-474.0	6-0390	VNG Remote, Plastic
8.716-269.0	6-03901	12" x 12" x 4", Metal VNG Remote Box
8.716-271.0	6-03904	Fiberglass, NEMA4 for PE Units
8.716-272.0	6-03906	12" x 10" x 5.25" for Solid Sep
9.802-475.0	6-03907	8" x 8" x 4", Plastic Alpha, for SEA 3-1100
9.802-476.0	6-03909	10" x 8" x 6", Box, Plastic with Lid for SEA
9.802-477.0	6-03910	Box, Plastic without Lid E9801
9.802-478.0	6-03911	Lid, Plastic for 9.802-477.0
8.716-280.0	6-03912	18" x 16" x 9.25", Plastic for CLP, WB
8.716-281.0	6-03913	14" x 16" x 6.75", Plastic for HBG, AMC
8.716-320.0	6-0409	Cover, Duplex Receptacle for Alpha
8.716-321.0	6-0410	2" x 4", 3-hole, 1/2" WB, for CLP
8.716-322.0	6-04101	2" x 4", Extension for 8.716-321.0, 8.716-323.0, 8.716-324.0
8.716-323.0	6-04102	2" x 4", 5-hole, 1/2" for CLP
8.716-324.0	6-04103	2" x 4", 4-hole, 1/2" for CLP
8.716-326.0	6-04104	4" x 4", 3-hole, SK Series for Alpha/ PK
8.716-327.0	6-041041	4" x 4", 5-hole, 1/2" for WB
8.716-329.0	6-041043	4" x 4" SK, Cover Plate, for WB for 6-00041
9.802-483.0	6-0411	2" x 4", Cover Plate, for 8.716-321.0
9.802-484.0	6-04110	2" x 4", Junction 3-hole, 3/4"
8.716-339.0	6-041100	2" x 4", 3-hole, 1" for ENG

ELECTRICAL COMPONENTS

Enclosure Box for Magnetic Motor Starter Sets

- NEMA 65 non-metallic enclosure dimensions: 4-1/3" W, 4" D x 6" H
- 8 (1/2"-3/4") wiring knockouts on box
- Holes pre-drilled for mounting contactor and overloads with mounting screws included



Part No	Old No	Description
8.902-525.0	260268X	Box, Toggle and Hardware

Manual Motor Starter w/ Sealed Box

- 25 Amp with adjustable overload
- Adjustment range 20-25 Amps
- Sealed box 3-1/4" W x 3-1/2" D x 6-1/2" H
- 110-500V IEC-rated
- Two-cord grips fit 1/2" threaded knockouts
- Protective cover over buttons
- Single and 3-phase wiring instructions



Part No	Old No	Description
8.709-709.0	337212	Motor Starter

RainTite Switch Box

- UL 728A
- 2-3/4" x 5-1/2" x 2" box
- Three 1/2" tapped holes
- Box includes two plugs, ground screw and mounting lugs
- Cover includes gasket



Part No	Old No	Description
8.709-702.0	337203	RainTite Switch Box
8.709-703.0	337204	Switch Box Cover

Timer

- Preset and adjustable available
- Heavy-duty



Part No	Old No	Description
9.802-472.0	6-036880	Solid State, 120V, 5-60 Min for Auto Start

Circuit Breakers

- Provides protection against excessive Amp draw



Part No	Old No	Description
9.802-485.0	6-041250	25 Amp (All 12V Systems)

Fuses

- Full range of fuses
- Protect your equipment

Part No	Old No	Code	Max V	Amps
9.802-463.0	6-022970	FNM1/2	250V	0.5
9.802-464.0	6-0229810	FNM8/10	250V	0.8
8.716-173.0	6-0229710	FNM1	250V	1.0
9.803-977.0	6-02320	FNM2-1/2	250V	2.5
8.716-187.0	6-023080	FNM3	250V	3.0
9.803-664.0	6-023090	FNM5	250V	5.0
8.716-194.0	6-02321	FNM7	250V	7.0
9.802-460.0	6-022910	FNM8	250V	8.0
8.716-165.0	6-022920	FNM10	250V	10.0



8.716-191.0	6-02311	FNQ3/10	500V	0.3
8.716-192.0	6-02312	FNQ6/10	500V	0.6
9.802-465.0	6-02306	FNQ-R-3	600V	3.0
8.716-169.0	6-02296	KTK-R1/4	600V	0.25
9.802-462.0	6-02295	KTK-R1/2	480V	0.5
8.933-007.0	6-02294	KTK-R1	240V	1.0
8.716-177.0	6-022982	KTK-R1-1/2	600V	1.5
9.803-663.0	6-02299	KTK-R2	120V	2.0
8.716-179.0	6-022990	KTK-R2-1/2	600V	2.5
8.716-180.0	6-022992	KTK-R4	600V	4.0
9.804-050.0	6-02307	KTK-R5	600V	5.0
8.716-183.0	6-02304	KTK-R30	600V	30.0

8.716-170.0	6-02297	MDL1/2	120V	0.5
8.716-175.0	6-022981	MDL3/4	250V	0.75
8.716-172.0	6-022971	MDL1	250V	1.0
8.716-174.0	6-02298	MDL2-1/2	24V	2.5
8.716-186.0	6-02308	MDL3	250V	3.0
8.716-188.0	6-02309	MDL5	250V	5.0
8.716-161.0	6-02291	MDL7-1/2	250V	7.5
8.716-163.0	6-022911	MDL8	250V	8.0



Machine Control Cam Switches – 3-Position

- Heavy-duty rotary cam switches
- Legend plate reads off/pump/burner
- Quick make/break action reduces arcing
- Wiring boot included (except 410242-3)
- Legend plate 2-1/2" square
- 4-screw mounting



Part No	Old No	Model	AMP Rating	V	Phase
8.712-219.0*	410210	S220-1686	20	110V	1Ø
8.712-224.0*	410221	S220-1687	20	220V	1Ø
8.712-225.0*	410223	S220-1688	20	220V	3Ø
8.712-227.0*	410231	S225-1686	30	110V	1Ø
8.712-228.0*	410232	S225-1687	30	220V	1Ø
8.712-229.0*	410233	S225-1688	30	220V	3Ø
8.712-234.0	410242	S432-4095	40	240V	1Ø
8.712-235.0	410243	S432-1402	40	480V	3Ø

Single-Hole Mounting – requires 1 22mm (7/8" Dia) hole

8.712-218.0	410208	220-1789	20	110V	1Ø
Replacement Knob – fits those part numbers above marked with an asterisk ()					
8.700-258.0	075052	Replacement Knob			

Cam Switch and Box – 60 AMP On/Off

Cam action fast “make-break” to reduce arcing.

- 60 Amp disconnect rating
- Four 1/2" knock-outs
- Versatile mounting
- Motor ratings:
7.5 HP @ 240vt 1Ø
5.0 HP @ 240vt 3Ø
30 HP @ 480vt 3Ø



Part No	Old No	Description
8.712-217.0	410206	63 Amp Switch w/ Large Box 4-1/2" w x 7" H x 3-3/4" D
8.712-211.0	410190	60 Amp Switch only, No Knob
8.712-212.0	410192	Box only 3-7/8" x 4-7/8" x 2-3/4" for 410190 switch using 10 gage/smaller wire
8.700-489.0	076521	Knob

NOTE: Switch does not have thermal overload protection.

Cam Switch – “Big Boot” – 3-Position

Large rectangular boot for easier wiring.

- Mounting configuration and electrical ratings same as “S” switches



Part No	Old No	Model	AMP Rating	Voltage	Phase
8.712-238.0	410260	T225-1686	30	110V	1Ø
8.712-241.0	410265	T225-1688	30	240V	3Ø
Single-Hole Mounting – requires one 22mm (7/8" Dia) hole					
8.712-223.0	410219	220-1843	20	220V	1Ø

Universal “Elektra”

UL/CSA-rated machine control cam switches.

- Position – “off” – “pump burner”
- Quick make/break action — reduces arcing
- 2- or 4-screw mount (2-1/2" square legend plate)
- (Matches: Salzer/Kraus – -imer/ Bremas & Klockner – Moeller mounts)
- “Boot” has plenty of wiring room
- Screw-to-screw/terminal-to-terminal replacement for salzer “S” and “J” type switches above
- “Tite boot” excellent dust and moisture seal
- Contacts UL/CSA-rated:
25 Amp vs 20 Amp,
35 Amp vs 30 Amp,
50 Amp vs 40 Amp



8.712-236.0



8.712-237.0



8.712-240.0

Part No	Old No	AMP Rating	Wiring Poles	Phase	Voltage	HP Rating
8.712-236.0	410251	25	1	1	120	1.5
8.712-237.0	410253	25	2	1	120/240	1.5/2.0
8.712-240.0	410263	35	2	1	120/240	2/3
8.712-242.0	410267	50	2	1	120/240	3/7.5

NOTE: None of the Elektra switches are for use on 3-phase motors without adding fuses or thermal overload.

On/Off Switch with Box - “Elektra”

UL/CSA-rated 25 and 35 Amp. Compact 3-1/4" square x 3-3/4" deep enclosure “versatile mount”.

Part No	Old No	AMP Rating	Wiring Poles	Phase	Voltage	HP Rating
8.712-214.0	410203	25A	2	1	120/240	1.5/2
8.712-216.0	410205	35	2	1	120/240	2/3

NOTE: None of the Elektra switches are for use on 3-phase motors without adding fuses or thermal overload.



ELECTRICAL COMPONENTS

Winco AC Generator

2400 Watt, 120 VT, 3600 RPM, 17 Amps.



- 15" L x 6.5" W x 6.75" H
- 59 lbs weight
- Starts and runs 1/2 HP motor
- Industrial-duty – three carbon brushes
- The standard in the pressure washing industry: Winco 2FS2MP-1
- 5/8" diameter shaft rotates either direction
- Extra slip ring for smoother power curve during motor starting
- Dual-sealed permanent bearings
- Conforms to UL1004-1, UL1004-4, and CSA 22.2 No. 100-04

Part No	Old No	Description
8.716-610.0	337440	Winco AC Generator

- Genuine Winco parts
- Save downtime — we stock below items and more!

Part No	Old No	Description	No. Req'd
Winco Repair Parts			
8.700-603.0	078451	Bearings	2
8.716-615.0	078452	Brushes	3
8.700-607.0	078455	Rectifier	1
8.700-609.0	078457	Receptacle	2
8.700-611.0	078459	Fan	1

Voltmaster Generator

2500 Watt/120V/21.6 Amp @ 3,600 RPM.



- 36.5 lbs weight
- Brushless design
- Shaft rotates either direction
- Circuit breaker protection (standard)
- 7/8" shaft, two sealed (ball) bearings
- Industrial-type watertight enclosure (11-5/8" x 7-1/2" diameter)
- All copper windings — high-surge capacity

Part No	Old No	Description
8.709-810.0	337441	2500 Watt Generator

Digital Monitor

Provides accurate testing and monitoring of electrical outlets and systems.

- Constantly monitors voltage and frequency indicated potential improper polarity and ground wiring
- Accurate testing and monitoring of all AC power sources
- RMS voltage and frequency meter
- Multi-tone fault alarm
- Hands-free auto reset
- Advanced microelectronics
- One-button operation



Part No	Description
8.749-947.0	Digital Monitor

Adjustable Thermostat

With panel-mount controls.

- 4000 PSI
- 302°F
- Accuracy ± 2.5%
- 16 Amp – 250V
- Large, easy-read dial
- Temperature change response within ± 6°F
- 3-1/2" immersion bulb w/ 60" capillary tube
- Seal, nut and 1/2" transition coupling included



Part No	Old No	Description
8.712-494.0	430050	0-194°F Thermostat
8.712-497.0	430058	0-248°F Thermostat
8.904-557.0	430060	0-302°F Thermostat
8.750-096.0		Knob 150°C/302°F

Adjustable Flow-Thru Thermostat

- Stainless-steel case
- Silver contacts
- Ceramic insulation
- Stop collar
- Tension adjusting screw
- 3000 PSI
- 10 Amps – 110V
- 5 Amps – 220V
- Adjustable 85°-195°
- 1/2" inlet, 3/8" outlet
- Fenwall inside



Part No	Old No	Description
8.904-555.0	430027	Thermostat
8.700-501.0	076731	Switch Only

Rocker Switches

- On/off switch
- Lighted available
- 125V/250V

Part No	Old No	Description	AMP	Voltage
9.802-453.0	6-020251	Curvette, V. Carling	16/10	125/250
8.716-051.0	6-020252	Curvette, 2-pos	20/15	125/250
8.716-052.0	6-020253	Curvette, 3-pos	16/10	125/250
9.802-451.0	6-020240	Carling, Green Lght, 2-pos	15/10	125/250
9.802-452.0	6-020241	Carling, Red Lght, 3-pos	15/10	125/250
8.716-037.0		Rocker	15/10	125/250



On/Off Cam Switch

- Legend plate: on/off
- Tear-drop-shaped knob
- Face plate 2-1/2" square
- Motor ratings: 410202 – 1-1/2 HP/ 110V
410204 – 6 HP/ 240V



Part No	Old No	Description
8.712-213.0	410202	20 Amp/ 110V
8.712-215.0	410204	28 Amp/ 240V

Indicator Lights

- Easily mounts to control panel
- Available in 12V, 24V, and 125V
- Great for remote applications



Part No	Old No	Voltage	Color
8.716-095.0	6-02053	125V	Red
9.802-455.0	6-020530	125V	Green
8.716-408.0	6-050413	125V	Amber
9.803-651.0	6-0399	24V	Red
9.803-652.0	6-03990	24V	Green
8.716-097.0	6-02059	12V	Red
9.802-456.0	6-020590	12V	Green

Breaker Switches



Part No.	Old. No.	Description
8.716-067.0	875971	7.5HP 230V 1PH 1400
8.716-068.0	875972	7.5HP 230V 3PH 1400
8.716-069.0	875973	7.5HP 460V 3 PH 1400
8.716-073.0	950198	10A/460V 3PH 900
8.716-074.0	950191	12A/480V 3PH
8.716-075.0	950208	15A/18.8V 3PH 800
8.716-076.0	950204	20A/277V 3PH 900
8.716-070.0	875618	25A/250V 3 PH 2255
8.716-077.0	950200	30A/277V 1PH 900
8.716-066.0	875953	40A/230V 1PH 1070
8.716-071.0	875645	DPST 20A/240V 1PH 1220

Vinyl Electrical Tape

- Premium grade – 7 mil
- UL-approved



Part No	Old No	Description
8.704-706.0	118910	Roll 3/4" x 60'

Wire Loom – For Wiring Harnesses

- Protects wires from abrasion and crushing
- Controls bundles of wires and allows for multiple exits at wiring points
- "Factory-perfect" look for all machines



Part No	Old No	Description
8.709-679.0	337120	1/4" ID 100' Roll
8.709-680.0	337121	3/8" ID 100' Roll
8.709-681.0	337122	1/2" ID 100' Roll
8.709-682.0	337123	5/8" ID 100' Roll

GFCI Module 20 Amp – 120V or 240V

Not recommended for field service.

- Using 120V or 240V shop attachable module; attach your power cord length as required
- Use with 16-12 gauge SJ, SJO or SJT 3-wire cords
- 20 Amp rating at 120V or 240V 60 Hz



Part No	Old No	Description
8.709-858.0	337642	GFCI Module 1PH
8.709-859.0	337643	GFCI Module 3PH (not pictured)

Cord Caps/Plugs



8.709-653.0 8.709-655.0 8.709-656.0 8.709-659.0

- Industrial-quality
- Dead front cord caps — nylon body straight plugs and "auto-clamp" for cord
- 337013 angle plug has vinyl body and both 30A and 50A neutral leg

Part No	Old No	Description
8.709-653.0	337000	15A/120V, Black Nylon
8.709-655.0	337004	20A/120V, Black Nylon
8.709-656.0	337006	20A/250V, Black Nylon
8.709-659.0	337013	30A-50A/250V, Black Vinyl

Romex Connectors (Metal)



Part No	Old No	Description
8.709-663.0	337020	1/2" Strt. Connector
8.709-664.0	337021	3/4" Strt. Connector
8.709-660.0	337017	1/2" Lock Nut Only
8.709-661.0	337018	3/4" Lock Nut Only

ELECTRICAL COMPONENTS

Liquid-Tight Strain Relief Connector for Cable, Wire and Tubing

Keep water-tight NEMA-4 and 4x enclosures water-tight with these unique fittings.

DOME NUT WITH INSIDE TAPER. As the dome nut is tightened, the seal ring grips, holding the cable wire or tubing positively in place.

LEAD-SCREW THREAD. The dome nut can be firmly tightened due to the high strength lead-screw thread.

Part No	Type	Thread	Cord Size	Cord OD	Length
8.709-687.0	Dome	1/2" NPT	14/3-12/3	.230"-.470"	1.8"
8.709-688.0	Dome	3/4" NPT	14/3-12/3	.350"-.630"	2.0"
8.709-689.0	Dome	3/4" NPT	12/3-10/4	.510"-.710"	2.0"



PLASTIC JAM NUTS

Part No	Thread
9.802-525.0	1/2" NPT
9.802-526.0	3/4" NPT

CLAMPING SPLINES. Various sizes and odd-shaped cables, wires and tubing can be accommodated due to overlapping diagonally split clamping splines.

Part No	Type	Thread	Cord Size	Cord OD	Length
8.709-690.0	Flex	1/2" NPT	14/3-12/3	.230"-.470"	4.3"
8.709-692.0	Flex	3/4" NPT	12/3-10/4	.51"-.71"	5.2"



CONDUIT

Part No	Description
9.802-448.0	Watertight Flex 1/2" x 100' Box

Ground Fault Circuit Interrupters (GFCI)

GFCIs protect people and equipment by interrupting potentially lethal ground circuits exceeding 6mA. The dangers of electrical shocks have been long known — GFCIs are the only real way to be safe. Most city and county codes now require GFCI protection on power cleaning equipment.

- UL-listed
- Three wire circuits
- Transient voltage protection
- 4-6mA ground fault protection
- Grounded neutral protection
- Mechanical trip indicator
- Compact size
- Rugged construction
- Radio frequency interference suppression

Part No	Old No	Volt	Amp	Length	Plug Included
8.709-850.0	337626	120V	15A	12'	Yes
9.802-432.0		120V	15A	36'	Yes
8.709-842.0	337607	120V	20A	12'	No
8.903-807.0	337608	120V	20A	12'	Yes
8.709-843.0	337609	120V	20A	35'	Yes
9.802-431.0		120V	20A	36'	Yes
9.802-433.0	6-010631	240V	20A	36'	Yes
9.802-434.0		240V	40A	36'	Yes
8.709-860.0	337645	240V	30A	6'	No
8.709-853.0	337632	240V	30A	6'	Yes
8.709-861.0	337647	240V	30A	12'	No
8.709-854.0	337634	240V	30A	12'	Yes
8.709-862.0	337649	240V	30A	35'	No
8.709-855.0	337635	240V	30A	35'	Yes
9.802-430.0		240V	30A	36'	Yes
GFCI Plug without Cord					
8.709-847.0	337615	120V	15A	N/A	Yes
8.709-846.0	337614	120V	20A	N/A	Yes

NOTE: User-attached plug also includes the sealant necessary to attach the power cord per UL specification.



Molded Plastic Float Tanks

- Molded polypropylene
- 7-liter size: 13" x 5" x 6"
- 1-gallon size: 10" x 5" x 8"
- No holes for max flexibility
- 1-gallon tank has tight-fitting lid, included
- 7-liter tank lid is snap-on and sold separately



Part No	Old No	Description
8.710-026.0	343002	7-Liter Tank Only
8.710-027.0	343003	7-Liter Tank Lid
8.710-028.0	343004P	1-Gallon Tank w/ Lid

Stainless-Steel Float Tank

- Fully welded and water tight
- 2.8-gallon capacity
- 12" x 9" x 6"
- 16 gauge #303 stainless-steel
- 1/2" full coupling (stainless-steel) inlet/outlet
- Convenient mounting tabs



Part No	Old No	Description
8.710-029.0	343006	Stainless-Steel Float Tank
8.710-034.0	343016	Stainless-Steel Lid

Frames, Direct Drive & Belt Drive

- Heavy-duty aluminium that is more corrosion-resistant than steel
- 10" flat-free-tires for better reliability
- Integrated nozzle holders
- Available in both direct and belt-drive models



Part No	Description
8.924-399.0	Aluminium Frame, DD CW
8.924-400.0	Aluminium Frame, 270 & 390 AL DD CW
8.924-402.0	Aluminium Frame, BD CW
8.924-401.0	Aluminium Frame, BD CW 200

Replacement Fuel Cap

- Fits 9-Gallon Diesel Fuel Tank (8.710-142.0)
- Fits Fuel Tanks (8.751-294.0, 8.751-296.0, 8.751-293.0)

Part No	Description
8.751-449.0	Replacement Fuel Cap for Fuel Tanks

Fuel Tank - 9-Gallon Diesel

- Strap or bolt mount (4/5/16" inserts in bottom)
- Metal inset 3/8" inlet/return lines
- Black – crosslinked PE
- Vented fuel cap
- Filler neck doesn't extend beyond tank wall
- Compact size: 19-3/4" L x 12" W x 10-1/2" H



Part No	Old No	Description
8.710-142.0	344735	9-Gallon Fuel Tank – Plastic

NOTE: Includes fuel cap.

Fuel Tanks



8.751-293.0



8.751-294.0

- EPA/CARB-compliant
- Seamless one-piece construction of marine grade, UV-protected polyethylene
- Built-in reserve (when gauge reads "empty", tilt to access additional fuel)
- Two-stage click when closed fuel cap
- 90° fuel withdrawal fitting
- Easy-to-read sight gauge
- Four shapes and capacities from which to choose

Part No	Gallons	Length	Width	Height
8.751-294.0	6	21.18"	13.5"	10"
8.751-296.0	12	20.375"	13.75"	14.75"
8.751-293.0	12	24.25"	18"	11"

Rubber Parts



9.802-064.0



9.802-066.0



8.706-557.0



9.802-067.0



9.802-069.0

Part No.	Old No	Description
9.802-064.0	859815	Grommet, Nozzle Holder
8.706-557.0	616018	Bellows, Leg Boot
9.802-067.0	830587	Bumper Pad, Engine
9.802-069.0	691877	Handle Grip
8.706-745.0	829620	Plug, Hole Plastic
9.803-046.0	784446	Mount, Rubber Vibration
8.706-525.0	891040	Mount, Rubber Vibration 203/8-25 std
8.706-553.0	891041	Mount, Rubber Vibration 60 duro
8.706-524.0	891048	Mount, Rubber Vibration 1-3/8" dia x 3/4"
8.706-556.0	891051	Mount Vibration
9.802-066.0		Pad, Soft Rubber

CHASSIS COMPONENTS

Fuel Caps

- For gas or diesel fuel tanks
- Fits standard 2-1/4" fuel necks



Part No	Old No	Description
8.710-137.0	344725	Fuel Cap
8.701-700.0	091520	Fuel Cap with Gauge 10"

Battery Boxes with Cover, Marine Style

Protect batteries on pressure washers, boats or other industrial equipment.

- Attractive molded polypropylene
- Complete with hold-down cleats and strap for cover
- Small: 8-1/2" L x 6" W x 8-1/2" H
- Large: 11-1/4" L x 7-3/4" W x 10-3/4" H



Part No	Old No	Description
9.802-090.0	306625	Small Box
9.802-075.0	306627	Large Box

Flat-Free Tires

Flat-Free Tires provide the bounce and load handling characteristics similar to an air filled tire - with the benefit of never going flat. Flat-Free tires are lightweight, non-marking, and come mounted on a heavy-duty steel rim with shielded ball bearings. Not for highway use.

- Heavy-duty Steel Rim
- Non-Marking
- 4" Steel Rim: Max load 300 lbs
- 12" Steel Rim: Max load 375 lbs



Part No	Description
8.711-898.0	Wheel & Tire Assembly, 4" Steel Rim
8.754-435.0	Wheel & PU Tire Assembly, 12" Steel Rim

Plastic Dip Tube Assembly



- New style plastic dip tubes
- Rubber bushing seal ordered separately

Part No	Description
8.706-494.0	Plastic Dip Tube Assembly, 7.5" Long
8.706-495.0	Plastic Dip Tube Assembly, 12" Long
8.706-496.0	Plastic Dip Tube Assembly, 17.75" Long
9.802-053.0	Rubber Bushing, Fuel Line

Complete Wheels



8.711-901.0

9.802-270.0

9.802-271.0

- High-quality pneumatic, and semi pneumatic
- Fits 5/8" shaft



8.712-762.0

Part No	Old No	Description
8.711-901.0	4-0304	10" Mag
9.802-270.0	4-0303	10" Steel Rim w/ Tube
8.754-435.0	4-0307	13" Steel Rim
8.712-762.0	480115	10" White steel rim, 3/4" Hub Tubeless
8.711-905.0	4-03071	6" Steel Rim Foam Filled
8.711-921.0		6" Tube Only
8.712-767.0		10" Tube Only
9.802-274.0		10" x 2-3/4" Hard Rubber Wheel
8.711-908.0		3" Gray Caster Wheel



Interchangeable Bearings

Part No	Old No	Description
8.700-484.0	076504	5/8" Bore Bearing
8.700-486.0	076505	3/4" Bore Bearing
8.700-485.0	076504P	5/8" Nylon Bearing

Hub Caps and Collars

Part No	Old No	Description
8.700-183.0	071625	3/4" Hub cap
8.700-184.0	071627	5/8" Hub cap
9.802-782.0		5/8" Bore Shaft Collar

Miscellaneous Parts

Part No	Description
8.719-064.0	Chassis Knob 5/16" Thread, Black
9.802-066.0	Soft Rubber Foot Pad
8.932-992.0	Vibration Isolator 3/8"

A+ Surface Cleaner



Fast, even cleaning for large flat surfaces. Quickly cleans concrete & asphalt, and removes grime and deposits from tennis courts, ramps, and decks. Also great for factory floors, semi-trailer floors & drive-throughs. Cleans better and faster than spray wand alone, with no striping. Use with hot or cold water. Handles water up to 212° F to disinfect bathrooms and kitchens. Safety lock prevents accidental spraying.

- Two spinning nozzles 'floats' cleaner above the ground
- Circular design allows a zero wall clearance
- Stainless steel housing and handle
- Comfort Grip trigger handle
- 3/8" male quick connector plugs into your pressure washer's hose
- Reduces overspray on walls, landscaping, and operator
- Comes with two #2.0, 1/8" nozzles (for machines up to #4.0 nozzles), 25° nozzles rated up to 8 GPM & 4000 PSI
- Requires at least 3 GPM & 2000 PSI



Part No	Description
8.753-572.0	A+SC21 Rotary Surface Cleaner, 21"
8.753-573.0	A+SC24 Rotary Surface Cleaner, 24"
8.753-597.0	Swivel for 21" and 24"

Whisper Wash Flat Surface Cleaners

- Saves labor, fuel and water
- Balanced spray bar
- Eliminates overspray and zebra striping
- Quick connection
- Use with conventional pressure washers
- 2,000-4,000 PSI
- Use with cold or hot waterR
- 2500 RPM

Applications:

- Service stations
- Public facilities
- Driveways
- Pool and patio decks
- Restaurants
- Sidewalks
- Warehouse floors
- Gondolas
- School yards
- Loading docks
- Stadiums
- And lots more!!
- Parking lots
- Marina docks

The "Maxima 36"

- Portable breakaway handle
- 212°F
- 4-10 GPM
- 2500 RPM
- Dimensions: Cover: 36", Handle: 77"
- Weight 37 lbs
- Uses 1/4" nozzle



Part No	Original No.	Description
8.710-089.0	343636	Maxima 36

Whisper Wash Flat Surface Cleaners – continued

Ground Force

- Flip and fold handle
- Choice of two or four nozzles
- Rebuildable swivel
- 212°F
- 4-10 GPM
- Dimensions: 24" x 60" x 9"
- Weight: 29 lbs
- Uses 1/4" nozzle



Part No	Old No.	Description
8.710-076.0	343608	Ground Force

The "Big Guy"

- Powder-coated aluminum housing
- Oversized, self-lubricating twin thrust bearings
- Choice of two or four nozzles
- 10" pneumatic tires, 4" caster
- Crafted with durable stainless-steel and aircraft aluminum
- 212°F
- 4-10 GPM
- Dimensions: 28" x 44" x 12"
- Weight: 48 lbs
- Uses 1/4" nozzle



Part No	Old No.	Description
8.710-074.0	343606	Whisper Wash Big Guy Two Nozzles
8.710-075.0	343607	Whisper Wash Big Guy Four Nozzles
8.750-604.0	092110	Swivel, Complete Big Guy and Classic
8.701-879.0	092105	Repair Kit, Seal, Big Guy and Classic
8.701-874.0	092101	Spraybar, 4 Nozzle, Big Guy
8.701-876.0	092102	Spraybar, 2 Nozzle, Big Guy

The Classic

- Portable breakaway handle
- ABS Housing
- 2" nylon brush
- 212°F
- 4-10 GPM
- Dimensions: 19" x 77" x 12"
- Weight: 28 lbs
- Uses 1/4" nozzle



Part No	Original No.	Description
8.710-073.0	343605	Whisper Wash Classic
8.750-604.0	092110	Swivel, Complete Big Guy and Classic
8.701-879.0	092105	Repair Kit, Seal, Big Guy and Classic

PRESSURE WASHER ACCESSORIES

Whisper Wash Flat Surface Cleaners – continued

The Ultra Clean WW

- ABS Housing
- Four 3" casters
- Powder-coated handle
- Dimensions: 19" x 43" x 9"
- 185°F
- 3-6 GPM
- 2500 RPM
- Weight: 23 lbs
- Uses 1/4" nozzles



Part No	Original No.	Description
8.710-072.0	343604	Whisper Wash Ultra Clean WW

The Ultra Clean HC

- ABS Housing
- 2" nylon brush
- Powder-coated handle
- Dimensions: 16" x 43" x 9"
- 185°F
- 3-6 GPM
- Weight: 19 lbs
- Uses 1/4" nozzles



Part No	Original No.	Description
8.710-071.0	343603	Whisper Wash Ultra Clean HC

Repair Kits

Part No	Original No.	Description
8.701-879.0	092105	Seal Kit; Classic, Big Guy and Ground Force
8.701-882.0	092108	Seal Kit; Ultra Clean
8.701-883.0	092109	Complete Swivel Kit; Ultra Clean
8.750-604.0	092110	Complete Swivel Kit; New Style
		Classic, Big Guy and Ground Force
8.707-653.0	251119	2.5 x 25° 1/4" Nozzle Fits All Models

Mosmatic Gun Swivel



Mounts to your high-pressure gun or lance for an easy turning, low-maintenance gun swivel

- 4000 PSI
- 250°F
- 30 RPM



Part No	Original No.	Description
8.712-467.0	421057	1/4" MPT / 1/4" FPT Gun Swivel
8.712-466.0	421056	3/8" MPT / 3/8" FPT Gun Swivel

Mosmatic Surface Cleaners and Duct Cleaner



Turbo Surface Cleaner

Delivers high-pressure performance with low Maintenance for any hot or cold pressure washer. Completely stainless-steel design makes this the toughest surface cleaner available in the pressure-cleaning market.

Swiss-engineered with high RPM swivel features reinforced self-lubricated stainless-steel ball bearings and dual spring-based carbide seal bushings for long-lasting operation under tough conditions.

- 4000 PSI
- 250°F
- 6.5 lbs



Ideal for pressure washer contractor to clean walls, ceilings, public facilities, tile floors and other hard-to-reach areas. Uses 1/8" meg 1503 nozzles.

- 4000 PSI
- 250°F
- 2 lbs
- Inlet Ports 3/8" NPTF

Duct Cleaner

Designed as an accessory for use with high-pressure pumps or pressure washers. Cleans ducts, chutes, vents, restaurant exhausts, tanks, etc.

- 4000 PSI
- 250°F
- 9 lbs
- 12" stainless-steel

Self-rotating and feeding stainless-steel triple bearing system for constant easy turning. Nozzle holders are 1/8" NPTF. Nozzles are sold separately.



12" Surface Cleaner

Designed for effortless cleaning of small areas, including walls and angled surfaces. High RPM swivel with integrated toggle joint and adjustable tension system.

Part No	Original No.	Description	PSI
8.712-284.0	411171A	Turbo Cleaner – 8"	4000
8.712-285.0	411172	Toggle Joint KGK	4000
8.712-280.0	411156	Duct Cleaner TXR-2s, Adjustable	4000
8.712-279.0	411155	Duct Cleaner TXR-2s, Fixed	4000
8.749-911.0		Surface Cleaner – 12"	4000

Surface Cleaner Nozzle Recommendation

Determine the correct nozzle size for the pressure washer being used with the surface cleaner. Never use a smaller size nozzle as this will prematurely wear out the unloader valve on the pressure washer. The Legacy Undercarriage Cleaner and A+ Surface Cleaners come supplied with nozzles, for other surface cleaners, nozzles must be purchased separately. Threaded nozzles are listed on pages 80-81 of the catalog, to determine your pressure washer nozzle size refer to chart on page 78. Contact your RSM on other sizes or surface cleaner spray bars that use 4 nozzles or other sizes.

Pressure Washer Nozzle Size		15° x 1/4" MPT	25° x 1/4" MPT
# 3.5 and # 4.0	2 each	#2.0	#2.0
#4.5 and # 5.0	2 each	#2.5	#2.5
# 5.5 and # 6.0	2 each	#3.0	#3.0
# 6.5 and # 7.0	2 each	#3.5	#3.5
# 7.5 and # 8.0	2 each	#4.0	#4.0

Mosmatic Roof Cleaner

Industrial-quality tool specially designed for efficient, high-pressure roof cleaning while keeping the operator in a safe area.

- 21"
- 4000 PSI
- 250°F
- 31.9 lbs.
- Pressure gauge
- Ball valve
- Adjustable wheels (height and width)
- Safety eye connection for rope or cable
- Two 1/8" nozzles sold separately



Part No	Description
8.749-910.0	Mosmatic Roof Cleaner

"Cyclone" Rotary Flat Surface Cleaner



- 4 - 6 GPM
- 2000 - 4000 PSI
- 200°F
- Polyethylene housing
- Collapsible handle
- Pneumatic tires
- 20" diameter surface cleaning
- Up to 5 gpm
- Weight: 35 lbs

Part No.	Original No.	Description
8.710-073.0		Classic Rotary Surface Cleaners (yellow)
8.710-074.0	630853	"Big Guy" Rotary Surface Cleaners
8.903-608.0	30-587	"Cyclone" Surface Cleaners

Undercarriage Cleaner

Legacy

- No more crawling under a vehicle
- Simply connect to your hot or cold water pressure washer
- Easy to handle and maneuver
- Removes road grime, fuel and oil contaminants
- Removes snow sludge and ice
- Provides a clean, working environment for technicians
- Stainless-steel rotating assembly built to withstand pressures up to 4000 PSI and 250°F
- 5.5" required clearance
- Four Nozzles: (2) 0° #2.0, (2) 25° #2.0



Part No	Description
8.749-303.0	Undercarriage Cleaner

Oil-Fired Hot Box

Legacy

Add hot water cleaning economically! Portable water heater add-on for existing cold water pressure washers. Quick Connect to cold water washer, supply fuel and power to Euro-Heat for hot water cleaning applications — USE ONLY WHEN NEEDED and keep the convenience of the portable cold water washer.

- 3000 PSI
- Quick hookup — 3/8" QC inlet / outlet
- Easy service access to burner parts
- Efficient vertical combustion configuration
- Diesel, kerosene, #1 heating oil
- 10" easy-roll tubed pneumatic wheels
- 5-gallon plastic fuel tank
- Compact size — 37" W x 27" L x 39" H
- 36' Ground Fault Interrupter plug
- Thermostat temperature control



Part No	Original No.	Description
1.103-910.0	HR-5030D	5 GPM / 3000 PSI – 120V

PRESSURE WASHER ACCESSORIES

Goff's Curtain Walls

Build a Power Wash Cell to meet your needs. Goff's Curtain Walls™ increase useable floor space while controlling overspray, contaminants, climate, and noise levels. Curtain Walls™ glide easily on steel track and dual-wheeled rollerhooks. Made from a combination of 14-oz., heavy-duty, reinforced vinyl and double-polished 20-mil clear PVC material. Reinforced hems and chain-weighted lower hems add durability. Hook and loop fasteners on side hems attach to adjacent panels. Meet NFPA-701 requirements for flame retardancy. Curtains are also rot and mildew resistant. Standard model has a white vinyl top, clear PVC center, and blue vinyl bottom.

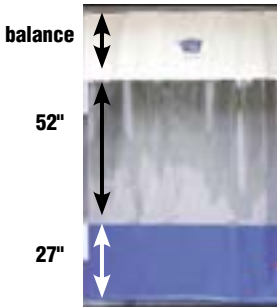
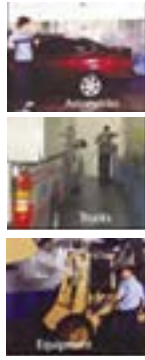

- #2 Brass tooth grommets on 1' centers
- 14 oz. reinforced vinyl white top section
- All seams double-locked stitched
- Hook and Loop Fasteners allow adjacent panels to be easily attached to one another
- 20 mil. double-polished clear window
- All sections joined together using mildew/rot resistant thread
- 14 oz. reinforced colored vinyl section (your choice of over 12 different colors)
- Chain-weighted lower hem

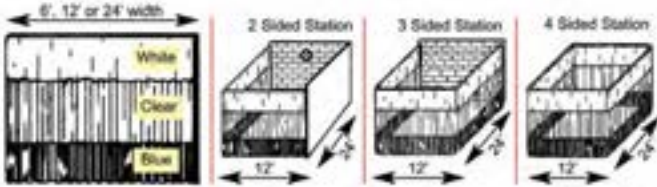

Part No	Original No.	Description	PSI
Single			
9.841-694.0	681133	6' width x 12' high	1500
8.717-007.0	681083	12' width x 8' high	1500
8.717-008.0	681084	12' width x 9' high	1500
8.717-009.0	681086	24' width x 10' high	1500
8.739-486.0	681087	24' width x 12' high	1500
Station			
9.841-695.0	681145	4-sided x 12' high	1500

Includes hardware, track and rollers (white top, clear center and blue bottom panel)
All 2-, 3- and 4-sided stations are 12' wide x 24' long (see diagram above).

Other sizes available — call for details

Sandblast Kit – Carbide Nozzle Industrial Grade



A Venturi orifice creates a uniform blast pattern, doubles sand velocity and produces up to 45% more work with 20% less sand.

- 5500 PSI max working pressure
- 10 GPM max flow
- 200°F
- 10 lbs.
- Nozzle tips sold separately



Part No	Original No.	Description
8.701-485.0	084079	Sand Blast Kit DWSDBTK

Self Serve Underbody Wand Assembly



Ideal for rinsing the undercarriage of cars and trucks. Connect directly to a pressure washer gun or lance. Lightweight, the underbody wand assembly rolls easily giving the operator a long reach.

- Ergonomic lance to reduce bending
- Stainless Steel
- Uses 3 threaded MEG Nozzles
- 3000 PSI
- 300° F
- Inlet 1/4"
- Non-weeping



Part No	Description
8.755-257.0	Self Serve Underbody Wand Assembly

Sandblast Nozzles Tips

- Replacement tips for Sandblaster Kit (part no. 8.701-485.0 – Original no. 084079)
- Use 1/4" meg 5' spray tip



Part No	Original No.	Description
8.707-668.0	251159	4.0 x 5° Tip
8.707-685.0	251198	5.0 x 5° Tip
8.707-696.0	251221	5.5 x 5° Tip
8.707-701.0	251237	6.0 x 5° Tip
8.707-709.0	251256	6.5 x 5° Tip

Professional Sandblast Head

- Long-wearing Carbide sand nozzle
- 1/4" FPT water inlet
- 200°F
- 10 GPM
- 3500 PSI
- Sand probe weight 6 oz, length 16"
- Head weight: 13 oz



Nozzle Size	Part No	Original No.
3.5	8.711-242.0	391631
4.0	8.711-243.0	391632
4.5	8.711-244.0	391633
5.0	8.904-403.0	391634
5.5	8.711-245.0	391635
6.0	8.904-404.0	391636

Part No	Original No.	Description
8.711-247.0	391640	Sand Probe
8.901-264.0	121041	1/2" ID Polybraided Tubing, 25'



Sewer/Tube Cleaning Nozzles

The reverse jets on the fixed and rotary nozzles pull the hose through the tube or sewer line and blast debris from line or tube walls.

- 4200 PSI
- Physically small for cornering ability
- Corrosion-resistant stainless-steel construction
- Orifice size indicated on non-rotating styles
- Backward ports drive the nozzle forward and flush debris
- Forward ports blast into pipe and breaks up clogs and debris
- Rotating style adds extra agitation and surface cleaning

Part No	Old No	Nozzle	Orifice Size	O.D.	Ports
Non-Rotating Sewer Nozzles					
8.710-875.0	373024	1/8"	4.5	.580"	0-forward, 3 back
8.710-874.0	373023	1/8"	5.5	.580"	1-forward, 3 back
8.710-878.0	373027	1/4"	4.5	.730"	1-forward, 3 back
8.710-876.0	373025	1/4"	5.5	.730"	1-forward, 3 back
8.710-877.0	373026	1/4"	6.0	.730"	1-forward, 4 back
8.710-880.0	373029	1/4"	7.5	.730"	1-forward, 4 back
8.710-879.0	373028	1/4"	8.0	.730"	1-forward, 3 back
8.710-881.0	373032	1/4"	12	.730"	1-forward, 3 back
8.710-885.0	373038	3/8"	4.0	.920"	1-forward, 3 back
8.710-884.0	373037	3/8"	5.5	.920"	1-forward, 3 back
8.710-886.0	373039	3/8"	8.5	.920"	1-forward, 4 back
8.710-883.0	373036	3/8"	12	.920"	1-forward, 4 back
8.710-882.0	373035	3/8"	14	.920"	1-forward, 4 back

Part No	Old No	Rotating Nozzle Size	Ports
Rotating Sewer Nozzles			
8.710-899.0	373062	1/8"	5.5 0-forward, 3 back
8.710-898.0	373061	1/4"	5.5 0-forward, 3 back
8.710-900.0	373064	1/4"	8.0 0-forward, 3 back
8.710-887.0	373040	1/4" Duct Clnr*	5.5 0-forward, 2 side

*Duct Cleaner jet to sides instead of reverse

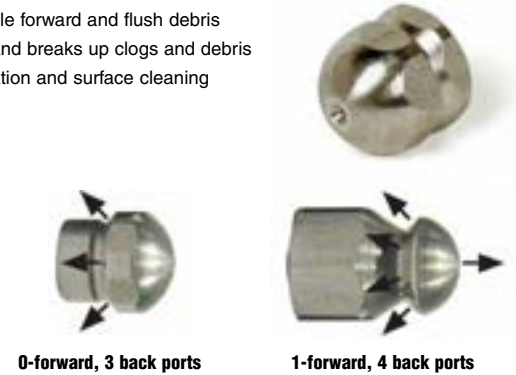

- Rotating sewer nozzle
- Adds extra agitation
- 4000 PSI
- Back Jet Only

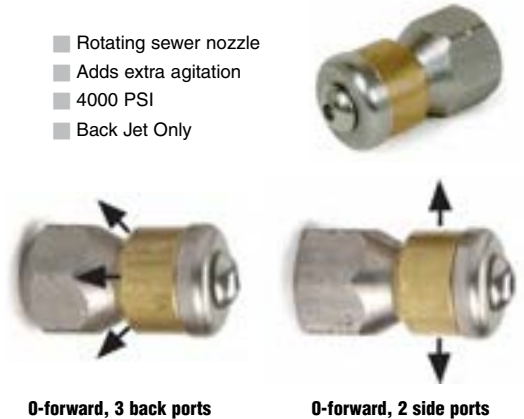

Stainless-Steel Sewer Nozzles

- 4100 PSI
- Corrosion-resistant stainless-steel
- One forward orifice
- Three rear orifices



Part No	Original No.	FPT	Size
8.710-905.0	373075	1/8"	5.0
8.710-906.0	373076	1/8"	5.5
8.710-907.0	373077	1/8"	6.0
8.710-908.0	373078	1/4"	6.5
8.710-909.0	373079	1/4"	7.0
8.710-910.0	373080	1/4"	9.5

Water Broom 16"



- 4000 PSI
- Fits any 1/4" wand
- Requires (4) 1/4" nozzles and wand

Part No	Original No.	Description
8.710-082.0	343615	Water Broom 16"

Mat Clamp

- Hang floor mats, scrubber pads, rugs, rags, coveralls, etc., for close-up pressure washing and drying



Part No.	Old No	Description
8.709-071.0	823885	Aluminum Spring Action

PRESSURE WASHER ACCESSORIES

Dual-Chemical Systems

- New deep-ribbed yellow casing, stays flexible even in cold temperature
- Hose assembly complete with gun and amphenol connectors pre-wired
- Fully-compatible with Power Blaster, Two-Step, Chemex and most other cold water dual-chemical systems



Part No	Original No.	Description
Complete Hose Assembly		
8.709-044.0	285116	80' R2 Electric (5 wire)
8.709-045.0	285120	100' R2 Electric (5 wire)
Lance Attachment Parts		
8.709-049.0	285136	Female Receiver
8.709-050.0	285137	Male Lance Swivel
8.709-051.0	285138	Retainer Nut
Complete Remote Gun Unit		
8.709-046.0	285125	Gun, Electric
Remote Gun / Hose Parts		
8.709-048.0	285135	Gun Housing
8.709-053.0	285139	Switch P/B
8.709-054.0	285140	Switch, Chemical
8.709-056.0	285142	Switch Plate
8.903-083.0	285144	O-ring, Nipple (Two req'd)
8.903-084.0	285145	O-ring, Nipple (Bags of 50)
8.709-060.0	285175	Swivel Adapter
8.709-061.0	285177	Cord Grip
8.709-063.0	285181	Oetiker clamp
8.709-064.0	285187	Switch - Push Button Trigger
8.709-065.0	285189	Toggle, DPDT (Trig) On/Off/On

Sewer Hose

SUPER FLEXIBLE SEWER LINE HOSE

Hose and couplings have small outside diameter, allowing hose and nozzles to fit through sewer line. Sewer line has Super Tough poly-ether cover over ultra-flexible nylon tube. (1/8" sewer nozzle and hose will operate through many 1-1/2" lines.)



- 160°F
- Nylon tube, poly-ether cover

(Nozzles not included.)

Part No	Original No.	Description
1/8" hose - 4800 PSI, 1/4" inlet / 1/8" outlet		
8.705-601.0	150960	1/8" x 25'
8.705-602.0	150963	1/8" x 50'
8.705-603.0	150964	1/8" x 100'
1/4" Hose - 2600 PSI, 1/4" inlet / 1/4" outlet		
8.705-607.0	150968	1/4" x 50'
8.705-608.0	150970	1/4" x 100'
1/4" Hose - 4400 PSI, 1/4" inlet / 1/4" outlet		
8.705-610.0	150972	1/4" x 50'
8.705-611.0	150973	1/4" x 100'
8.705-613.0	150975	1/4" x 200'

Foot-Controlled Pressure Valve

Operators of sewer and tube cleaning equipment need both hands free to feed or retract the hose in the sewer line. Foot-operated valve allows hands-free control.



- Inlet 3/8" - outlet 1/4"
- Brass body - stainless-steel valve
- Steel cover for safety
- Up to 12 GPM
- Up to 5000 PSI

Part No	Original No.	Description	PSI
8.710-134.0	344200	Sewer Cleaner Foot Valve	3000
8.709-972.0	342024*	Foot Valve w/ ST-2305	5000
8.701-657.0	089006	Repair Kit - Foot valve	
8.701-673.0	089850	Repair Kit ST-2305	
8.711-526.0	4-0193	Kit, 25' Hose, #4.5 Nozzle, Foot Valve	

*Heavy gauge steel construction for durability and stability

ST-36 Pit Boss Sludge Sucker

Sludge Sucker uses a high-pressure water stream (1000-3000 PSI) to suck the sludge off the bottom of pits or tanks and eject it through a 1-1/2" (15' long) hose to a disposal tank.

The base unit attaches to the end of a pressure washer lance with a quick coupler for extension to the bottom of the pit. Uses a 0° tip for suction / power ejection.



- Uses standard 1/4" MPT nozzle
- Easy to change for different plumbing system flows and pressures

Part No	Original No.	Description
8.711-112.0	376137	ST-35 Pit Boss, 5.5 Nozzle / 15' Hose
8.711-110.0	376126	(Base unit only)

*w/o hose, nozzle or quick coupler (3/8" inlet port)

Drum Pumps

Siphon liquids from higher to lower levels. Simply pump the bellows a few times to prime and start flow. Loosen air lock to stop.

- Drum pump fits 15-, 30- and 55-gallon drums
- Fit 2" bung opening
- Excellent for alkaline and acidic chemicals, diesel fuel, and oils
- Not for use with solvents!



Part No	Original No.	Description
8.704-698.0	118429	Red Hex Head (Heavy-duty)
8.704-696.0	118423	Red Head (Standard duty)
8.704-694.0	118420	Pail Pump (5 Gallon)

Fiberglass “Super Handles”



- Tough, durable, lightweight
- No cracking, splintering
- No kinks, dents
- Safer around electrical hazards
- Easy-twist cam lock extension
- Super heavy-duty aluminum alloy threads
- Standard 3/4" Acme thread fits: brooms, brushes, utility tools
- Optional reduction adapter for 3/4" to Acme standard

Part No	Original No.	Description
Super Handles		
8.709-306.0	306864	48" Length (4 ft.)
8.709-307.0	306865	60" Length (5 ft.)
8.709-308.0	306866	72" Length (6 ft.)
Super-Extension Handles		
8.709-309.0	306868	4 ft. to 8 ft. Ext.
8.709-310.0	306869	6 ft. to 12 ft. Ext.
8.709-311.0	306870	8 ft. to 16 ft. Ext.
8.700-308.0	075271	Threaded Adapter

Drum / Tank Pump – Crank Type

Chemical-resistant, lightweight pump, ideal for dispensing chemicals, pesticides and oils. Polypropylene for most alkalies, dilute acids, pesticides, and most oils and solvents. Ryton for extremely aggressive acids, aromatic and aliphatic hydrocarbons.

- 11 oz per revolution
- 6 GPM @ 70 RPM
- Viton seals
- Polypropylene gasket
- Outlet 3/4" barb two-piece
- 2" bung adapter
- 47" suction tube
- Weight: 2.6 lbs



Part No	Original No.	Description
8.704-700.0	118435	Polypropylene Pump (Standard)
8.704-701.0	118438	Ryton Pump (Deluxe)
8.700-526.0	076975	Replacement Handles

Drum Tool Accessories

The indispensable tools.

Part No	Orig. No.	Description
8.712-534.0	449339	Drum Plug Wrench
8.704-689.0	118400	Lid-Off
8.704-691.0	118404	Funnel, 7" x 10"
8.704-692.0	118407	3/4" Faucet
8.704-693.0	118408	2" Faucet
Load Cincher Tie Downs		
8.707-473.0	249938	7/8" x 5-1/2' (Non-Ratchet) "Quick Lock"
8.707-474.0	249939	1" x 15' (Ratchet) "Tight Lock"

Brushes



Rotating Brush – Natural Bristle (soft) used for painted surfaces. Nylon Bristle (stiff) used for removing scum and grime on fiberglass boats, etc.

- Internal nozzle = size 20
- 8 GPM

Part No	Original No.	Description
Brush Unit Complete		
8.709-312.0	306925	Natural
8.709-314.0	306935	Nylon
Replacement Brushes		
8.709-313.0	306927	Natural
8.709-316.0	306937	Nylon



Truck Wash Brush

- Flag-tipped
- Soft bristle
- ACME thread for Super Handles, or broom handles



Part No	Original No.	Description
8.709-298.0	306800	2-1/2" Bristle w/ Bumper x 10"
8.709-303.0	306818	2-1/2" Bristle x 18"
8.709-304.0	306824	2-1/2" Bristle x 24"
8.709-305.0	306860	60" Flow Thru Lance*

*with Acme Thread and Garden Hose Attachment

Deck Scrub Brush – Over / Under

- Not a Flow Thru
- Excellent chemical resistance
- Use with threaded handle
- Trimmed for cleaning hard-to-reach areas
- Stiff polypropylene bristle for aggressive cleaning
- Unique heavy-duty scrub brush with multi-level / angle.
- 10" molded polypropylene foam block does not warp or absorb water



Part No	Original No.	Description
8.709-302.0	306812	Deck Scrub Brush

Tractor Brush – Soft for gentle cleaning of fine finishes.

Part No	Original No.	Description
8.709-298.0	306802	Flag Tip Window 10"



PRESSURE WASHER ACCESSORIES

Compact Foamer

Legacy

Generates a high-density clinging foam for extended dwell-time to increase chemical action.

- Stainless-steel, aluminum and brass
- 5" long, 1" diameter
- 4 and 6.5 nozzle included
- 1 to 5 GPM
- 195°F
- 2500 PSI



Part No	Original No.	Description
8.903-998.0	344022V	1/8" F Inlet
8.903-999.0	344023V	1/4" F Inlet

NOTE: Most cleaning chemicals perform best when applied at 120°-150°F and can be applied as a foam by adding a foaming agent. See your chemical supplier to obtain the correct product.

Foam Cannon

The ideal Foam Generator Application Accessory meters the foaming chemical for customized foam type and applies the foam to match the application.

- Brass meter valve
- 3000 PSI max pressure
- High-impact, glass-filled body
- 4.8 GPM max flow
- Stainless-Steel Foam Turbulator
- 176°F max temperature
- 1/4" FPT lance connect
- Stainless-steel 1.5mm orifice (#5.5 nozzle equivalent)



Part No	Original No.	Description
8.710-125.0	344030	Foam Cannon / Injector
8.710-126.0	344032	Foam Cannon / Injector / Bottle
8.704-222.0	113011	Replacement Turbulator Screen

Air-Power Sprayers

- Pump-up style
- Heavy-duty plastic sprayers for chemical applications
- Both models have Adj. Nozzle — from mist to solid stream
- 2-gallon unit has 2' hose and hand trigger
- Excellent chemical resistance
- Locking hand pump handle serves as carrying handle



Part No	Original No.	Description
8.704-703.0	118842	Thumb Button 3 Pint
8.704-702.0	118835	2-Gallon Sprayer

Foam Jet Kit

AP

Long-distance foam applicator. Shoots OVER 20 FEET of dense foam. Suction at 30 feet of height. Variable spray pattern.

- 5000 PSI
- 5.6 GPM
- 14" inlet
- 140°F
- 33' Tube



Part No	Description
8.750-296.0*	Kit, Foam Jet, 5000 PSI, 5.6 GPM
8.750-429.0	Kit, Repair, Foam Jet Orings / Stainless-Steel Filter
8.750-430.0	Kit, Repair, Foam Jet, Hose / Valve / Filter

* Includes tubing and fittings as shown

Lafferty Airless Foam Kit

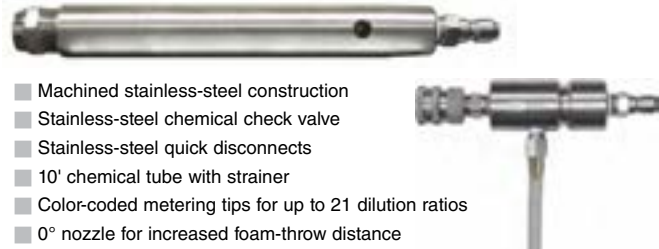

- Machined stainless-steel construction
- Stainless-steel chemical check valve
- Stainless-steel quick disconnects
- 10' chemical tube with strainer
- Color-coded metering tips for up to 21 dilution ratios
- 0° nozzle for increased foam-throw distance

Part No	Flow Rate@2000 PSI	@ 137.9 bar
8.749-908.0 (Model 10)	4.0 GPM	15.1 LPM
8.749-909.0 (Model 20)	6.0 GPM	22.7 LPM

Adjustable Foamer with Tank

Control the foam spray angle with the variable fan nozzle.

- PSI: 2600
- GPM: 5.3
- 140°F
- Horizontal variable fan nozzle
- Foam control adjustment knob



Part No	Description
8.710-124.0	Adjustable Foamer w/ Tank

Teflon® Thread Sealing Tape

- Big 1/2" x 520" roll
- Mil — spec #T27730



Part No	Original No.	Description
8.704-705.0	118905	Thread Sealing Tape

Thread Lock Products

- Direct replacement for LocTite® and Fel-Pro™ products
- Excellent lubricant; prevents corrosion and fretting
- ND™ anaerobic adhesives are liquid materials that cure to a solid, chemical-resistant plastic state when air is not present

Part No	Old No	Description	LocTite® Equiv	Bottle Size
8.704-644.0	112350	Nut Grade™	242	10 ml
8.704-645.0	112352	Nut Grade™	242	50 ml
8.704-646.0	112354	Nut Grade™	242	250 ml
8.704-648.0	112360	Stud Grade™	271	10 ml
8.704-649.0	112362	Stud Grade™	271	50 ml
8.704-650.0	112367	Penetrating Adhesive (Sealant)	290	10 ml

Nut Grade™ and Stud Grade™ are trademarks of the Oakland Corp. LocTite® is a registered trademark of the LocTite Corp.



Gloves – Industrial Duty

Industrial-grade gloves for most industry-needs — chemical / heat / abrasion / laceration protection.

8.704-669.0

- Black, 14" PVC glove lined with cotton for the most demanding chemical handling. Resists alkalines, acids — even works well as a sandblasting glove.



8.704-668.0

- Gray – Split Cowhide work gloves, 2-1/2" gauntlet unlined — great general purpose work glove.

Part No	Original No.	Description
8.704-668.0	116105	Gray Roughout
8.704-669.0	116114	Black PVC

Rain Suit – 2-Piece

- Heavy-duty, 2-ply laminated vinyl (25 mil)
- Jacket and pants
- Bright safety yellow
- Vented for air flow



Part No	Original No.	Description
8.704-666.0	116100	Large
8.704-667.0	116101	Extra Large

Amazing Pocket Reference – Third Edition

A ton of information in a 5 oz book!

- Air and gases, Chemistry, Math
- Plumbing and pipe, Electrical, Automotive
- Electrical, Automotive
- Physical constants
- 3350 conversion factors
- Over 20 other subject areas



Part No	Original No.	Description
8.712-505.0	449015	Pocket Reference

Shipping Tape and Dispenser

Big 2" x 110 yard rolls of clear. Biaxially-oriented polypropylene for secure packages.

- Heavy-duty tape dispenser with serrated blade



Part No	Original No.	Description
8.704-707.0	118916	Dispenser Boxed
8.901-249.0	118918	110 Yard Roll

Profit From Power Washing

Geared specifically to determining the profitability, feasibility, and marketability of owning a pressure washing business. It covers the methodology so crucial in both starting and operating a pressure washing service. Topics covered include:

- Marketable services
- Equipment selection
- Equipment use
- Personal safety
- Target markets
- Customer relations
- Estimating
- Advertising
- Chemical selection and use
- Important legal issues
- Much more...



Part No	Description
8.750-507.0	Profit From Power Washing

Yamada Pumps



Air-powered double diaphragm pump, "Reliable Performance Since 1905". The answer to difficult product transfer problems. Air-drive allows freedom from electrical hazards or explosion-proof motor requirements. Choose from various wetted-parts materials to customize the pump to the chemical being pumped. Yamada's smaller pumps are often used for pumping car wash chemical for 'low-pressure' functions. The 1/2" pump is also ideal for rapidly pumping oil, soap, etc., from 55 gallon barrels. Larger pumps are used for high-volume product transfer. Since all pumps are designed without rotating parts, they can also handle abrasive liquids such as ceramic slip, sand slurry, or enamel frit without damage. Have a unique challenge? Call us for help!

- 100 PSI / 180°F
- Environmentally-friendly non-lube air valve
- Automatic start/stop
- Non-stalling air valve — positive switching every stroke and won't ice up
- Outside accessible air valve — easy inspection and maintenance
- Bolted flange connections — leak-free and easy maintenance
- Built-in abrasion and chemical-resistance
- Virgin diaphragm materials last twice as long as other pumps
- 1/4" model deliver 3.4 GPM with 20-100 PSI drive air
- 1/2" models deliver 15 GPM with 20-100 PSI drive air
- 3/4" models deliver 19.5 to 27.3 GPM with 20-100 PSI drive air
- 1" models deliver 35.7 to 48.3 GPM with 20-100 PSI drive air
- Infinitely variable flow control regulated by opening or closing discharge side valve and/or fluctuating air supply



8.702-180.0



8.702-183.0

Part No	Old No	Intake and Discharge	Air Inlet w/ball valve	Air Exhaust w/B-I muffled	Pump Body	Diaphragm Material	Max Flow @ 100 PSI	Max Solid
8.702-180.0	100381	1/4" FPT	1/4" FPT	3/8" FPT	Poly	Teflon [®]	3.4 GPM	N/A
8.702-181.0	100382	1/4" FPT	1/4" FPT	3/8" FPT	Kyn	Teflon [®]	3 GPM	N/A
8.702-200.0	100410	3/8" FPT	1/4" FPT	3/8" FPT	Poly	Teflon [®]	6 GPM	1/32"
8.702-201.0	100411	3/8" FPT	1/4" FPT	3/8" FPT	Poly	Santoprene [®]	6 GPM	1/32"
8.702-182.0	100383	1/2" FPT	1/4" FPT	3/8" FPT	Poly	Hytrel [®]	15 GPM	1/32"
8.702-183.0	100384	1/2" FPT	1/4" FPT	3/8" FPT	Poly	Santoprene [®]	15 GPM	1/32"
8.702-184.0	100385	1/2" FPT	1/4" FPT	3/8" FPT	Poly	Teflon [®]	15 GPM	1/32"
8.702-187.0	100391	3/4" FPT	1/4" FPT	3/4" FPT	Poly	Neoprene	27.3 GPM	1/16"
8.702-188.0	100392	3/4" FPT	1/4" FPT	3/4" FPT	Poly	Buna-N	27.3 GPM	1/16"
8.702-189.0	100393	3/4" FPT	1/4" FPT	3/4" FPT	Poly	Hytrel [®]	27.3 GPM	1/16"
8.702-190.0	100394	3/4" FPT	1/4" FPT	3/4" FPT	Poly	Teflon [®]	27.3 GPM	1/16"
8.702-191.0	100395	3/4" FPT	1/4" FPT	3/4" FPT	Alum	Buna-N	27.3 GPM	1/16"
8.702-192.0	100396	1" FPT	3/8" FPT*	3/4" FPT	Poly	Neoprene	48.3 GPM	3/16"
8.702-193.0	100397	1" FPT	3/8" FPT*	3/4" FPT	Poly	Hytrel [®]	48.3 GPM	3/16"
8.702-194.0	100398	1" FPT	3/8" FPT*	3/4" FPT	Poly	Teflon [®]	48.3 GPM	3/16"
8.702-195.0	100399	1" FPT	3/8" FPT*	3/4" FPT	Alum	Hytrel [®]	35.7 GPM	3/16"
8.702-202.0	100415	1-1/2" FPT	1/2" FPT*	3/4" FPT	Alum	Buna-N	116 GPM	9/32"

*With air-cock instead of ball valve

Diaphragm Kits for Yamada Pumps

To minimize downtime, Yamada pumps are designed for quick, trouble-free maintenance. Pump diaphragms, balls and seats can be replaced in 20 minutes or less and with little chance of leaks commonly associated with other diaphragm pumps.

- Kits include everything required for routine Maintenance



Part No	Old No	Kit	Pump Size	Yamada Pump No.
8.703-277.0	105004	Teflon [®]	1/4"	100381
8.703-278.0	105006	Hytrel [®]	1/2"	100383
8.703-279.0	105008	Santoprene	1/2"	100384
8.703-281.0	105010	Teflon [®]	1/2"	100385
8.703-282.0	105012	Neoprene	3/4"	100391
8.703-283.0	105014	Buna	3/4"	100392

Part No	Old No	Kit	Pump Size	Yamada Pump No.
8.932-947.0	105018	Teflon [®]	3/4"	100394
8.703-284.0	105022	Neoprene	1"	100396
8.703-285.0	105024	Hytrel [®]	1"	100397
8.703-286.0	105026	Teflon [®]	1"	100398
8.703-320.0	105150	Buna	1-1/2"	100415

NOTE: Individual components (O-rings or diaphragms only, for example) also available.

Air-Operated Pump



Twin diaphragm, self-priming, 7.0 GPM.

- Santoprene elastomers
- Dry air (or CO2) 20-120 PSI
- 7.0 GPM
- 120°F max liquid temperature
- Self-priming up to 15 feet
- Air (gas) in and out, 1/4" barb
- Choice of 3/8" or 1/2" barb fluid in/out
- Automatic, on-demand start and stop
- Flow control via air (gas) pressure
- Common uses: chemical transfer and dispensing parts, washers, and car wash systems



Part No.	Original No.	Description
8.702-321.0	100874	3/8" Pump (Santoprene)
8.702-322.0	100874A	3/8" Pump (Viton)
8.702-323.0	100875	1/2" Pump (Santoprene)
8.702-324.0	100875A	1/2" Pump (Viton)

Air-Driven Pump



Twin diaphragm, self-priming, 1.9 GPM.

- Santoprene or Viton elastomers: Use Santoprene for soaps, use Viton for butyls
- Dry air (or CO2) 20-80 PSI
- 1.9 GPM
- Chemical in and out, 3/8" barb
- Air (gas) in and out, 1/4" barb
- Automatic, on-demand start and stop
- Control flow and pressure with air pressure



Part No	Old No	Description
8.702-320.0	100873	Pump (Santoprene)
8.702-319.0	100872	Pump (Viton)
8.700-387.0	075862	Diaphragm Kit (Santoprene)
8.700-388.0	075863	Valve Kit (Santoprene)
8.700-418.0	075907	Diaphragm Kit (Viton)
8.700-419.0	075908	Valve Kit (Viton)

Air Filter / Regulators

- 1/4" ports
- 125 PSI
- Pressure-relieving
- Removes air line impurities to 5 microns
- Maintains and gauges pressure to, and therefore discharges pressure from, air-driven diaphragm pumps



8.712-585.0



8.712-586.0

Part No	Old No	Description
8.712-585.0	462280	Regulator Only
8.712-586.0	462285	Filter/Regulator
8.712-587.0	462290	Gauge, 0-1 60, 1/8"

Foam Brush and Accessories

Foam Brush Head
3" x 10" supersoft flagged bristle fountain brush. Choose from black, red or blue.



Foam Brush Lance
40" long with 30" insulated grip, 3/8" FPT inlet, 1/2" MPT outlet (matches brush inlet). Colors: red, blue, or black.



Brush Hoses
Clear, spiral wire braid, 1/2" ID with 3/8" MPT, zinc-plated steel fittings both ends.

Part No	Old No	Description
8.710-115.0	344006	Foam Brush Head, Black
8.710-117.0	344006RED	Foam Brush Head, Red
8.710-116.0	344006BLU	Foam Brush Head, Blue
8.710-118.0	344010	Foam Hose (12')
8.710-119.0	344011	Foam Hose (15')
8.710-121.0	344014	Lance 40", Red
8.710-122.0	344014BLK	Lance 40", Black
8.710-123.0	344014BLU	Lance 40", Blue

Car Wash Booms - "Reflex"

The performance leader!

- 5'6" car wash model
- 8' truck wash model
- 3000 PSI
- Stainless-steel boom arm
- 3/8" FPT inlet/outlet hose included



Part No	Old No	Description
Booms		
8.903-620.0	306660X	180° Wall Mount 5'6" Boom
8.903-621.0	306662X	360° Ceiling Mount 5'6" Boom
8.903-624.0	306665X	180° Wall Mount 10' Boom
8.903-625.0	306666X	360° Ceiling Mount 10' Boom
8.903-626.0	306667X	180° Wall Mount 8' Boom
8.903-627.0	306668X	360° Ceiling Mount 8' Boom
Parts / Accessories		
8.903-622.0	306663X	5.5' Rod/Hose, Assy Only
8.903-623.0	306664X	8' Rod/Hose, Assy Only
8.903-628.0	306669X	10' Rod/Hose, Assy Only
8.903-630.0	306670X	Ceiling Mount, Base Only
8.903-632.0	306672X	Wall Mount, Base Only
8.700-265.0	075064X	Set Screw for Angle Block
8.905-605.0	568612	90° End Coupler C/W Boom
8.905-604.0	568610	8' Coupler Stainless-Steel C/W Boom
8.712-450.0	421020	Swivel - Brass 3/8"
8.700-263.0	075060	Swivel Repair Kit (pre-1998)
8.700-287.0	075130	Swivel Repair Kit (1998-present)

CAR WASH BAY ACCESSORIES

Stainless-Steel Bay Accessories

Foam brush boom holder, wand holders, mat clamps.



Part No	Old No	Description
8.708-880.0	260600	Standard Foam Brush Holder
8.708-881.0	260605	Rigid Wall Mount Wand Holder
8.708-882.0	260606	Flex Bottom Mount Wand Holder
8.708-883.0	260610	Mat Clamp

Locks for Meter Boxes



8.708-731.0

8.708-730.0

Part No	Old No	Description
8.708-731.0	260064	Disk Lock (Master Brand)
8.708-730.0	260062	Tubular Cam Lock

Rotary Switch - 8-Position

Metal car wash switch.

- Double stack 8-position
- Metal
- Much more durable than cheaper plastic switches
- Direct replacement for Electroswitch 31302A-S and NU32LA
- Make before break functions



Part No	Old No	Description
8.708-729.0	260061	8-Position Rotary Switch

Transformers



8.708-780.0



8.708-784.0

Part No	Old No	Description
8.708-780.0	260311	115-24V AC: 600 MIL/AMP
8.708-781.0	260312	115/208/230-24V AC: 100V A Fused
8.708-783.0	260315	120/208/240-24V AC: 50V A
8.708-784.0	260316	120/208/240- 24V A Not Fused

Fuses



Part No	Old No	Description
8.708-786.0	260324	Transformer fuse 5 Amp (For P/N 260312)

Medium-Pressure Swivels

- 1000 PSI
- 7/16" flow-thru opening
- All-brass body
- Bronze-thrust bearing
- Buna seals (non-repairable)
- 1/2" FPT x 1/2" MPT



Part No	Old No	Description
8.705-057.0	140094	Swivel

Low-Pressure Swivels

- 300 PSI swivel action
- Brass MPT
- Zinc-chromate steel FPT



Part No	Old No	Description
8.705-054.0	140085	1/4" FPT x 1/4" MPT
8.705-056.0	140087	3/8" FPT x 3/8" MPT
8.705-055.0	140086	1/2" FPT x 1/2" MPT

Flex Lances



- 2500 PSI
- 200°F
- Flexes 180° and returns
- Prevents bent lances and broken hoses
- Industrial-grade polyurethane flex section
- Perfect for self-serve car wash bays
- 1/4" galvanized pipe end sections

Part No	Old No	Length / Color	Description
8.710-600.0	368119BLK	18" Black	1/4" MPT x 1/8" FPT
8.710-601.0	368119BLU	18" Blue	1/4" MPT x 1/8" FPT
8.710-603.0	368121	21" Red	1/4" MPT x 1/8" FPT
8.710-604.0	368124	24" Red	1/4" MPT x 1/8" FPT
8.710-598.0	368118	18" Red	1/4" MPT x 1/4" MPT

Vacuum Accessories

May slip directly on to hose. Use with swivel cuffs for better results.



Vacuum Claw Nozzle

Part No. 1-1/2"	Old No	Part No. 2"	Old No	Color
8.708-893.0	260917	8.708-895.0	260919	Orange
8.708-892.0	260916	8.708-894.0	260918	Yellow
8.708-891.0	260915	8.708-897.0	260921	Black
8.708-890.0	260914	8.708-899.0	260923	Gray

Couplings

Part No	Old No	Description
8.708-896.0	260920	1-1/2"
8.708-898.0	260922	2"

Adapter



Part No	Old No	Description
8.708-900.0	260924	2" Hose x 1-1/2" Wand
8.708-904.0	260942	2" Hose x 2" Wand

Vacuum Nozzles



Part No	Old No	Description	Degree
8.708-901.0	260932	1-1/2" x 1-1/2" x 5-1/4"	45°
8.708-902.0	260934	2" x 2" x 5-1/2"	45°

Cuffs, Hose to Tank



Part No	Old No	Description
8.708-903.0	260940	1-1/2" x 1-1/2"
8.708-904.0	260942	2" x 2"
8.708-905.0	260944	1-1/2" x 1-1/2" Swivel
8.708-906.0	260946	2" x 2" Swivel

Wash Gun - RB65



Low-pressure spray gun with straight jet and adjustable cone from the trigger with adjustable screws to alter cone angle wideness from 0° to 60°.

- 195°F
- 16 GPM
- Completely sealed
- Ergonomic
- Adjustable jet cone
- Trigger protection
- Brass body
- Inlet connection swivel
- 350 PSI-rated pressure



Part No	Old No	Description
8.710-449.0	353265	PA RB65 w/ Awivel
8.710-448.0	353264	PA RB65 No Swivel

Car Wash Vacuum Hose CW150 and CW200

ULTIMATE
CRUSH-PROOF

The most flexible, easy-to-handle vacuum hose ever!

- Recovers immediately from crush
- Tough and durable
- Resists ultraviolet rays and abrasion
- Smooth interior bore for max air flow
- CW150 = 1-1/2"; CW200 = 2"



Part No	Old No	Size
8.708-907.0	260950	1.5" x 15'
8.708-909.0	260954	1.5" x 25'
8.708-910.0	260956	1.5" x 50'
8.708-917.0	260962	2" x 15'
8.708-919.0	260966	2" x 25'
8.708-920.0	260968	2" x 50'

AP Vacuum Motors



8.625-841.0



8.620-204.0



8.625-842.0

Part No	Description
Two Fan Stages, Bypass Motors	
8.625-841.0	5.7" Diameter, 120V Double Ball Bearing, Peripheral Discharge
8.620-204.0	Vault system Vac Motor: 120V Double Ball, Bearings, Tangent Discharge
Three Fan Stages, Bypass Motors	
8.625-842.0	5.7" Diameter, 120V Double Ball Bearings, Tangent Discharge

CAR WASH BAY ACCESSORIES

Ametek-Lamb Vacuum Motors

Part No	Description
Two Fan Stages, Bypass Motors	
8.685-502.0	5.7" Diameter, 120V Double Ball Bearing, Peripheral Discharge
8.685-442.0	Vault system Vac Motor: 120V Double Ball, Bearings, Tangent Discharge
Three Fan Stages, Bypass Motors	
8.685-458.0	5.7" Diameter, 120V Double Ball Bearings, Tangent Discharge



8.685-502.0



8.685-442.0



8.685-458.0

Connector Hose / Car Wash Bay Hose – 12'-25'

All car wash bay hoses come with solid male pipe on both ends.



Part No	Length	PSI
3/8" Black – 1 wire		
8.918-333.0	12'	4000
8.918-334.0	13'	4000
8.918-336.0	14'	4000
8.918-338.0	15'	4000
8.918-340.0	16'	4000
8.918-342.0	17'	4000
8.918-344.0	18'	4000
8.918-348.0	20'	4000

Part No	Length	PSI
1/4" Black – 1 wire		
8.918-312.0	15'	3000
8.918-322.0	20'	3000
8.918-329.0	24'	3000
8.918-331.0	25'	3000

Part No	Length	PSI
3/8" Blue – 1 wire		
8.918-360.0	12'	3000
8.918-362.0	13'	3000
8.918-364.0	14'	3000
8.918-366.0	15'	3000
8.919-124.0	16'	3000
8.918-369.0	17'	3000
8.918-371.0	18'	3000
8.918-373.0	19'	3000
8.918-375.0	20'	3000
8.918-377.0	21'	3000
8.918-379.0	22'	3000
8.918-381.0	23'	3000
8.918-383.0	24'	3000
8.918-385.0	25'	3000

Part No	Length	PSI
1/4" Blue – 1 wire		
8.918-387.0	12'	3000
8.918-389.0	13'	3000
8.918-391.0	14'	3000
8.918-393.0	15'	3000
8.918-395.0	16'	3000
8.918-397.0	17'	3000
8.918-399.0	18'	3000
8.918-401.0	19'	3000
8.918-403.0	20'	3000
8.918-405.0	21'	3000
8.918-407.0	22'	3000
8.918-409.0	23'	3000
8.918-411.0	24'	3000
8.918-413.0	25'	3000

Solenoid Valves



- Air
- Professional car washes
- Low pressure steam
- Light oil
- Chemicals
- Other industrial applications

Water Solenoid Valves 2-way, normally closed. The S211 Series Standard Water Valves have reliable piloted diaphragm construction with proven performance over decades of use. Featuring stainless-steel seats, the S211 Series typically requires 4 or 5 PSI pressure differential to open. The S201 Series Zero Differential Valves are constructed with the same materials, but are capable of operating with the same amount of pressure on both sides of the valve. Both valve types are often utilized in the car wash industry.



High-pressure Solenoid Valves 2-way, normally closed. The S401 High-Pressure Valves are compact, dependable and specially designed by ITT to meet car wash applications up to 1400 PSI. Best Buy



Chemical Solenoid Valves 2-way, normally closed. For decades, car wash industry professionals have chosen the rugged S301 and S311 Series Valves because of their compact size and long life. Available in 1/8", 1/4" and 3/8" NPT designs, these valves are used in air, water and chemical applications.



Normally Open Solenoid Valves for Car Wash Anti-Freeze Applications. These valves provide long life and reliable performance in the "make or break" anti-freeze systems of car washes. The S202 and S212 Series Diaphragm Valves feature non-wicking, fabric-reinforced diaphragms, which eliminates premature diaphragm failures, as well as stainless-steel upper seats, which prevents seat deterioration often associated with brass-seated valves. The S202 Series Diaphragm Valve incorporates the zero-operating pressure design discussed above; the S212 Series is a piloted diaphragm, and the S402 Series is a piloted piston valve.

Solenoid Valve Specifications – continues on next page



- | | | | |
|----------------------|-----------|-----------------------|------------------------|
| Body Seals | Mode | Type | |
| BR = Brass | B = Buna | N/O = Normally Open | PD = Piloted Diaphragm |
| SS = Stainless-steel | V = Viton | N/C = Normally Closed | PP = Piloted Piston |
| | | DA = Direct Acting | |

Part No	Old No	GC Part No.	Port F-NPT / Body	Orifice	Oper PSI	Seals	Mode	Type / AC Volts	DEMA Equiv
8.708-805.0	260450	S201-CG4	3/8" / BR	.312"	150	B	N/C	PD / 24	A413P-24
8.708-806.0	260451	S201-CG4	3/8" / BR	.312"	150	B	N/C	PD / 110	A413P-110
8.708-807.0	260452	S201-DG4	1/2" / BR	.438"	150	B	N/C	PD / 24	A414P-24
8.708-808.0	260453	S201-DG4	1/2" / BR	.438"	150	B	N/C	PD / 110	A414P-110
8.708-810.0	260454	S201-EG5	3/4" / BR	.593"	150	B	N/C	PD / 24	A416P-24
8.708-811.0	260455	S201-EG5	3/4" / BR	.593"	150	B	N/C	PD / 110	A416P-110
8.708-812.0	260456	S201-FG9	1" / BR	.760"	150	B	N/C	PD / 24	A418P-24
8.708-813.0	260457	S201-FG9	1" / BR	.760"	150	B	N/C	PD / 110	A418P-110
8.708-820.0	260464	S211-CG4	3/8" / BR	.625"	150	B	N/C	PD / 24	473P-24
8.708-821.0	260465	S211-CG4	3/8" / BR	.625"	150	B	N/C	PD / 110	473P-110
8.708-822.0	260466	S211-DG4	1/2" / BR	.625"	150	B	N/C	PD / 24	474P-24
8.708-823.0	260467	S211-DG4	1/2" / BR	.625"	150	B	N/C	PD / 110	474P-110
8.708-824.0	260468	S211-EG5	3/4" / BR	.750"	150	B	N/C	PD / 24	476P-24
8.708-825.0	260469	S211-EG5	3/4" / BR	.750"	150	B	N/C	PD / 110	476P-110
8.708-826.0	260470	S211-FG9	1" / BR	1.00"	150	B	N/C	PD / 24	—
8.708-827.0	260471	S211-FG9	1" / BR	1.00"	150	B	N/C	PD / 110	—
8.708-828.0	260479	S301-AD5	1/8" / BR	.101"	125	B	N/C	DA / 110	491P-110
8.708-829.0	260480	S301-BD7	1/4" / BR	.109"	150	B	N/C	DA / 24	401P-24
8.708-830.0	260481	S301-BD7	1/4" / BR	.109"	150	B	N/C	DA / 110	401P-110
8.708-814.0	260458	S202-CG4	3/8" / BR	.281"	150	B	N/O	PD / 24	0412P-24
8.708-815.0	260459	S202-CG4	3/8" / BR	.281"	150	B	N/O	PD / 110	0412P-110
8.708-816.0	260460	S202-DG4	1/2" / BR	.438"	150	B	N/O	PD / 24	0A414P-24
8.708-817.0	260461	S202-DG4	1/2" / BR	.438"	150	B	N/O	PD / 110	0A414P-110
8.708-818.0	260462	S202-EG5	3/4" / BR	.593"	150	B	N/O	PD / 24	0A416P-24
8.708-819.0	260463	S202-EG5	3/4" / BR	.593"	150	B	N/O	PD / 110	0A416P-110
8.708-831.0	260482	S301-BD7	1/4" / SS	.125"	150	V	N/C	DA / 24	424-2-24
8.708-832.0	260483	S301-BD7	1/4" / SS	.125"	150	V	N/C	DA / 110	424-2-110
8.708-833.0	260484	S401-Z	3/8" / SS	.350"	1200	V	N/C	PP / 24	453P-24
8.708-834.0	260485	S401-Z	3/8" / SS	.350"	1200	V	N/C	PP / 110	453P-110
8.708-835.0	260486	S401-Z	1/2" / SS	.500"	1200	V	N/C	PP / 24	454P-24
8.708-836.0	260487	S401-Z	1/2" / SS	.500"	1200	V	N/C	PP / 110	454P-110

Replacement/Repair Kits for Solenoids Valves – continued

Part No	Old No	Description
8.708-837.0	260488	24V AC Coil
8.708-838.0	260489	110V AC Coil
8.700-214.0	074801	Repair Kit – S301–1/4" valves (Buna)
8.700-215.0	074802	Repair Kit – S201–3/8" and 1/2" valves (Buna)
8.700-216.0	074806	Repair Kit – S202–3/4" valves (Buna)

Part No	Old No	Description
8.700-217.0	074807	Repair Kit – S301–1/4" valves (Viton)
8.700-218.0	074808	Repair Kit – S401–3/8" and 1/2" valves (Viton)
8.700-219.0	074809	Repair Kit – S211–3/8" and 1/2" valves (Buna)
8.700-220.0	074810	Repair Kit – S211–3/4" valves (Buna)
8.700-221.0	074812	Repair Kit – S211– 1-1/4", 1-1/2" and 2" valves (Buna)

Kip Solenoids

- Reliable over years of use
- Millions of cycles life not unusual
- All with FPT ports
- N/O = Normally Opened
- N/C = Normally Closed
- N/A= Not Adjustable
- C/A = Chemical Adjustment



8.708-846.0



8.708-849.0



Part No	Old No	FPT	Voltage	Orifice ID
Stainless-steel				
8.708-846.0**	260511	N/C	1/4" 24V AC	N/A .062
8.708-847.0**	260515	N/O	1/4" 24V AC	N/A .062
8.708-849.0	260520	N/C	1/8" 24V AC	N/A .062
8.708-851.0	260525	N/C	1/4" 24V AC	C/A
8.708-852.0*	260526	N/C	1/4" 24V AC	C/A
8.708-853.0	260530	N/C	1/8" 24V AC	C/A
8.708-855.0	260534	N/C	1/4" 120V AC	N/A .093
8.708-856.0	260535	N/C	1/4" 24V AC	N/A .093
8.708-857.0*	260536	N/C	1/4" 120V AC	N/A .093
8.708-858.0*	260537	N/C	1/4" 24V AC	N/A .093
Brass Solenoid Valves – Kip				
8.708-863.0*	260546	N/C	1/8" 240V AC	N/A .062
8.708-864.0*	260547	N/C	1/8" 120V AC	N/A .062
Parts				
8.708-859.0	260538	Coil Only 120V	Wire Leads	
8.708-860.0	260539	Coil Only 24V	Wire Leads	
8.708-862.0	260542	Coil Only 24V	Spade Term	
8.708-861.0	260541	Repair Kit N/C 1/4"		

*Conduit Body Style w/ wire leads **Wire Leads

Solenoids w/ Built-In Strainer

For pressure lines and pressure systems only.

Brass Valves – Diaphragm Style



- Normally closed valve operation
- Rated to 200°F fluid and 120°F ambient
- Proven design features for reliable performance on all applications
- Operates in any position, but do NOT mount valve with coil under valve

Part No	Old No	DEMA No.	FPT	Orifice	PSI	Voltage
8.711-249.0	396115	442P	1/4"	.25	125	24V AC
8.711-250.0	396116	442P	1/4"	.25	125	110V AC
8.711-252.0	396119	443P	3/8"	.25	125	24 V AC
8.711-253.0	396120	443P	3/8"	.25 1	25	110V AC

Celcon Plastic Valves - Super for strong chemicals.



- Diaphragm style with Y-screen (S.S.)
- Molded coil CSA-approved
- Compact design — 1/4" spade connects
- Normally closed operation
- 125 PSI
- 180°F
- 1/4" FPT, 1/4" orifice

Part No	Old No	DEMA No.	FPT	Orifice	PSI	Voltage
8.708-869.0	260560	P442	1/4"	.25	125	24V AC
8.708-870.0	260561	P442	1/4"	.25	125	110V AC
8.708-871.0	260562	P442	1/4"	.25	125	12V AC
8.708-872.0	260566	P443	3/8"	.25	125	24V AC
8.708-873.0	260567	P443	3/8"	.25	125	110V AC
8.708-874.0	260568	P443	3/8"	.25	125	12V DC

Aqua Master™ Model 440

DEMA

Liquid level proportioning controls — automatically maintain drum level and chemical concentration. The Aqua Master automatically maintains a desired level of proportioned mixture in a drum, tank or other type reservoir.

Magnetically activated “snap acting” float valves provide full water flow to activate the chemical proportioners. There are two basic sizes to give a choice of water flows as shown in the table below. Chemical feed rate is adjusted by metering screw or threaded metering tips. The compact 440 float valve is made of Celcon® plastic and is easily accessible for field maintenance.

Liquid-level proportioning controls are available in two flow capacities, 4 and 22 GPM at 50 PSI. Either size can be used with or without a proportioner. The proportioner allows chemical to be inducted while the valve is open.

All models, except as noted, are equipped with siphon breakers to prevent backflow into the fresh water line. The proportioner discharge is provided with means for attaching a hose or piece of pipe for under water feeding to minimize sudsing.

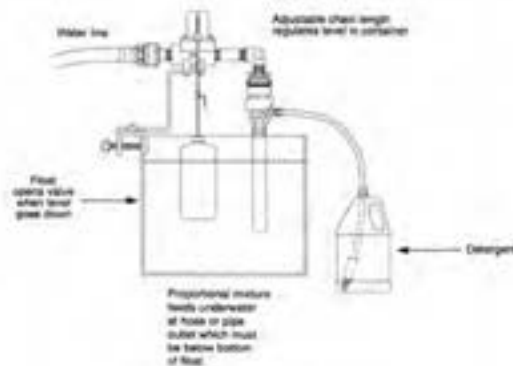

Model	Description	Capacity
440-23BT	Proportioning Valve, 4 GPM Flow at 50 PSI, Medium Capacity	12*
440-23T	Proportioning Valve, 4 GPM Flow at 50 PSI, High Capacity	35*
440-24	Proportioning Valve, 4 GPM Flow at 50 PSI, Highest Capacity	70*
437-21	Proportioning Valve, 22 GPM Flow at 50 PSI, Medium Capacity	10*

*Oz / Gal of 1 CPS Fluid (ie, Viscosity of Water)

Part No	Old No	Description
8.710-525.0	360382	440-23BT
8.710-524.0	360381	440-23T
8.710-526.0	360383	440-24
8.710-532.0	360397	437-21
8.710-534.0	360399	Optional Tips

Erie Motortrol® Valve

- Three-way valve to switch hot and cold inlets to single outlet
- 1/2" MPT (all three)
- 24V AC



Part No	Old No	Description
8.708-879.0	260580	Motortrol Valve

Proportioners

Designed to blend liquid chemical concentrates with water (flowing at normal city water pressure) to create an accurate mix of diluted chemicals. Complete with metering orifice set and/or metering adjustment valve.

- 1 CPS = Viscosity of Water
- 75 CPS = Viscosity of SAE 10 oil
- 220 CPS = Viscosity of SAE 30 oil



Model	Description	Capacity	
MAX BLEND RATE = Oz Chem Per Gal Water			
MODEL No.	1 CPS	75 CPS	220 CPS
162	24	14	6
163H*	64	30	14

*High-concentration chemical blender

Part No	Old No	Description
8.710-530.0	360393	#162 Drum Mount with Proportioner
8.710-529.0	360392	#163H High Concentrate Proportioner Low Side
8.700-226.0	074903	Polypropylene Foot Valve
8.710-534.0	360399	Optional Tips

PARTS WASHER PARTS

Seals & Gaskets

Part No.	Old No	Description	Unit
8.712-860.0	500.110	Seal - Edge Guard, Vinyl (Pebble Finish)	FT
8.713-319.0	500.770	Seal - Bulb Type Side Profile, NBR Rubber, 7230	FT
8.714-344.0	502.426	Seal - Door Bottom 7530 (ECH Rubber 60 Duro(A))	EA
8.714-345.0	502.427	Seal - Door Bottom 7650,7660 (ECH Rubber 60 Duro(A))	EA
8.714-341.0	502.423	Seal - Door Cabinet Side 7530 (ECH Rubber 60 Duro(A))	EA
8.714-346.0	502.428	Seal - Door Cabinet Side 7650 (ECH Rubber 60 Duro(A))	EA
8.714-350.0	502.432	Seal - Door Cabinet Side 7660 (ECH Rubber 60 Duro(A))	EA
8.714-342.0	502.424	Seal - Door Latch Side 7530 (ECH Rubber 60 Duro(A))	EA
8.714-347.0	502.429	Seal - Door Latch Side 7650 (ECH Rubber 60 Duro(A))	EA
8.714-351.0	502.433	Seal - Door Latch Side 7660 (ECH Rubber 60 Duro(A))	EA
8.714-343.0	502.425	Seal - Door Top 7530 (ECH Rubber 60 Duro(A))	EA

NOTE: 502.644 is replacing 501.782

Filters & Baskets

Part No.	Old No	Description	Unit
8.705-952.0	200.161	Bag - Filter 150 Micron, Nylon, 18" x 14", 1816, 7220	EA
8.714-474.0	502.650	Bag - Filter 100 Micron, Krystle Klear, 8" x 30"	EA
8.731-254.0	200.162	Basket - Small Parts, 8" x 8" x 4"	EA



8.705-952.0

Heating Elements & Thermostats

Part No.	Old No	Description	Unit
8.716-653.0	502.379	Heating Element - 1250 W 120V	EA
8.712-813.0	500.045	Heating Element - 4.5 KW 230V 1", 1PH 1" NPT	EA
8.712-954.0	500.238	Heating Element - 9 KW 230V, 3PH 2" NPT	EA
8.713-030.0	500.338	Thermostat - Bulb & Capillary - 195°F (For 3-Phase Machines)	EA
8.713-723.0	501.348	Heating Element - 2 KW 120V	EA
8.713-593.0	501.148	Thermostat - S-p DBC 180°F	EA



8.712-813.0



8.713-030.0



8.713-593.0

Handles

Part No.	Old No	Description	Unit
8.712-818.0	500.054	Handle - Lid/Door (Glass Reinforced Nylon-Black) (7" O.C. Hole Pattern)	EA
9.804-203.0	500.521	Handle - Door/Strainer (Small)	EA

■ Non-conductive

■ Non-corrosive



8.712-818.0

Lid Supports

Part No.	Old No	Description	Unit
8.712-817.0	500.053	Gas Spring - Strut (40A) - 7230	EA
8.713-317.0	500.767	Gas Spring - Strut - 7689	EA
8.714-540.0	502.820	Gas Spring - Strut - 7320 / 2003	EA



Turntable Drive Components

Heavy duty.

Part No.	Old No	Description	Unit
8.713-730.0	501.356	Gearmotor - AC Fractional 733x & Larger	EA
8.725-371.0		Gearmotor - APW	EA
8.725-437.0		Replacement Capacitor for 8.725-371.0	EA
8.714-009.0	501.882	Torque Limiter - Large Size	EA
8.714-008.0	501.881	Torque Limiter - Standard Size	EA
9.804-423.0	501.794	Spring - Compression (864) .8750D x 2.5 L x .120	EA
8.712-903.0	500.165	Spring - Compression .105 x 1.125 x 3.5	EA
8.713-320.0	500.771	Chain w/ Connector Link 7320	EA
8.712-858.0	500.108	Chain w/ Connector Link 7230	EA
8.713-956.0	501.775	Chain w/ Connector Link (7530)	EA
8.713-957.0	501.776	Chain w/ Connector Link (7650, 7660)	EA
8.714-372.0	502.466	Chain w/ Connector Link 773x, Nickel Plated	EA
8.712-988.0	500.284	Chain w/ Connector Link 786x, Nickel Plated	EA
9.804-347.0	500.060	Bearing - Ball (Lower Turntable) Doubled Sealed	EA
9.804-346.0	500.059	Bearing - Ball (Upper Turntable) Doubled Sealed	EA
8.712-920.0	500.192	Bearing - Taper Roller Turntable 773x, 774x, 786x	EA



8.714-008.0



8.712-858.0



9.804-423.0



8.712-903.0



9.804-347.0



9.804-346.0

Timers & Switches

Easy to use and durable.



8.713-328.0



9.804-119.0



9.804-510.0

Part No.	Old No	Description	Unit
8.713-357.0	500.822	Timer - 30 Min Spring Wound, Oil skimmer	EA
8.712-832.0	500.074	Timer - 60 Min Spring Wound, Wash	EA
8.712-833.0	500.075	Timer - 12 Hour Spring Wound, Heater	EA
9.804-119.0	6-02071	Switch - Magnetic Reed Sensor N.C.	EA
9.804-118.0	6-02072	Switch - Magnetic Reed Sensor N.O.	EA
9.804-120.0	6-02073	Magnet - Reed Sensor Target	EA
8.714-018.0	501.903	Switch - Rocker (Round), TT On/Off (7230)	EA
8.713-328.0	500.787	Switch - Lighted Rocker, Skimmer/TT On/Off	EA
8.749-212.0	500.811	Switch - Limited, Enclosed	EA
9.804-510.0	500.421	Switch - (Lid/Door) 15 Amp	EA
8.713-631.0	501.208	Timer - Plug-In 20A, 7 Day 24 Hour	EA

PARTS WASHER PARTS

Pumps & Pump Seals

Heavy duty.

Part No.	Old No	Description	Unit
8.715-395.0	500.000	Pump - 1.0 HP 115/230V 1PH Cent Horz Sealed	EA
8.715-413.0	500.303	Pump - 3.0 HP 115/230V 1PH Cent Vert Sealless	EA
8.715-414.0	500.469	Pump - 3.0 HP 230/480V 3PH Cent Vert Sealless	EA
8.715-421.0	500.185	Pump - 5.0 HP 115/230V 1PH Cent Vert Sealless	EA
8.715-422.0	500.470	Pump - 5.0 HP 230/480V 3PH Cent Vert Sealless	EA
8.735-011.0	500.305	Pump - 7.5 HP 230/480V 3PH Cent Vert Sealless	EA
8.714-473.0	502.649	Seal - Pump (126) 2 Pc Viton-Silicon-Carbide (Kit) Includes O-Ring	EA
8.713-359.0	500.824	Seal - Pump (126) 2 Pc Buna-Ceramic Model 126 Pump	EA
8.713-360.0	500.825	O-Ring, Buna, Model 126 Pump	EA
8.714-320.0	502.381	Throttle Bushing - 3PH - 5PH	

Detail Components



8.712-778.0



9.804-091.0



8.712-810.0

Part No.	Old No	Description	Unit
8.712-778.0	500.004	Pump - Air Powered Diaphragm	EA
9.804-091.0	500.049	Brush - Polyplow (Flo-Thru)	EA
8.712-810.0	500.041	Regulator - 1/4" NPT	EA
8.712-835.0	500.077	Steel Cup Brush	EA

Nozzles

- 1/4" MNPT
- Hardened Steel

Part No.	Old No	Description	Unit
8.714-202.0	502.187	Nozzle - 80° #3	EA
8.712-777.0	500.003	Nozzle - 50° #3	EA
8.712-775.0	500.001	Nozzle - 50° #4	EA
8.712-973.0	500.265	Nozzle - 50° #6	EA



Measuring Cups

End the guessing game.

- Cups are calibrated for exact measurements



Part No	Description
8.697-021.0	Measuring Cups – 16 oz
8.697-024.0	Measuring Cups – 8 oz
8.697-023.0	Measuring Cups – 4 oz

Water Leveling System

Part No.	Old No	Description	Unit
9.804-095.0	500.114	Float - Poly Cylindrical (1-1/2" x x3-3/4") Water Level	EA
8.712-946.0	500.225	Float - Poly Cylindrical 2-3/4" Dia x 1-3/4" H, LWS	EA

Contactors & Relays

Part No.	Old No	Description	Unit
8.713-011.0	500.316	Contact - 3 Pole (C09), 9 Amp Inductive	EA
8.714-331.0	502.406	Contact - 3 Pole (C12), NC Aux Contacts 12 Amp Inductive	EA
8.714-330.0	502.405	Contact - 3 Pole (C16), NC Aux Contacts 16 Amp Inductive	EA
8.713-044.0	500.355	Contact - 3 Pole (C16), 16 Amp Inductive	EA
8.713-045.0	500.356	Contact - 3 Pole (C23), 30 Amps	EA
8.713-649.0	501.241	Relay - Power (25A DPDT) Surface Mount 8 Term for 110V, 7220	EA



8.713-011.0

Skimmer Components

Part No.	Old No	Description	Unit
8.904-676.0	500.687	Gearmotor - AC Fractional 6 RPM 1.03 Amp Skimmer/Drive w/ Fan	EA



8.904-676.0

PARTS WASHER PARTS

Fuses

■ Full range of fuses

■ Protect your equipment

Part No.	Old No	Description	Unit
8.749-237.0	502.206	Fuse - 1 Amp (ABC)	EA
8.713-912.0	500.796	Fuse - 10 Amp Elec. Panel 1PH	EA
8.713-078.0	500.391	Fuse - 2 Amp	EA
8.713-288.0	500.712	Fuse - 20 Amp	EA
8.713-369.0	500.847	Fuse - 25 Amp	EA
8.713-574.0	501.119	Fuse - 3 Amp	EA
8.713-291.0	500.715	Fuse - 30 Amp	EA
8.713-652.0	501.244	Fuse - 40 Amp	EA
8.749-432.0	500.708	Fuse - 50 Amp	EA
8.713-066.0	500.379	Fuse - Class CC 10 Amp	EA
8.713-067.0	500.380	Fuse - Class CC 12 Amp	EA
8.713-063.0	500.376	Fuse - Class CC 15 Amp	EA
8.713-064.0	500.377	Fuse - Class CC 3 1/2 Amp	EA
8.713-775.0	501.434	Fuse - Class CC 6 Amp	EA
8.713-529.0	501.055	Fuse - Class CC 8 Amp	EA
8.713-686.0	501.296	Fuse - Class R 1 1/2 Amp	EA
8.713-080.0	500.393	Fuse - Class R 1 Amp	EA
8.713-912.0	501.650	Fuse - Class R 10 Amp	EA
8.713-286.0	500.709	Fuse - Class R 2 Amp	EA
8.713-293.0	500.717	Fuse - Class R 20 Amp	EA
8.713-920.0	501.662	Fuse - Class R 3 Amp (1)	EA
8.713-284.0	500.707	Fuse - Class R 30 Amp	EA
8.713-878.0	501.590	Fuse - Class R 8 Amp	EA



Decals & Labels

Oil, grease and solvent resistant.

Part No.	Old No	Description	Unit
9.804-224.0*	500.290	Decal - Caution (Check Water Level...)	EA
9.804-352.0*	500.123	Decal - Danger High Voltage (All 230V, 460V, 575V)	EA
8.904-661.0*	502.342	Decal - Door Graphic, 12" x 22" (7732, 7742, 7862)	EA
8.713-298.0*	500.726	Decal - Front Sump 723x	EA
8.714-071.0*	501.988	Decal - Level Gauge (7530, 7650, 7662)	EA
9.804-223.0*	500.256	Decal - Operator Instruction (All Models)	EA
9.804-372.0*	500.334	Decal - Warning, Yellow & Black (All 230V, 460V, 575V)	EA

*items ship from Camas, WA



8.714-068.0

Misc Replacement Parts

Part No.	Old No	Description	Unit
8.713-037.0	500.347	Wheel - Polyolefin 4" x 2" (Top Load)	EA
8.712-939.0	500.213	Pin - Clevis 3/4" x 3-1/2" (Top Load)	EA
8.749-200.0	500.133	Pin - Clevis 5/8" x 2-1/4"	EA

Hyro Roller Pumps

Ideal for farm sprayers, pest control and chemical application usage.



- Housings available in cast-iron, Ni-resist or silver series
- Self-priming operation; roller pumps should not be run dry
- Adaptable to PTOs or gas engines
- Standard seals are Viton or Buna
- Standard super rollers provide the chemical resistance of nylon and long life of polypropylene
- Rotation is determined by looking at shaft end of pump
- Counter-clockwise is standard on all except 4001 and 4101 Series
- Maximum fluid temperature is 140°

Part No.	Old No	Model No.	Housing	Rotation	Shaft dia	No. of Rollers	Seals	
8.702-278.0	100814	4001C	CI	CW	5/8"	4	V	
8.702-281.0	100817	4101C	CI	CW	5/8"	4	V	
8.702-259.0	100778	4101N	N	CW	5/8"	4	V	
8.702-280.0	100815	4001XL	SL	CW	5/8"	4	V	
8.702-261.0	100784	6500C	CI	CCW	5/8"	6	V	
8.702-263.0	100784R	6500C-R	CI	CW	5/8"	6	V	
8.702-262.0	100784N	6500N	N	CCW	5/8"	6	V	
8.702-264.0	100784X	6500XL-R	SL	CW	5/8"	6	V	
8.702-282.0	100819	7560C	CI	CCW	15/16"	8	V	
8.702-283.0	100819R	7560C-R	CI	CW	15/16"	8	V	
8.702-286.0	100823R	7560N-R	N	CW	15/16"	8	V	
8.700-082.0	069665	Shaft Adapter (5/8" to 3/4")						

NOTE: CI = Cast-Iron, N = Ni-Resist, SL = Silver Last

Performance Tables



Series 4001

- Max PSI 150
- Max GPM 9
- Max RPM 1,800

Pressure in PSI	GPM @1,100 RPM	HP	GPM@1,400 RPM	HP	GPM@1,800 RPM	HP
50	4.4	.24	5.9	.32	8.0	0.46
100	3.8	.41	5.3	.56	7.3	0.78
125	3.5	.50	5.0	.68	7.0	0.95
150	3.3	.62	4.8	.78	6.7	1.10

Series 6500

- Max PSI 300
- Max GPM 18.2
- Max RPM 1,000

Pressure in PSI	GPM@1,100 RPM	HP	GPM@1,400 RPM	HP	GPM@1,800 RPM	HP
50	8.0	0.38	16.5	0.71	20.1	0.90
100	7.2	0.68	15.4	1.26	19.1	1.51
200	5.6	1.29	14.0	2.34	17.3	2.84
300	4.3	1.91	12.7	3.47	15.7	4.17

Series 4101

- Max PSI 150
- Max GPM 7
- Max RPM 2,600

Pressure in PSI	GPM@1,100 RPM	HP	GPM@1,400 RPM	HP	GPM@1,800 RPM	HP
50	4.5	0.34	5.60	.40	6.6	0.46
100	3.9	.56	5.0	.68	6.0	0.76
125	3.7	.68	.82	.82	5.7	0.92
150	3.4	.78	4.40	.96	5.4	1.08v

Series 7560

- Max PSI 300
- Max GPM 22.5
- Max RPM 1,000

Pressure in PSI	GPM@1,100 RPM	HP	GPM@1,400 RPM	HP	GPM@1,800 RPM	HP
50	11.1	0.74	17.5	1.26	22.0	1.78
100	10.3	1.25	16.9	1.95	21.3	2.53
200	8.6	2.26	15.5	3.40	20.0	4.20
300	7.1	3.30	18.9	5.30	18.0	6.10

Flojet Diaphragm Pump

Built-in pressure switch automatically starts and stops pump instantaneously.

- Can run dry without damage
- Excellent self-priming capability
- Low-current draw



Part No.	Old No	Flojet Model No.	Power	Max Flow	Max PSI	Ports	Diaphragm* Valves*
8.702-325.0	100879	2135-561	12V DC	1.48	60	3/8" FPT B	V
8.702-328.0	100884	4300-142A	12V DC	3.30	40	1/2" Barb S	E
8.702-312.0	100863	2100-032	115V	1.85	50	3/8" FPT S	S
8.702-337.0	100895	2100-022A	115V	1.85	50	3/8" FPT V	V
8.702-331.0	100888	4300-042	115V	3.70	35	1/2" Barb S	E
8.702-329.0	100884A	4300-043A	115V	4.70	35	1/2" Barb S	E

* B = Buna V = Viton E= EPDM S = Santoprene

NOTE: These units are designed to withstand many harsh chemicals. However, because compounds and concentrations of materials pumped through these units are beyond the manufacturer's control, the manufacturer DOES NOT PROVIDE A WARRANTY on the wet-end of the pump.

Diaphragm Pump Units

1.00-3.8 GPM integrated pump motor units. Powered by 12V DC or 115V AC power. Pumps are standard with Santoprene® diaphragms and Viton valves for excellent service with a wide variety of sprayable products.

NOTE: Flow is reduced as pressure is increased (i.e. 100850 pumps 1.12 GPM @ 60 PSI) Automatic demand control on/off.

- Chemical-resistant materials
- Self-priming
- Automatic demand pressure switch or internal bypass
- Can run dry without damage
- Low-Amp draw



Part No.	Old No	Shurflo Model No.	Power	Max Flow	Max PSI	Ports	Diaphragm*	Valves*
8.702-294.0	100841	8000-541-236	Demand	12V DC	1.0	60	3/8" FPT	S V
8.702-304.0	100854	8000-343-236	Demand	12V DC	1.2	60	3/8" FPT	V V
8.702-300.0	100850	8000-543-236	Demand	12V DC	1.8	60	3/8" FPT	S V
8.702-296.0	100844	8000-543-238	Demand	12V DC	1.4	100	3/8" FPT	S V
8.702-335.0	100893	8030-813-239	Demand	12V DC	1.5	150	3/8" FPT	S V
8.702-302.0	100852	8002-793-238	Demand	12V DC	1.7	100	3/8" FPT	S E
8.702-311.0	100862	8000-532-256	Demand	115V	1.0	60	3/8" FPT	S V
8.702-307.0	100857	8000-033-236	Demand	115V	1.0	60	3/8" FPT	V V
8.702-306.0	100856	8000-533-236	Demand	115V	1.4	60	3/8" FPT	S V
8.702-334.0	100892	8000-812-288	Bypass	115V	1.4	100	3/8" FPT	S V
8.702-308.0	100858	8000-813-238	Demand	115V	1.6	100	3/8" FPT	S V
8.702-338.0	100896	8000-713-238	Demand	115V	1.6	100	3/8" FPT	S E
2088 Premium Series – self-primers up to 12 foot – Built-in Back Check								
8.702-305.0	100855	2088-343-135	Demand	12V DC	3.0	50	1/2"-14M	S V
8.702-303.0	100853	2088-313-145	Demand	12V DC	3.6	50	1/2"-14M	S V
8.702-301.0	100851	2088-712-244	Demand	12V DC	3.8	50	1/2"-14M	S E
8.702-310.0	100861	2088-394-154	Demand	115V	3.2	40	1/2"-14M	S V
4111 – Double Head								
8.702-339.0	100899	4111-035	Demand	12V	7.0	50	1/2"-14M	S V
166 – Air Drive								
8.702-317.0	100870	166-200-56	Demand	AIR	2.0	60	3/8" Barb	E E
8.702-318.0	100871	166-200-36	Demand	AIR	2.0	60	3/8" Barb	V V

*S = Santoprene V = Viton E= EPDM

NOTE: These units are designed to withstand many harsh chemicals. However, because compounds and concentrations of materials pumped through these units are beyond the manufacturer's control, the manufacturer DOES NOT PROVIDE A WARRANTY on the wet-end of the pump.

Aquatec 550 Series Diaphragm Pump

These pumps can either be controlled by a pressure switch (“demand” mode) or an external power control device. When required, an integrated bypass can be incorporated to help regulate pressure levels.



- Powerful flow rates up to 5.5 GPM/21 LPM at pressures up to 80 PSI/5.5 Bar
- Patented 5-chamber diaphragm and piston design
- Quiet noise levels and with minimal pulsations



Part No.	Aquatec Model No.	GPM	Max Flow	Max PSI	Ports	Diaphragm* Valves*
8.750-812.0	25513-1E11-M63812V DC	5.3	60	1/2" NPT	S	E

Industrial Chemical Sprayer

Excellent pre-prep chemical applicator. Trigger control, demand flow, wall-mount cabinet, enclosed pump unit pulls chemical from a bulk tank and delivers it through 100' lightweight hose for low-pressure stream/cone or mist application. Operator simply squeezes trigger for instant application.



- Diaphragm pump units
- 60 PSI pressure
- Choice of 12V DC or 110V DC
- 100-foot hose
- Adjustable nozzle for cone mist to straight stream
- Durable Santoprene and Viton-wetted parts

Part No.	Old No	Description	Motor	PSI	GPM
Wall Mount / Cabinet Sprayer					
8.906-090.0	810020	Chem Applicator	115V AC	60	1.15
8.906-089.0	810010	Chem Applicator	12V DC	60	1.02

NOTE: These Units are designed to withstand many harsh chemicals. However, because compounds and concentrations of materials pumped through these units are beyond the manufacturer's control, the manufacturer DOES NOT PROVIDE A WARRANTY on the wet-end of the pump.

Trigger Valves

Versatile hand-held trigger valves for chemical or water-flow control.

- 1/2" FPT inlet/outlet
- Lock-on trigger loop
- 18.5 GPM
- 700 PSI



Part No	Old No	Description
Aluminum Body – SS/ BR Valve		
8.708-982.0	266652	Trigger Valve – Viton
Plastic body – SS/ BR Valve		
8.708-983.0	266658	Trigger Valve – Viton
8.708-984.0	266659	Trigger Valve – Buna

Spraymax Trigger Gun

For pest control applications.

- 1000 PSI
- 200° temperature
- Compare to JD-9, Mag-1, Robco and Ges
- Adjusts from fine mist to straight stream
- Drip-free shutoff
- Crafted for all-day comfortable use
- Larger trigger for 4-fingered grip



Part No	Old No	Description
8.708-995.0	266693	With 1/2" Inlet
8.709-028.0	268047	Repair Kit

Turbine Series Guns

Forged-brass housings, stainless-steel lances, mist cone to straight stream adjustment, on/off control, lock-on trigger, 1/2" MPT inlet Viton seals, up to 1200 PSI at 140°F.



- 1200 PSI
- 1/2" BSP male inlet
- Weighs only 4 lbs.
- Standard 15 x 1 LRT (4.5mm)
- 62 ft.-reach, straight stream @ 850 PSI
- 31.5 ft.-reach, full cone @ 850 PSI

Part No	Old No	Description	Length
8.708-990.0	266680	Long Range Turbine	27-1/2"
8.708-989.0	266676	Turbine	26-1/2"

Gun Assembly - 910 Spot Spray

High-pressure trigger gun adapted to spot spray application.

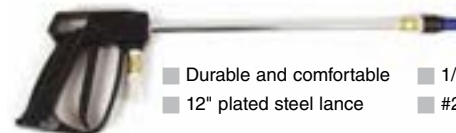

- Durable and comfortable
- 12" plated steel lance
- 1/4" hose barb inlet
- #2 blue adjustable nozzle

Part No	Old No	Description
8.904-088.0	352940	910 Spot Spray Gun Assembly

Trigger-Control Spray Lances

Excellent for low-pressure chemical applications up to 150 PSI. Available in either plastic- or brass-lance tube. Works well with neutral, alkaline or mild acid solutions.



- Steel trigger and service wrench
- Plastic valve body
- Brass-needle plunger
- Filter screen in nozzle housing
- Standard 11/16" outlet thread for standard low-pressure nozzle
- Cone nozzle adjusts 0-80°
- Accepts the adjustable cone nozzles or standard tip-jet nozzles (11/16 nozzle thread)
- 24" lance — brass or plastic

Part No.	Old No	Description
Trigger Lance		
8.902-777.0	266606	Brass w/o Nozzle
8.902-778.0	266607	Plastic w/o Nozzle
8.708-977.0	266603	Plastic w/ Red Nozzle
8.708-978.0	266610	Brass w/ Red Nozzle
8.700-493.0	076700	Needle Valve and Seal Kit

Part No.	Old No	Description	80° StraightCone
Adjustable Nozzle – GPM @ 40 PSI / Adjust 0-80°			
8.708-979.0	266611	#1 Yellow	.316 .156
8.708-980.0	266612	#2 Red	.545 .204
8.708-981.0	266613	#3 Blue	.720 .250

Brass Pressure Regulator

Durable and strong.

- 3/4" FPT outlet
- 120°F temperature
- 10.3 oz weight
- For sprayers pumping up to 15 GPM
- Adjustable pressure ranges
- Stainless-steel spring
- Tee-handle adjustment screw
- 3/4" MPT inlet
- Knurled locknut for ease of locking in adjustment



Part No	Old No	Description
8.712-557.0	462217	0-300 PSI
8.712-558.0	462218	300-700 PSI

Heavy-Duty Swivels

Live swivels help prevent twisted and tangled hose.

- Brass body and stainless-steel bolt
- Viton seals
- 600 PSI
- 1/2" MPT inlet and 1/2" outlet



8.708-996.0

Part No	Old No	Description
8.708-996.0	266700	Swivel 1/2" M x F
8.708-997.0	266701	Swivel 1/2" M x 3/4" FGH

Trigger-Jet Spray Lances

Low-pressure chemical application lance will tolerate mild acid solutions.



- Diaphragm shut-off valve
- Hand-grip trigger control
- Plastic lance tube resistant to acids and agricultural chemicals
- 150 PSI
- Excellent for mild acids or alkali chemicals
- Polypropylene body EPDM seals STD
- 11/16" — nozzle connect outlet

Part No	Old No	Description
Trigger Lance		
8.709-182.0	302250V	24" 1/4" FPT inlet, Viton
8.709-183.0	302251	24" 1/4" HB inlet, EPDM
8.709-184.0	302252V	3/8" Hose Barb, Viton
Trigger Valve Only		
8.709-185.0	302254V	3/8" HB Inlet/ 11/16" Outlet, Viton
8.709-186.0	302255V	1/4" HB Inlet/ 11/16" Outlet, Viton
8.709-187.0	302256V	1/4" FPT Inlet/ 11/16" Outlet, Viton
Parts and Accessories – Trigger Jet Lance		
8.709-188.0	302258	Adapter, 11/16" x 11/16" PP
8.709-189.0	302259	24" Lance Tube only
8.709-190.0	302260	24" Lance Tube w/ Seals and Fittings
Trigger Jet Nozzles – Polypropylene adjust from 0° to 60° Cone		
8.709-192.0	302263	Yellow Core(x 3), .23 GPM/ 60 PSI
8.709-193.0	302265	Green Core (x 5), .37 GPM/ 60 PSI
8.709-194.0	302266	Red Core (x 6), .45 GPM/ 60 PSI
8.709-195.0	302268	Gray Core (x 8), .57 GPM/ 60 PSI
8.709-196.0	302272	Brown Core (x 12), .84 GPM/ 60 PSI
8.709-197.0	302274	Orange Core (x 18), 1.2 GPM/ 60 PSI

Long Range Tip – 15 x 1 – Stainless-Steel

Best used with long-range turbine gun.



	Part No.	Old No	Orifice Dia (mm)
■ 15 x 1 long-range tip	8.708-998.0	266706	3.5
■ Stainless-steel body	8.708-999.0	266707	4.0
■ 850 PSI	8.709-000.0	266708	4.5
■ 24.4 GPM	8.709-001.0	266709	5.0
■ 77 ft. max throw range	8.709-002.0	266710	5.5
	8.709-003.0	266711	6.0
	8.709-004.0	266712	7.0

Low-Flow Brass Pressure Regulator

- For sprayers pumping up to 5 GPM
- Durable and strong brass construction
- Stainless-steel spring
- Positive Viton seal to prevent leakage
- Knurled locknut for easy adjustment
- 1/2" MPT inlet
- 1/2" FPT outlet
- 120°F temperature
- 10.3 oz weight



Part No	Old No	Description
8.712-553.0	462207	200-650 PSI
8.712-554.0	462208	0-300 PSI

Nylon Pressure Regulator

Maximum corrosion resistance.

- Male inlet/female outlet
- 120°F temperature
- 4 oz weight
- Built to handle up to 15 GPM
- Stainless-steel spring
- Positive Viton seal prevents leakage and provides the best chemical resistance
- Knurled locknut for ease of locking in adjustment
- Tee-handle adjustment screw
- Choice of 1/2" or 3/4" inlet/outlet



Part No.	Old No	Inlet	Outlet	Adjustable Pressure Range
8.712-555.0	462212	1/2"	3/4"	0-250 PSI
8.712-552.0	462202	3/4"	3/4"	0-250 PSI
8.712-556.0	462213	3/4"	3/4"	0-400 PSI

Bulkhead Fittings

- Black polypropylene
- Double-threaded with EPDM gasket
- Opening same size as outside diameter



Part No	Old No	FPT	Hole Dia
8.705-336.0	141232	1/2"	1-5/8"
8.705-338.0	141234	3/4"	1-5/8"
8.705-144.0	140430	3/4"	1-3/4"
8.705-145.0	140432	1"	1-3/4"
8.705-339.0	141236	1"	2-1/2"
8.705-341.0	141238	1-1/4"	2-1/2"
8.705-342.0	141240	1-1/2"	2-1/2"
8.705-146.0	140434	1-1/2"	3"
8.705-147.0	140436	2"	3"
8.705-343.0	141242	2"	3-1/8"
Gaskets for Above			
8.705-337.0	141233	Fits 1/2", 3/4"	
8.705-340.0	141237	Fits 1", 1-1/4", 1-1/2"	
8.705-344.0	141243	Fits 2"	

Brass Bulkhead / Tank Fittings

- Use to drain or remove liquids from tanks, drums, etc.
- Heavy-duty brass
- Includes nut and aluminum grip washer



Part No.	Old No	Overall Length	Mounting Hole Dia
8.705-139.0	140417	1/8" x 1.5"	5/8"
8.705-140.0	140419	1/4" x .94"	3/4"
8.705-141.0	140420	1/4" x 1.5"	3/4"
9.802-149.0	140421	3/8" x 1.3"	1"
9.802-150.0	140422	1/2" x 1.5"	1-1/8"

NOTE: Installation requires access to inside of tank.

Diaphragm Check Valves – Nylon

For drip-free spraying.

- 125 PSI
- 2 GPM
- 10 PSI opening pressure
- Nylon body, polypropylene end cap – EPDM – diaphragm
- 1/4" MPT inlet, 11/16" — 16 male outlet nozzle thread
- Spring-backed diaphragm for positive action



Part No	Old No	Description
8.709-377.0	310851	Diaphragm Check Valves

- DO NOT USE ... Polypropylene for: gasoline, nitric acid, trichlorethylene, toluene, aromatic hydrocarbons or kerosene. Polypropylene "P" — black/glass reinforced.
- DO NOT USE ... Nylon for: hydrochloric acid, chlorine, fluorine, nitric, xylene or phosphoric or sulfuric acids. Nylon 6/6 "N" white/tural color.

Twin-Diaphragm Spot Spray Pump

FLOJET

- 1 GPM (open)
- 35 PSI (#8 tip)
- 3/8" hose barb inlet/outlet
- Self-priming to 2.5 feet
- Operating temperature 40°-110°F
- Liquid temperature 110°F max
- 5 Amp fuse
- 1.3 lbs. dry weight
- Compact automatic on-demand operation
- Sealed pressure switch automatically stops pump when discharge valve opens and closes
- Self-priming so pump can be located above supply tank
- Can run dry for extended periods without damage
- Built-in thermal protection on 12V DC motor
- Low-Amp draw (2.5 @ 25 PSI, 4.0 @ 35 PSI)
- Chemical-resistant valves and diaphragm



Part No.	Old No	Description	Open Flow
8.702-326.0	100880	Spot Spray Pump, Max 35 PSI, 12 V DC	1.0

Plastic Fittings

For cater and chemical supply lines. Ideal for use with most alkaline-based detergents, most agricultural chemicals, ethanol, and most ammonium and sodium-based compounds.

■ 150 PSI

■ 140°F max @ 90 PSI

■ 90°F max @ 150 PSI



Part No	Old No	Description	Barb x MPT
Hose Barbs – Barb x MPT			
8.705-262.0	141077P	Poly	1/4" x 1/4"
8.705-264.0	141080P	Poly	1/4" x 3/8"
8.705-263.0	141078P	Poly	3/8" x 1/4"
8.705-265.0	141081P	Poly	3/8" x 3/8"
8.705-268.0	141084P	Poly	1/2" x 3/8"
8.705-270.0	141086P	Poly	5/8" x 1/2"
8.705-277.0	141102N	Nylon	1/4" x 1/4"
8.705-280.0	141105N	Nylon	1/4" x 3/8"
8.705-278.0	141103N	Nylon	3/8" x 1/4"
8.705-281.0	141106N	Nylon	3/8" x 3/8"
8.705-284.0	141110N	Nylon	3/8" x 1/2"
8.705-282.0	141107N	Nylon	1/2" x 3/8"
8.705-285.0	141111N	Nylon	1/2" x 1/2"
8.705-288.0	141117N	Nylon	1/2" x 3/4"
8.705-283.0	141108N	Nylon	5/8" x 3/8"
8.705-286.0	141112N	Nylon	5/8" x 1/2"
8.705-289.0	141118N	Nylon	5/8" x 3/4"
8.705-287.0	141113N	Nylon	3/4" x 1/2"
8.705-290.0	141119N	Nylon	3/4" x 3/4"
8.705-291.0	141120N	Nylon	1" x 3/4"
90° Barb x MPT Elbows			
8.705-293.0	141125P	Poly	1/4" x 1/4"
8.705-296.0	141130P	Poly	1/4" x 3/8"
8.705-294.0	141126P	Poly	3/8" x 1/4"
8.705-298.0	141131P	Poly	3/8" x 3/8"
8.705-301.0	141136P	Poly	3/8" x 1/2"
8.705-295.0	141127P	Poly	1/2" x 1/4"
8.705-299.0	141132P	Poly	1/2" x 3/8"
8.705-303.0	141137P	Poly	1/2" x 1/2"
8.705-307.0	141141P	Poly	1/2" x 3/4"
8.705-304.0	141138P	Poly	5/8" x 1/2"
8.705-308.0	141142P	Poly	5/8" x 3/4"
8.705-305.0	141139P	Poly	3/4" x 1/2"
8.705-310.0	141143P	Poly	3/4" x 3/4"
8.705-297.0	141131N	Nylon	3/8" x 3/8"
8.705-300.0	141136N	Nylon	3/8" x 1/2"
8.705-302.0	141137N	Nylon	1/2" x 1/2"
8.705-306.0	141141N	Nylon	1/2" x 3/4"
8.705-309.0	141143N	Nylon	3/4" x 3/4"

Part No	Old No	Description	Barb x MPT
HEX Nipple – MPT x MPT			
8.705-316.0	141184P	Poly	1/4" x 1/4"
8.705-317.0	141185P	Poly	3/8" x 3/8"
8.705-323.0	141190P	Poly	1/2" x 3/8"
8.705-319.0	141186P	Poly	1/2" x 1/2"
8.705-326.0	141193P	Poly	3/4" x 1/2"
8.705-321.0	141187P	Poly	3/4" x 3/4"
8.705-324.0	141191N	Nylon	1/2" x 1/4"
8.705-322.0	141190N	Nylon	1/2" x 3/8"
8.705-318.0	141186N	Nylon	1/2" x 1/2"
8.705-320.0	141187N	Nylon	3/4" x 3/4"
Elbows – Barb x Barb			
8.705-335.0	141216P	Poly	3/8" x 3/8"
Tees Barb x Barb x Barb			
8.705-329.0	141207P	Poly	1/2" BxBxB
8.705-332.0	141215P	Poly	3/4" BxBxB
8.705-327.0	141202N	Nylon	1/4" BxBxB
8.705-328.0	141205N	Nylon	3/8" BxBxB
8.705-334.0	141216N	Nylon	3/4" BxBxB
"Push-On" Hose Barbs – (Normally does not require clamps)			
8.705-346.0	141305N	Nylon	1/4" Bx1/4" FPT

Sprayers & Parts

Professional Stainless-Steel Sprayer

- Stainless-steel tank
- Brass wand
- Brass cap
- Brass handle
- Precise spray patterns (both straight stream and fan spray) from an all-brass tip
- Famous non-drip nozzle that professionals demand



Part No	Description
8.697-373.0	Pro Stainless-Steel Sprayer

Stainless-Steel Industrial Sprayer

2-gallon industrial sprayer.
Plastic valve and brass extensions, fan-spray tip.

- Heavy-duty stainless-steel tank
- Plastic valve with brass extension
- Chemical-resistant seals
- Available in 2- and 3-gallon capacities
- Plastic pin-to-cone spray tip
- Funnel top design



Part No	Description
8.697-170.0	Stainless-Steel Industrial Sprayer

Stainless-Steel Sprayer

2-gallon sprayer with plastic valve and extension.
Adjustable pin-to-cone tip.

- Heavy-duty stainless-steel tank
- Chemical-resistant hose
- Plastic valve and extension
- Buna-N seals and gaskets
- Pin-to-cone adjustable spray tip
- 2-gallon capacity
- Economically priced but durable



Part No	Description
8.697-169.0	Stainless-Steel Sprayer

Sprayermaster – High-Pressure

5-quart high-pressure Spraymaster.

- 4-1 or 9-1 dilution ratio



Part No	Description
8.697-413.0	Sprayermaster High-Pressure

Sprayer – Chemical-Resistant

Large funnel top, poly-molded, chemical-resistant.

- Heavy-duty polyethylene tank
- Wide base for extra stability
- Durable brass valve and extension
- Chemical-resistant seals
- Reinforced chemical-resistant hose
- Celcon fan spray tip
- Brass spray gun



Part No	Description
8.697-165.0	Sprayer Chemical Resistant – 1 gallon
8.697-168.0	Sprayer Chemical Resistant – 2 gallon
8.697-171.0	Sprayer Chemical Resistant – 3 gallon

Poly-Molded Sprayer

3-gallon poly-molded sprayer with maximum chemical resistance.

- Heavy-duty design, economical price
- Blue poly-molded tank
- Funnel top design for ease-of-filling
- Durable plastic valve and extension
- Pin-to-cone spray tip Fully repairable
- Braided, reinforced hose
- Optional flat-fan spray tips available
- Buna gaskets and seals



Part No	Description
8.697-172.0	Poly-Molded Sprayer

Foam Nozzle Attachment

Foaming nozzle attachment fits: Stainless and hand-held sprayers.



Part No	Description
8.697-164.0	Foam Nozzle Attachment

Sprayermaster – Standard

7-quart standard Spraymaster.

- 9-1 complete
- Includes swivel quick disconnects
- T-jet / check valve



Part No	Description
8.697-412.0	Sprayermaster Standard

Tile & Hard Surface Tools

Hard-Surface Spinner Tool

Professional-grade, hard-surface spinner tool.

- All stainless-steel construction
- Vacuum hose inlet fits either 1.5" or 2" hose
- Angled nozzles, splashguard, high-pressure double-bearing and ceramic-seal assembly ensures professional results.



Part No	Description
8.697-376.0	Hard-Surface Spinner Tool

Van Accessories

Solution Hose Live Swivel Assembly

Turns your solution reel live for direct hookup.

- High-pressure
- 1/4" hose



Part No	Description
8.697-344.0	Solution Hose Live Swivel Assbly

Restoration Equipment & Accessories

Waterproof ExStik pH Meter

- 1-, 2- or 3-point calibration automatically recognizes buffer solutions
- Automatic temperature compensation simultaneous display of pH and temperature
- Display indicates when the reading is stabilized
- Data Hold, Auto Power-Off and low-battery indication
- Waterproof design floats in water and protects the meter in wet environment
- Interchangeable probes available for Chlorine and ORP
- Optional weighted base holds Head diameter: 3.375" or 55 mm
- Body diameter: 1.5" or 38 mm
- Length: 12" or 254 mm plastic cup and ExStik® meter



Part No	Description
8.697-330.0	Waterproof ExStik pH meter

Sonin Digital Moisture Meter

- Measures moisture levels from 5 to 40%, resolution 1%
- Easy-to-read, large LCD display with low-battery symbol
- Date-hold function
- Replacement probe included
- Protective carrying pouch included



Part No	Description
8.750-460.0	Sonin Digital Moisture Meter

UV Flashlight Blaze 128 LED

128 Individual LED UV Flashlight.

The Blaze-XL128 flashlight offers an amazing 128 individual LEDs which makes it the largest LED flashlight on the market. Unlike the higher wave length 400 nM versions that come with a strong visible purple light and a hefty price tag, this one puts out less visible light making inspections more accurate and easier. All of this packed in a lightweight aluminum body weighing just 22 ounces.

- Bulb type: 390 to 395 (nM)
- Bulb life: 100,000 hours
- Head diameter: 3.375" or 55 mm
- Body diameter: 1.5" or 38 mm
- Length: 12" or 254 mm
- Body material: Aluminum with "O" rings for water resistance
- Battery require: 3 x D size alkaline battery (not included)
- Battery life: Approximately 40 hours on three D-size batteries
- Switch type: Click on/Click off
- Weight: 1.5 LB (without batteries)



Part No	Description
8.697-331.0	UV Flashlight 128 LED Blaze

Sonin 4-in-1 Multifunction Detector

4-1-1 stud, moisture, metal, and voltage detector.

- Detects moisture percentages 8%-22%
- Helps find if potentially damaging excess moisture is present
- Locate and trace water leaks to prevent wet rot
- Detects wood and metal studs, beams and joists behind walls up to 3/4" deep
- Non-contact voltage detection helps you trace and locate live AC wire behind walls, ceilings, up to 2" deep
- Detects -ils in wood up to 2" deep
- Detect and locate hidden metal, steel and copper pipes, and frames (both ferrous and nonferrous) behind walls up to 2" deep
- Fast, accurate and easy-to-read LED display with audible indicator
- Microprocessor-based instrument with automatic calibration to ensure accuracy
- Low-battery warning
- Requires one 9V battery (not included)
- One-year warranty



Part No	Description
8.697-029.0	Sonin 4-in-1 Multifunction Detector

Extech pH Meter Buffer Solution

Calibrating buffer solution.



Part No	Description
8.697-395.0	Buffer Solution – pH 10
8.697-397.0	Buffer Solution – pH 7
8.697-396.0	Buffer Solution – pH 4

Sonin Laser Targeting Range Finder

Take the guesswork out of ultrasonic-distance measuring by pinpointing the approximate center of your target area.

- Adds linear measurements, area, volumes
- Measures in Ft/In, M/Cm, Decimal Ft. and Yds.
- Tracking and validate modes
- Can measure from top or bottom of unit
- Seven memories with easy recall
- Automatic internal temperature compensation
- Auto shut-off seven minutes after last use
- Multi-lingual detailed instruction booklet
- Low-battery warning
- Requires one 9V battery (not included)
- Accuracy 99.5% +/- 1/4" (1cm)
- Protective pouch with belt loop
- Recommended for indoor-use only
- One-year warranty



Part No	Description
8.697-036.0	Sonin Laser Targeting Range Finder

Sonin Moisture Test Meter

Dual-reading scale gives relative (1-10) and moisture percentages 10-28% readings.

- Instruction sheet included
- One-year warranty
- Helps you to select drier lumber
- Contact probes are on a 3'-coiled cable for detecting moisture in hard to reach spots
- The 10-point scale corresponds to moisture levels from 10-28%
- Scale and reference chart correlate relative and moisture percentage readings
- Great for inspectors, contactors and homeowners
- Test hard or soft wood, concrete, plaster, carpet and more to determine the extent of moisture problems
- Find out if potentially damaging excess moisture is present
- Locate and trace roof leaks and water seepage; assess the extent of wet rot and hidden condensation
- Use it to check surfaces before painting, wallpapering or laying floors or tile
- Requires one 9V battery (not included)



Part No	Description
8.697-031.0	Sonin Moisture Test Meter

Sonin Multi-Measure 45

Easy-to-use tapeless distance-measuring tool. Get the entire square footage of a house in only minutes.

- Measures from 1'10" up to 45 feet (13 meters)
- Displays measurements to the 1/4"
- Computes areas and volumes
- Adds linear measurements, area, volumes
- Measures in Ft/In, M/Cm
- Tracking and Validate modes
- Automatic internal temperature compensation
- Auto shut-off seven minutes after last use
- Multi-lingual detailed instruction booklet
- Multi-lingual quick-reference instruction label
- Low-battery warning
- Requires one 9V battery (not included)
- Accuracy 99.5% +/- 1/4" (1cm)
- Recommended for indoor-use only
- One-year warranty



Part No	Description
8.697-037.0	Sonin Multi-Measure 45

Ozone Generator Villa 1000

Eliminate odors naturally.

The odor-free purifier will oxidize unwanted odors in your facility. It generates O3, or ozone, which disbursts into the space to be treated. The O3 attacks odors at their source and sanitizes the entire treatment area. It is especially effective on:

- Cigarette smoke
- Mold and mildew
- Smoke damage
- Food odors
- Pet odors
- Carpet odors
- Water damage
- Cleaning fumes
- Beverage odors
- Decaying matter
- New construction
- Microorganisms



Part No	Description
8.697-128.0	Ozone Generator Villa 1000

Moisture Sensor, Hydro Shark

- 31" long
- Reads moisture content of 17%
- For use in urine detection and moisture mapping



Part No	Description
8.697-417.0	Moisture Sensor, Hydro Shark

Carbon, Vapor Lock Filter

Third-stage, vapor-lock carbon filter.

- Third-stage, 2" high-capacity, carbon, vapor-lock filter
- The third-stage filter has woven carbon media for absorption of gases and odors
- It is recommended you change the third-stage filter every six to 12 months under normal operating conditions



Part No	Description
8.697-390.0	Carbon, Vapor Lock Filter

Second-Stage Particulate Filter

2" second-stage, pleated particulate filter.

- Second-stage, pleated particulate filter
- Removes more finer particulates than the first-stage filter
- It is recommended you change the second-stage filter every six to nine months under normal operating conditions



Part No	Description
8.697-389.0	Carbon, Vapor Lock Filter

Fiber Trapper Pre-Filter

Particulate pre-filter for air filtration units used for commercial, industrial, residential, and healthcare applications.

The FiberTrap pre-filter is designed to capture the coarsest particles circulating through your air duct system which helps to extend the life of the second-stage carbon-pleated filter and the HEPA filter, saving you money!



Part No	Description
8.697-386.0	Fiber Trapper Pre-Filter

HEPA Filter PRED 1200

Fi-I-stage, round High-Efficiency Particulate Arresting (HEPA) filter.

- Fi-I-stage, round replacement HEPA filter
- HEPA filters capture 99.97% of airborne contaminants as small as 0.3 microns in size
- The H610C-99 removes bacteria, mold spores, soot, pollens, animal hair, animal dander, dust mites, smoke particles and other allergens and lung damaging particles
- It is recommended you change the final filter every two to three years under normal operating conditions



Part No	Description
8.697-383.0	HEPA Filter PRED 1200

Predator 1200 Portable Air Scrubber

The new, state-of-the-art rotational-molded HEPA filtration systems.



- High-density polyethylene cabinet is strong and durable; resin includes microbial growth and UV inhibitors
- Powerful — provides more airflow per pound than other products
- Lightweight (70 lbs) and portable, superior mobility for vehicle loading / unloading and easyrolling to the job site
- Low-ampere draw, safely 'daisy-chain' up to three units on one 115V / 15-Amp circuit
- True 99.97% HEPA filtration, Type A HEPA tested and certified to IEST construction and testing standards; microglass media does not rely on an electrostatic charge to maintain efficiency; two pre-filter stages; optional third stage
- Economical to operate

Part No	Description
8.697-384.0	Predator 1200 Portable Air Scrubber

Predator 600 Portable Air Scrubber

The world's lightest and smallest PAS with the performance and features you need.



- INCREDIBLY LIGHTWEIGHT AND COMPACT – Weighs just 34 lbs. including filters — about 10 pounds lighter than any other PAS
- POWERFUL – Variable-speed airflow, rated at 200 to 600 cfm. PRED 600 is the smallest 600 cfm unit on the market
- SPECIAL CABINET RESIN – Cabinets made from a high-density polyethylene resin that contains microbial growth and UV inhibitors. And, the Tefgard™ finish is easy to clean and decontaminate
- EFFECTIVE FILTRATION – Comes with two pre-filters and a true 99.97% HEPA filter. Vapor-Lock® carbon pre-filter is optional
- ECONOMICAL TO OPERATE – Filters last longer and cost less — you can save hundreds of dollars in replacement filter costs
- SECURE STACKING – Multiple units nest securely together to save space when stacked in a warehouse, a van, or on the job. They can even run when stacked
- LOW-AMPERAGE DRAW, – Up to five units can be safely daisy-chained on one 15-Amp circuit (total current draw 12 Amps).

Part No	Description
8.697-385.0	Predator 600 Portable Air Scrubber

ZipWall 12' Poles – 2/pk

Two spring-loaded poles, extends from 4'-7" to 12', includes two sets of parts (head, plate, tether, GripDisk™).



- The six SLP™ poles extend from 4'-9" to 12'
- The poles can be placed 8 to 10 feet apart. If there is any significant air movement that pushes the plastic, you will want to pull them in closer together
- The GripDisk™ slide stoppers should always be used, especially on hard surfaces
- Six GripDisk™ slide stoppers come in every package

Part No	Description
8.697-368.0	ZipWall 12' Poles 2/pk

ZipWall Carrier Bag

Sturdy, durable. Can hold 12 SLPs or six 20' poles with jacks unattached.



- Made of tough polyester
- Keeps all your barrier products organized and easy to transport
- Holds the 20 foot pole and the red jack u-ttached

Part No	Description
8.697-366.0	ZipWall Carrier Bag

ZipWall Side Clamp – 2/pk

Two side-clamp wall mounts.



- Each side-clamp wall mount is made of polycarbonate and is very tough
- This product can easily fit into the ZiWall® carry bag with poles and Foam Rail™ cross bars
- In some situations where you have large crown moldings and base board heat on the same wall, the pole may be too far from the wall for the side-clamp wall mounts to reach

Part No	Description
8.697-365.0	ZipWall Side Clamp 2/pk

Duckbill Snipping Shears

Unique duckbill blade designed for precision cuts. 7"

- Offset handle for easy-level nap trimming.



Part No	Description
8.697-060.0	Duckbill Napping Shears (7")

ZipWall Zipper

Includes two self-adhesive zippers and two cords for tying up a plastic flap. For indoor-use only.

- Makes an easy doorway through plastic barriers
- Designed by the manufacturers of the award-winning ZipWall® dust barrier systems
- Has the smoothest glide available
- Is engineered with large, sturdy easy-slide teeth
- Is made with two-sided pulls for easy entry / exit to or from the barrier
- Works best in temperatures above 55°F



Part No	Description
8.697-363.0	ZipWall Zipper

Pressurized Drying System-21

Viking's new patent-pending pressurized drying system makes drying wall cavities easier and less frustrating than before.

Perfect for under sinks, behind cabinets and permanent furniture. Its portability makes drying a breeze. All-in-one containment provides the operator with simple on-the-go equipment. Just bore a 1/2" hole, plug in the end hose and begin drying. An on-board plug-off system makes plugging unused tubes simple.



Part No	Description
8.697-129.0	Pressurized Drying System-21

Legacy Air Mover (LAM3)

Legacy

Powerful up to 3000 CFM, lightweight, versatile three-speed air mover reduces carpet drying times by up to 50%.

- Durable polyethylene gray housing with a sturdy four-point motor mount
- Easy to carry and move. Lightweight with a balanced offset handle
- 120V AC, 60hz, 9 Amp, with molded cord hooks for storing the 25' 16/3
- 1/2 HP thermally protected continuous duty motor with capacitor start and four-point mount
- Built-in carpet clip makes it easy to dry floors under carpet — ideal for restoration work



Part No	Description
1.004-014.0	Legacy Air Mover

Air King Pivoting High-Velocity

The Pivoting Blowers are a perfect fit for any job site. The compact size makes them a great fit where space is tight.

- The Pivoting High-Velocity Blower features a pivoting head to direct air flow where you need
- With a type SO, GFCI power cord with test and reset buttons
- The 1/13 HP blower delivers just the amount of air flow you need
- Dimensions: 13"L x 11"W x 14.5"
Weight: 12.75 lbs.



Part No	Description
8.697-205.0	Air King Pivoting High-Velocity

Carpet Installation & Repair

Carpet Shears Bent Handle

Shears made for the most demanding of jobs.

- Entirely made in the U.S.A.
- Shears are hot-hammer-forged of high-integrity cutlery steel
- Hardened and tempered for durability and long life
- Shears are plated for superior protection against rust and corrosion
- Unconditional lifetime warranty against defective materials or workmanship
- A fully-warranted factory reconditioning is available for a charge for the life of the shears



Part No	Description
8.697-016.0	Carpet Shears Bent Handle (10")
8.697-017.0	Carpet Shears Bent Handle (8")

Aviation Snips for Most Metals

A high-quality, imported 10" snips with alloy steel handles.

- Alloy steel handles
- Hot-forged molybdenum steel blades
- Makes straight cuts 1-1/2" long in metal up to 18 gauge (.049") thick
- Vinyl grips for comfort



Part No	Description
8.697-068.0	Aviation Snips

Carpet Repair Replacement Blades

- Replacement blades for the Cookie Cutter Repair Tool
- 10 per pack



Part No	Description
8.697-340.0	Carpet Repair Replacement Blades

EZ Moves Pro

Set of four

- Used by moving men, carpet installers, carpet cleaners, painters, remodelers, store owners, janitorial services, interior designers and more



11.5" x 6.75"

Part No	Description
8.697-027.0	EZ Moves Pro

EZ Moves Hard Surface Pro

For heavy moving on hard floors (4/pkg).

- An accessory for your EZ Moves II™ to provide extra protection when moving items across hard surfaces



5-3/4" x 9-1/2"

Part No	Description
8.697-026.0	EZ Moves Hard Surface Pro

Instant Hold Replacement Disks

Replacement disks for the cookie-cutter repair tool.

- A must-have for the carpet repair professional
- 100 disks per pack



Part No	Description
8.697-343.0	Instant Hold Replacement Disks

Perfect Patch

Easiest way to repair carpet.

- The 3-in-1 Perfect Patch tool is the easiest way to repair carpet and it comes with a FREE how-to-patch a carpet video!



Part No	Description
8.697-392.0	White Chalk

Hoses, Connectors and Accessories

Ball Shut-Off Valve 1/4"

Replacement Econo shut-off valve.

- Use this ball valve on your solution hose
- Fits 1/4" fittings



Part No	Description
8.697-347.0	Ball Shut-Off Valve 1/4"

Premium Ball Shut-Off Valve

Replacement shut-off ball valve.

- Premium quality built into this shut-off valve



Part No	Description
8.697-125.0	Premium Ball Shut-Off Valve (1/4")

Chrome Ball Valve

- 1000 PSI
- 300° M/F
- "T"-handle valve



Part No	Description
8.697-414.0	Chrome Ball Valve – 1/4"

Connector 1.5"-2" Stainless-Steel

Durable stainless-steel vacuum hose connector.

- Connects 2" vacuum hose cuff to 1.5" hose cuff



Part No	Description
8.697-076.0	Connector 1.5"-2" Stainless-Steel

Connector 1.5" Stainless-Steel

Durable stainless-steel vacuum hose connectors for connecting two lengths of 1.5" vacuum hose.

- Connects two sections of 1.5" vacuum hose



Part No	Description
8.697-075.0	Connector 1.5" Stainless-Steel

Connector 2" Stainless-Steel

Durable stainless-steel vacuum hose connectors for connecting two lengths of 2" vacuum hose.



Part No	Description
8.697-078.0	Connector 2" Stainless-Steel

Connector 2" Stainless-Steel 'Y' Vac

Vacuum hose "Y" — 2" stainless-steel hose connector.

- Use two wands on a single-wand machine
- Durable stainless-steel for long wear



Part No	Description
8.697-123.0	Connector 2" Stainless-Steel 'Y' Vac

Connector: Barb Hose 2"-1.5"

1.5" barb x 2" barb.



Part No	Description
8.697-348.0	Connector: Barb Hose 2"-1.5"

Connector: Barb Hose 1.5"-1.5"

1.5" barb x 1.5" barb connector.



Part No	Description
8.697-345.0	Connector: Barb Hose 1.5"-1.5"

Connector: Barb Hose 2"-2"

2" barb x 2" barb connector.



Part No	Description
8.697-346.0	Connector: Barb Hose 2"-2"

Coupler: 1/4" Female, Secure Lock



Part No	Description
8.697-085.0	Coupler: 1/4" Female, Secure Lock

Coupler: 1/4" Female

Parker quick-connect.



Part No	Description
8.697-079.0	Coupler: 1/4" Female

Coupler: 1/4" Female Stainless-Steel

Durable stainless-steel female replacement coupler.



Part No	Description
8.697-087.0	Coupler: 1/4" Female Stainless-Steel

Coupler: Quick Connect 1/4" F Econo

Female 1/4" econo replacement QD.

- Interchangeable with other manufacturers' fittings



Part No	Description
8.697-350.0	Coupler: Quick Connect 1/4" F Econo

Coupler: 1/4" Male Quick-Connect Econo

Coupler 1/4" male quick-connect, economy.

- Directly interchangeable with your worn out brass or stainless-steel couplers



Part No	Description
8.697-080.0	Coupler: Quick-Connect 1/4" M Econo

Coupler: 1/4" Male Stainless-Steel

Parker Hannifin coupler 1/4" male quick-connect.



Part No	Description
8.697-086.0	Coupler: 1/4" Male Stainless-Steel

Coupler: 1/4" Male Quick Connect PH

High-quality, long-life Parker Hannifin brand coupler.



Part No	Description
8.697-081.0	Coupler: 1/4" Male QC PH

Hide-A-Hose Swivel Cuff

Vinyl hide-a-hose swivel cuff.

- Now you can hide your solution hose within the vacuum hose line, and you can forget the hassles of trying to work with separate hoses lying all around!



Part No	Description
8.697-351.0	Hide-A-Hose Swivel Cuff (2")
8.697-349.0	Hide-A-Hose Swivel Cuff (1.5")

Swivel Cuff: Big End Threaded



Part No	Description
8.708-903.0	Big End Threaded (1.5")
8.708-904.0	Big End Threaded (2")
8.708-905.0	Swivel Cuff (1.5")
8.708-906.0	Swivel Cuff (2")

Hose Cuff 1.5"-2" Small End Threaded

Vinyl enlarger.

- 1-1/2" vinyl screw cuff enlarged to accommodate
- 2" O.D. wand connection



Part No	Description
8.697-091.0	Hose Cuff 1.5"-2" Small End Threaded

Hose Cuff 2" Swivel Reducer

2" vinyl swivel reducer cuff.



Part No	Description
8.697-093.0	Hose Cuff 2" Swivel Reducer

Hose Cuff 2"-1.5" Both Ends Threaded

2"-1.5" vinyl double threaded connector.



Part No	Description
8.697-095.0	Hose Cuff 2"-1.5" BET

Misc. Hose Cuffs and Accessories

Part No	Description
8.708-896.0	Hose Connector 1.5"-1.5"
8.708-900.0	Hose Cuff 2" Threaded Reducer
8.708-898.0	Hose Cuff 2"-2" Both Ends Threaded

Hose Hook 1.5

Hose Hook 1.5" to 3".



- Hook: 1/4" dia., 1-1/4" radius bend (2-1/2" opening)
- Coated to prevent scratches
- Can hook on larger objects
- Fits 1-1/2" to over 3" hoses

Part No	Description
8.697-100.0	Hose Hook 1.5

Hose Hugger 3 x 27

3 x 27" for 25' + of 1-1/2" vacuum hoses.



Part No	Description
8.697-122.0	Hose Hugger 3 x 27

Hose Hugger 3 x 34

3 x 34" for larger diameter vacuum hoses.



Part No	Description
8.697-121.0	Hose Hugger 3 x 34

Cord Hugger 3 x 12

For light-duty electric cords up to 100'.

- Clear the clutter and tangles with this handy accessory.



Part No	Description
8.697-120.0	Cord Hugger 3 x 12

D-Ring Handi Tie 1.5

An all-purpose tie for power cords and solution hoses. Keeps them with the tool or appliance.



Part No	Description
8.697-099.0	D-Ring Handi Tie 1.5

QD Connector Sleeve Set

To protect you and your customers.

- Covers the hot metal ends of your hose to prevent burns and damage to you and your customer
- Helps to protect brass fittings for longer life



Part No	Description
8.697-077.0	QD Connector Sleeve Set

Snap N Lock Cuff

Snap N Lock hose connector set.

- Stainless-steel button locks
- Positive locked connection
- High-impact, safety-yellow plastic
- Durable in hot or cold climates
- Fracture-resistant



Part No	Description
8.697-408.0	S-p N Lock Cuff (1.5"-1.5")
8.697-410.0	S-p N Lock Cuff (2"-1.5")
8.697-407.0	S-p N Lock Cuff (2"-2")

Snap N Lock Cuff 2"

Snap N Lock 2" leaf trap adapter.

- Stainless-steel button locks
- Positive locked connection
- High-impact, safety-yellow plastic
- Durable in hot or cold climates
- Fracture resistant



Part No	Description
8.697-409.0	Snap N Lock Cuff 2"

Tandem Hose Clamp

For keeping hoses connected.

- Tandem hose clamp 2" wide strap
- Adjustable



Part No	Description
8.697-101.0	Tandem Hose Clamp

Solution Hose Reel

Solution reels provide convenient storage for high-pressure solution hose and garden hose.



- Will accommodate up to 150' of 5/8" garden hose or 450' for 1/4" high-pressure hose
- Standard solution reels come in two sizes and come equipped with an angle bracket that bolts directly on to our vacuum hose reels
- All welded-steel construction with rust-resistant paint finish make it an attractive asset to any truck-mounted cleaning system

Part No	Description
8.697-071.0	Solution Hose Reel (150' 5/8", 450' 1/4")
8.697-070.0	Solution Hose Reel (100' 5/8", 300' 1/4")

Solution Hose 50', 1/4" 3000 PSI

High-temperature, high-pressure solution hose.

- 50 feet, steel-braided
- Handles up to 250°F and 3,000 PSI
- Tight-bend radius capability
- 1/4" male swage fittings and a black poly heat shield



Part No	Description
8.918-062.0	Solution Hose – Blue

Solution Hose 50', 1/4" 1500 PSI

High-temperature, high-pressure solution hose.

- 50 feet, gray, steel-braided
- Handles up to 250°F and 1,500 PSI
- Tight-bend radius capability
- 1/4" male swage fittings and a black poly heat shield



Part No	Description
8.918-074.0	Solution Hose – Blue
8.918-063.0	Solution Hose – Gray

Solution Hose 50', 3/8" Blue, 3000 PSI

High-temperature, high-pressure solution hose.

- 50 feet of 3/8" Goodyear high-pressure solution line, steel-braided
- For pressure washing or other equipment that requires more water flow
- 3000 PSI / 250°F
- Plastic heat sleeve



Part No	Description
8.739-148.0	Solution Hose – Blue

Truck-Mount Hose, Heavy-Duty Gray

Hose, 25' or 50' heavy-duty, truck-mount vacuum hose, gray with cuffs.

- The Combination of co-polymer materials and two-part helically-wound construction make this hose superior to others in the market
- Pro-Flex™ has all the characteristics users look for in a vacuum hose plus many added features such as ultraviolet protection, crush-resistance, smooth bore and much more.



Part No	Description
8.697-114.0	Truck-Mount Vacuum Hose (50', 1.5")
8.697-118.0	Truck-Mount Vacuum Hose (50', 2")

Truck-Mount Hose, Heavy-Duty Blue

Hose, 25' or 50' heavy-duty, truck-mount vacuum hose, blue with cuffs.

- The combination of co-polymer materials and two-part helically-wound construction make this hose superior to others in the market
- Pro-Flex™ has all the characteristics users look for in a vacuum hose plus many added features such as ultraviolet protection, crush resistance, smooth bore and much more



Part No	Description
8.697-112.0	Truck-Mount Vacuum Hose (50', 1.5")
8.697-117.0	Truck-Mount Vacuum Hose (50', 2")

Vacuum Hose Shelf Hook

4.5" vacuum hose shelf hook.

- For straight-sided shelves 4-1/4", plated to prevent rust



Part No	Description
8.697-102.0	Vacuum Hose Shelf Hook

Vacuum Hose Reel

These storage reels offer the advantage of using a reel as an effective piece of operating equipment rather than a simple device for the storage of hose.

- All storage reels feature custom-fabricated UHMW bearings. UHMW is a plastic compound that will provide trouble-free service
- All reels are pre-drilled to accept our solution reels which are simply bolted on
- All reels are equipped with a positive spool stop
- All reels are welded-steel construction and finished with rust-resistant paint



Part No	Description
8.697-072.0	Vacuum Hose Reel – 200'
8.697-073.0	Vacuum Hose Reel – 250'
8.697-074.0	Vacuum Hose Reel – 300'

Vinyl-Coated Wand Hook

- 2-1/2" wand / utility hook for chemical shelves
- Vinyl-coated to avoid scratching and rust



Part No	Description
8.697-103.0	Vinyl-Coated Wand Hook

Faucet Kit Adapter

- Universal faucet adapter



Part No	Description
8.697-406.0	Faucet Kit Adapter

Double Hose Reel Stand

Self-supporting, dual hose reel stand.

- Dual stand
- Self-supporting
- Provides more hose capacity than the single stand
- Also permits independent live operation of the reels



Part No	Description
8.697-419.0	Double Hose Reel Stand

Hose Reel Stand

Self-supporting, hose reel stand.

- Single stand
- Self-supporting
- Can be used to make reel portable or to simplify installation
- Also accommodates live operation of the reel



Part No	Description
8.697-420.0	Hose Reel Stand

Stack Bracket

Stack bracket for solution hose.

- Mounts to either side of vacuum storage reel
- Stack bracket will not add to the overall dimensions of the vac reel
- Allow space-saving convenience of double stacking two solution reels on same side of the vacuum reel



Part No	Description
8.697-421.0	Stack Bracket

Swivel Assembly

Convert standard solution reel to live storage

- 3/8" swivel
- 3/8" hose
- Fittings to attach hose



Part No	Description
8.697-423.0	Swivel Assembly

Brushes

Swivel Grout Brush

Swivel grout brush 1" X 8".

- The fibers on this brush are trimmed to a chisel edge to allow the brush to scrub aggressively along grout lines
- The stiff black fiber will stand up to tough use
- Uses standard-threaded handle (not included)



Part No	Description
8.697-287.0	Swivel Grout Brush

Nap Brush

Nylon, white, stiff -pping brush.

- Used to remove swirl marks from the rotary action of machines, foot prints, or even wheel tracks from equipment
- Shade the nap in one direction to give the carpet a neat, finished appearance
- Featherweight brush is 19" wide with three rows of 1-1/2" long nylon bristles
- Designed to not streak
- Nap brush is very strong, yet lightweight, which eliminates job fatigue and helps the job go faster



Part No	Description
8.697-320.0	-p Brush

Groomers

Grandi Brush

Designed to give maximum penetration on commercial-grade level and multi-loop carpets.

- The Grandi Brush features a single row of nylon fibers that have been designed to give maximum penetration on commercial-grade level and multi-loop carpets
- You can agitate pre-sprays as well as protectors to get optimum performance from your carpet cleaning chemicals



Part No	Description
8.697-009.0	Grandi Brush

Grandi Brush (Head Only)

No Handle.



Part No	Description
8.697-011.0	Grandi Brush (Head only)

Grandi Groom

Perfect for multi-level carpet pile.

- 18" wide head
- Ideal for agitating pre-spray into the carpet
- Excellent for working protector into the carpet



Part No	Description
8.697-012.0	Grandi Groom

Grandi Groom (Head Only)

No handle.



Part No	Description
8.697-019.0	Grandi Groom (Head only)

Handi Brush

This short soft bristle brush is excellent for upholstery, velvet, oriental rugs or any other fine fabric.

- Use before cleaning to lift nap and remove lint, pet hair or other debris
- Use after cleaning to lift nap



Part No	Description
8.697-014.0	Handi Brush

Grandi Groom Conversion

Convert your Grandi Groom to include the Grandi Brush head.



- The Grandi-Groom Conversion Kit consists of the Grandi Brush head with dual-head connector to attach to your existing Grandi Groom to create a two-headed grooming tool
- The Grandi Brush features a single row of nylon fibers that have been designed specifically to give maximum penetration on commercial grade level and multi-loop carpets
- You can agitate pre-sprays as well as protectors to get optimum performance from your carpet cleaning chemicals
- The Grandi Brush can be combined with the classic Grandi Groom to create the Grandi / Brush Combo
- With the conversion kit, you can create a two-headed grooming tool that adapts easily to any type of carpet

Part No	Description
8.697-013.0	Grandi Groom Conversion

Handi Groom Brush

Plastic bristles agitate pre-spray and protectants on stairs and hard-to-reach areas. Ideal for use in spot dyeing.

- Lightweight plastic bristle hand brush designed as a pile conditioner for carpeting on stairs and in tight places
- Excellent for restoring the appearance and texture of high-pile area rugs, fringes, even sweaters
- Compact and handy, but strong enough for stubborn dirt



Part No	Description
8.697-015.0	Handi Groom Brush

Containers

Measuring Cups

End the guessing game.

- Cups are calibrated for exact measurements



Part No	Description
8.697-021.0	Measuring Cups – 16 oz
8.697-024.0	Measuring Cups – 8 oz
8.697-023.0	Measuring Cups – 4 oz

Measuring Cups – 2 oz



Part No	Description
8.697-022.0	Measuring Cup – 2 oz

Spotting Bottle

Plastic spotting bottle with lid.



- Sprayer bottles and sprayers are perfect for chemicals and cleaners.

Part No	Description
8.697-006.0	Spotting Bottle – 32 oz
8.697-035.0	Spotting Bottle – 16 oz
8.697-007.0	Spotting Bottle – 4 oz

Misc. Accessories

Wall Buddy

The ultimate solution in corner protection.

- Can be used in the carpet cleaning-, janitorial- and painting-industries
- Protects all of the corners of the walls and furniture on your job
- Portrays a professional image which reassures your customer that you care
- Protects against costly insurance claims due to damaged corners or walls
- Made from a lightweight, non-marking durable plastic
- Can be sold to customers who have central vacuum systems



Part No	Description
8.697-425.0	EZ Fill Container

Drum Pump

Siphon drum pump.

- Made from polyethylene
- Fits 15-, 30- and 55-gallon drum with 2" National pipe thread



Part No	Description
8.704-696.0	Drum Pump

Styrofoam Blocks – White

White styrofoam, 2.0 PSI. 1,008 per case!



Part No	Description
8.697-003.0	Styrofoam Blocks – White

Styrofoam Blocks – Blue

Premium blue styrofoam blocks. The best block money can buy!

- Blue blocks are the very best, especially for the heaviest furniture
- These 2" x 2" x 1" blocks have the highest compressive strength available and will never crush
- Will never leave a mess as it always s-ps off cleanly
- 1,008 per case



Part No	Description
8.697-001.0	Styrofoam Blocks – Blue

Plastic Protector Pads – 1000/cs

Furniture protection solution.

- The solution for protecting furniture legs from moist carpet
- Each box contains two blocks of 425 and one block of 150
- Clear plastic, completely moisture-proof



Part No	Description
8.697-028.0	Plastic Protector Pads 1000/cs – 3 x 3
8.697-030.0	Plastic Protector Pads 1000/cs – 4 x 4

Safety Items

Boot Hazmat / Flood

Yellow hazmat / flood boots.

- Great foot protection against muddy and watery conditions in many different types of environments and workplaces



Part No	Description
8.697-131.0	Boot Hazmat / Flood – XL
8.697-132.0	Boot Hazmat / Flood – XXL

Disposable Nitrile Gloves

Powdered, nitrile disposable gloves.

- Powdered, nitrile, rolled cuff
- Meets FFDC requirements for food contact
- Ambidextrous
- Greater tactile feel over other latex alter-tives
- 100 per box



Part No	Description
8.697-145.0	Disposable Nitrile Gloves – Large
8.697-146.0	Disposable Nitrile Gloves – Medium
8.697-147.0	Disposable Nitrile Gloves – XL

Dust Mask

White cone mask with elastic, non-rated.

- 50/Box = 20 boxes/cs



Part No	Description
8.697-149.0	Dust Mask

Knee Pads

Save your knees — buy these.

- One size fits all
- Quality construction with comfort in mind
- Quick-release snaps



Part No	Description
8.697-150.0	Knee Pads

Vinyl Disposable Gloves

Seamless, vinyl, latex-free disposable gloves.

- Latex-free
- Ambidextrous
- Lightly powdered
- Rolled cuff
- 100 per box
- Meets FFDC requirements for safe food handling



Part No	Description
8.697-137.0	Vinyl Disposable Gloves – Large
8.697-148.0	Vinyl Disposable Gloves – Medium
8.697-138.0	Vinyl Disposable Gloves – XL

Nitrile Flock-Lined Gloves

Strong, chemical-resistant nitrile gloves. Price per dozen.

- Green 15 mil
- 12" nitrile flock lining
- Strong, chemical-resistant, including petroleum-based products
- Meets FFDC requirements for food contact



Part No	Description
8.697-143.0	Nitrile Flock Lined Gloves – Medium
8.697-144.0	Nitrile Flock Lined Gloves – XL

Shoe Covers – Blue

Large, 100% polypropylene, blue shoe covers.

- White tread for traction
- Elastic opening for a snug fit around the ankle



Part No	Description
8.697-432.0	Shoe Covers – XL, Box / 300

Maxshield Coveralls with Hood and Boots

Coveralls come complete with hood and elasticized boots.



Part No	Description
8.697-156.0	Coveralls w/ Hood and Boots – Medium
8.697-155.0	Coveralls w/ Hood and Boots – Large
8.697-157.0	Coveralls w/ Hood and Boots – XL
8.697-158.0	Coveralls w/ Hood and Boots – XXL

Shoe Covers – White

200/cs.



Part No	Description
8.697-139.0	Shoe Covers – White

Safety Glasses / Amber

Amber lens safety glasses.



- These safety glasses are the next generation in super-cool, low-cost protective eyewear
- Ultra-fashionable impact protection that meets and exceeds ANSI Z87.1+ standards

Part No	Description
8.697-140.0	Safety Glasses / Amber

Safety Glasses / Clear

Clear lens, wrap-around safety glasses.



- Adjustable temples for length and flexibility
- Lightweight and comfortable to wear
- Meets Z87.1 safety standards

Part No	Description
8.697-142.0	Safety Glasses / Clear

Splash-Proof Safety Glasses

Chemical splash goggle.



- Frame material – PVC plastic
- Lens material – polycarbonate
- Lens coatings – Duramass® scratch-resistant hard coating)
- Lens thickness – .060mm
- Strap – rubber (rubber straps on the protective goggles are latex-free)
- Style – indirect ventilation for chemical splash
- Replacement lenses available
- All lenses provide 99.9% UV protection
- Meets or exceeds ANSI Z87.1+ safety standard
- Light transmissions – Clear – 85%

Part No	Description
8.697-141.0	Splash Proof Safety Glasses

Respirator, Full-Face

MSA full-mask respirator.



- The MSA reusable, full facepiece, offers users comfort and convenience as well as cost-savings
- The facepiece is made of a thermoplastic elastomer, making it remarkably comfortable, soft and lightweight
- This is the MSA full-face mask only, filters and cartridges sold separately

Part No	Description
8.697-370.0	Respirator Full-Face – Medium
8.697-369.0	Respirator Full-Face – Large

Respirator, Half-Face – Large

Advantage half-mask respirator, size large.



- Offers unmatched fit and comfort with a clear blue facepiece
- The thermoplastic rubber subtracts 25% of the weight and adds softness to MSA's Advantage 200 LS respirator
- The patented MultiFlex® System equalizes pressure on the face-seal area, while delivering exceptional stability so the respirator will not collapse during wear
- The AnthroCurve sealing surface instantly conforms to each wearer's unique facial characteristics. Current Advantage 200 respirator wearers require no additional fit testing

Part No	Description
8.697-152.0	Respirator Half-Face – Large

Organic Vapor Respirator Set Cartridge

Chemical cartridges for Advantage respirators.



- NIOSH-approved for respiratory protection against vapors
- Meets OSHA requirements for an approved cartridge

Part No	Description
8.697-133.0	Organic Vapor Respirator Set Cartridge

Disposable Caution Sign

Inexpensive way to show your customers their safety is your primary concern.



- An inexpensive way for carpet cleaners to help keep customers safe
- Because these signs are inexpensive, cleaners can leave them on the job to show customers they care about their safety
- 21" long, folds into an 11 x 6.5 wide triangle

Part No	Description
8.697-428.0	Disposable Caution Sign

Wands and Upholstery Tools

Dual-Jet Wand

12" head, 1100PSI, 60" length.

- 2-jet design uses standard 11002 T-jets
- Side splashguard helps to contain overspray
- Stainless-steel solution hose
- Full-flow vacuum extraction
- Precision nozzles for best performance



Part No	Description
8.697-192.0	Dual Jet Wand

Low-Profile Wand, 4-Jet

If you want your wands to utilize the full potential of your truck mount's blower to get the fastest drying time, then this is the wand for you.

- 4-jet design uses standard V-jets 95015
- Side splashguard helps to contain overspray
- Goodyear, 3000 PSI solution hose
- Full-flow vacuum extraction
- Precision nozzles for best performance
- 2" tube



Part No	Description
8.697-191.0	Low Profile Wand 4-Jet – 12"

Gum Blaster

This 4" wonder tool does it all. Its double-bend design makes it an easy, comfortable wand to use.

- All Stainless-steel
- 800psi brass valve
- Closed-spray chamber
- Padded assist handle
- Stainless-steel solution line



Part No	Description
8.697-193.0	Gum Blaster

Detail Tool k-800 PSI Valve w-Whip Closed

- 4"-wide vacuum path
- Smooth head for improved suction
- Full-flow vacuum extraction
- Precision nozzles for best performance



Part No	Description
8.697-182.0	Detail Tool K-800PSI Valve w-Whip Closed

Padded Assist Handle



Part No	Description
8.697-188.0	Padded Assist Handle – 1.5"
8.697-190.0	Padded Assist Handle – 2"

Stair Wand 22" Straight

22" straight with 2" flair tube. This stair tool's design and its high-pressure water and steam enable you to remove ground-in dirt on stairs from a standing position.

- 2-jet design uses standard 11002 T-jets
- Side splashguard helps to contain overspray
- Stainless-steel solution hose
- Full-flow vacuum extraction
- Precision nozzles for best performance



Part No	Description
8.697-195.0	Stair Wand 22" Straight

Swivel-Head Ergonomic Stair Tool 30"

500PSI, open spray.

- 500 PSI, V2P brass valve
- Padded-assist handle
- Head swivels easily and stays in rotated position
- 1-jet brass Vee jet
- Perfect height for cleaning stairs



Part No	Description
8.697-200.0	Swivel-Head Ergonomic Stair Tool 30"

Upholstery Tool 4" – Closed

Precision nozzles for best performance. Smooth 4" vacuum path head for improved suction.

- Tube diameter: 1.5"
- Head width: 4"
- Length: 10"
- Nozzles: 2503 or 2504
- Valve: K 105
- Pressure: 800 PSI
- Weight: 1.5 lbs
- Full-flow vacuum extraction



Part No	Description
8.697-186.0	Upholstery Tool 4" – Closed

Upholstery Tool 4" – Open

Precision nozzles for best performance.
Smooth 4" vacuum path head for improved suction.

- Tube diameter: 1.5"
- Head width: 4"
- Length: 10"
- Nozzles: 2503 or 2504
- Valve: K 105
- Pressure: 800 PSI
- Weight: 1.5 lbs
- Fill-flow vacuum extraction



Part No	Description
8.697-187.0	Upholstery Tool 4" – Open

Window Washing Tools

Rub Out PT – 12/cs

Professional glass cleaner for removing hard water stains, rust, mineral deposits, lime scale and soap scum.

- Scrub stains without harming surface
- Super strength with a pleasant scent



Part No	Description
8.697-294.0	Rub Out PT 12/1 pint bottles

Window Washing Bucket – 6 Gallon

Heavy-duty bucket with ergonomic handle for glass cleaning.
Accommodates 18" washers and squeegees.

- Heavy-duty, 6-gallon bucket with larger footprint for increased stability
- Easily fits 18" washer
- Rounded pour spouts on two corners make it easy to empty with more control
- Ergonomically-designed handle for comfort is stiffer and more stable for balance when carrying
- Use with optional snap-on lid and castors or bucket barge



Part No	Description
8.697-323.0	Window Washing Bucket 6 Gallon

ErgoTec Safety Scraper 1.5"

Sturdy s-p-on lid for Pro-Bucket.

- Unique locking system eliminates blades from sliding out while working
- Uses standard No. 9 (1-1/2") razor blades (not included)
- Includes all the features of the SafetyScraper with the added comfort of the new ergonomic grip
- Rubber grip prevents scraper from slipping in hand which makes removing soil from surfaces even easier



Part No	Description
8.697-284.0	ErgoTec Safety Scraper 1.5"

Scraper Blades – 100 Blades/pk

Safety scraper replacement blades.

- Razor sharp No. 9 (1-1/2") standard blade for removing dirt
- Packed in a convenient reclosable plastic tray so blades are kept safe and dry to prevent rusting



Part No	Description
8.697-183.0	Scraper Blades – 100 Blades/pk

T-Bar ErgoTec®

Ergonomic T-bar with polypropylene handle.

- Features an ergonomic, two-component polypropylene handle for less strain and more control
- Water wells for high-water retention
- Attaches to poles with a press fit for out-of-reach cleaning



Part No	Description
8.697-293.0	T-Bar ErgoTec – 14"

S-Channel with Soft Squeegee

Stainless-steel "S" channel complete with ErgoTec soft replacement squeegee.

- Strong, long-lasting and rust-free stainless-steel construction
- Fits on ErgoTec, ProStainless-steel and GoldenPro squeegees
- Notched-channel system will not slip, wobble or bend



Part No	Description
8.697-285.0	S-Channel w/ Soft Squeegee – 6"/10 per pack

Squeegee Soft – 10/pk

Soft squeegee for window cleaning in reclosable blister pack.

- Ideal for colder temperatures
- Conforms to uneven surfaces
- Better glide with streak-free performance
- Longer lasting / superior packing
- Comes in 10/pk



Part No	Description
8.697-283.0	Squeegee Soft 10/pk – 18"
8.697-277.0	Squeegee Soft 10/pk – 12"
8.697-272.0	Squeegee Soft 10/pk – 6"

Squeegee Soft Promo – 25/pk

PromoPack soft rubbers in storage box.

- 12" soft rubbers in each pack, 25 pack
- Free box for storing rubbers and channels
- Reusable, adjustable UV-resistant plastic tube protects against dampness



Part No	Description
8.697-275.0	Squeegee Soft Promo 25/pk – 12"

FIXI-Clamp

Plastic clamp for attaching tools like brushes, sponges, cloths and other tools.

- Made of fiberglass-reinforced nylon
- Innovative design quickly and easily grips sponges, rags, cloths, chamois and mop heads by simply tightening the locking collar
- Also holds the HANDI-BRUSH
- Combined with an Unger telescopic pole, the Fixi becomes a high-rise cleaning tool to solve many cleaning problems without climbing dangerous ladders
- Use with many types of cleaning solvents and liquids
- Attaches easily to all Unger Poles



Part No	Description
8.697-322.0	FIXI-Clamp

Standard Sponge

- Use dry to clean walls, vents, ceilings and for fire restoration
- Made of standard sponge material
- Locks in the jaws of the Fixi Clamp



Part No	Description
8.697-278.0	Standard Sponge

Equipment

1200 Series	7
1700 Series	13
1800 Series	5
333 Model	2
5700/5800 Series	5
700 Series	3
900/1400 Series	4
9400 Series	9
BD Series	10
BDE Series	14
BX Series	10
CWC Series	13
DB Series	11
ET Series	14
Gas-Engine Series	6
HC Series	11
HD Series	12
HD Series	14
Heat Miser	15
Hot Box	11
HWE Series	8
Redhot Cannon	15
SuperSkid HSDS Series	8
SuperSkid HSS Series	8
Trail Blazer	9

Hotsy Branded Parts

Adjustable Nozzle	22
Ceramic Plunger Kits	29
Coil Insulation	32
Coils	32
Cold Water Lances	16
Color-Coded 1/4" QC Nozzle Kits	22
Complete Seal Kits	29
Detergent Flow Meter	31
Downstream Chemical Injectors	30
Dual Lance	16
FasPump Quick Change Pump Assemblies	25
Float Tank	31
Flow Switch	31

Fuel Filter/Water Separator	18
Geared Reduction for Hotsy Pumps	32
Guns	16
Hot Water Lance	16
HOTSY Adjustable Fan Nozzle	21
HOTSY Fuel Filter/Water Separator	18
HOTSY High / Low Adjustable Fan Nozzle	21
Hotsy Hose Reels	19
Hotsy Nozzle Protector	21
HOTSY Nozzles	21
Hotsy Stackable Hose Reels & Accessories	20
Hotsy Twist Quick Couplers	22
Inlet Chemical Injector	30
Lance Grip	16
Maintenance Kit	29
Plunger Oil Seal Kits	29
Pressure Relief Valves	30
Pressure Switch	31
Provides 3 times longer seal life	23
Pump Oil	30
Pump Repair Kit Selection Chart	27
Pump Seal Kits	29
Pump Tool Kits	29
R1 1-Wire 4000 PSI Hose	17
R2 1-Wire 5000 PSI Hose	17
R2 2-Wire 6000 PSI Hose	17
Side Handle	16
ST-56 Rollover Nozzle Head	22
The HOTSY Pump	23
Thermostats	31
Touch-Up Paint	18
Tuff-Flex 1-Wire 3000 PSI Blue Non-Mar Hose	18
Tuff-Flex 2-Wire 4500 PSI Blue Non-Mar Hose	18
Two-Gun Tee Coupler	22
Unloaders	30
Valve Kits	29
Wayne Burner Replacement Part Cross Reference Chart	34
Wayne Burners	33

Detergents

All Purpose Cleaners	36
----------------------	----

Aluminum & Stainless Steel Cleaners 38
 Animal Hygiene & Bio-Security 41
 Chemical Dispensing Equipment 43
 Degreasers 37
 Environmentally Friendly 39
 Floor Care 41
 Graffiti Remover 40
 Institution & Food Preparation 40
 Oil Field & Heavy Equipment Cleaners 38
 Parts Washers 41
 Specialty Cleaners 40
 Transportation Specialty Cleaners 39
 Vehicle Wash Detergents 36

Generic Parts

A

A+ Surface Cleaner 167
 Accumulator – Pulse Dampener 113
 Accumulator by Interpump 113
 Adapters – Brass 68
 Adapters – Steel 71
 Adjustable Bronze Float Valves 128
 Adjustable Flow-Thru Thermostat 162
 Adjustable Foamer with Tank 174
 Adjustable Nozzle 89
 Adjustable Nozzle Holder 51
 Adjustable Thermostat 162
 Admiral Pump Repair Kits 100
 Air Filter / Regulators 177
 Air King Pivoting High-Velocity 200
 Air Valve – Coil Blow Out 133
 Air-Driven Pump 177
 Air-Operated Pump 177
 Air-Power Sprayers 174
 Amazing Pocket Reference – Third Edition 175
 Ametek-Lamb Vacuum Motors 180
 AMP and Voltmeters 135
 Anti-Seize Compound 114
 AP Dump Guns 48
 AP Hose Reels 62

AP Trigger Gun 45
 AP Uninsulated Lances 50
 AP Vacuum Motors 179
 AP1000 Open Gun 48
 Aqua Master™ Model 440 183
 Aquatec 550 Series Diaphragm Pump 191
 AR Pump Kits 111
 AR Pump Repair Kit Selection Chart 110
 AR Triplex Ceramic Plunger Pumps 109
 Automatic Pressure Regulator 117
 Aviation Snips for Most Metals 200

B

Backflow Preventor – Check Valve 130
 Baldor Motors – C-Face Open Drip Proof (ODP) 137
 Baldor Motors – Open Drip Proof (ODP) 138
 Ball Shut-Off Valve 1/4" 200
 Ball Valve - 3-Way 131
 Ball Valves - Brass 131
 Ball Valves - Brass Mini 131
 Ball Valves - Compact PVC 131
 Ball Valves - Polypropylene 131
 Ball Valves - PVC 131
 Banded Coupling 73
 Base Plates for Igniters 147
 Battery Boxes with Cover, Marine Style 166
 Beckett Misc. Parts 143
 Beckett Tune-Up Kit 146
 Belt Drive Pumps 91
 Big Guns 47
 Big Stainless-Steel Lances and Side Handles 50
 Black Pressure Switch 155
 Blower Wheel 145
 Blower Wheels 146
 Blue Top Filter 77
 Boot Hazmat / Flood 207
 Brass Bulkhead / Tank Fittings 193
 Brass Check Valves – Spring-Loaded 129
 Brass Float Valve Assembly 128
 Brass Float, Ball and Stem 128
 Brass Metering Valve 132

INDEX

Brass Pressure Regulator	192	Circuit Breakers	160
Breaker Switches	163	CleanCut Fuel Pump	146
Briggs & Stratton Engine Parts	136	Clear Bowl Fuel Filter	77
Briggs & Stratton Engines – Gasoline	136	Clear PVC Tubing	58
Brushes	173	Clear Reinforced PVC Tubing	57
Bulkhead Fittings	193	Cold Weather Garden Hose	57
Burner Ignitors	146	Comet Pumps and Pump Kits	111
Burner Ignitors	147	Common Parts – Beckett & Wayne	145
Burner Motors	145	Compact Foamer	174
Burner Transformers	147	Compact Pressure Switch	155
Burner Transformers	147	Compact Thermal Relief Valves	133
Bushings – Brass	68	Complete Pump Extraction Kit	114
		Complete Seal Kits	97
		Complete Wheels	166
		Connector 1.5" Stainless-Steel	201
		Connector 1.5"-2" Stainless-Steel	201
		Connector 2" Stainless-Steel	201
		Connector 2" Stainless-Steel 'Y' Vac	201
		Connector Hose – 2'-10'	59
		Connector Hose / Car Wash Bay Hose – 12'-25'	180
		Connector Hose / Car Wash Bay Hose – 12'-25'	59
		Connector: Barb Hose 1.5"-1.5"	201
		Connector: Barb Hose 2"-1.5"	201
		Connector: Barb Hose 2"-2"	201
		Contactors & Relays	187
		Control Set "W" Series / Integrated Regulator/Unloader	120
		Controller and Contractor Tool - Genisys™	143
		Copper and Plastic Float Balls	128
		Cord Caps/Plugs	163
		Cord Hugger 3 x 12	203
		Corrosion-Resistant ABS Gauge	134
		Coupler: 1/4" Female	201
		Coupler: 1/4" Female Stainless-Steel	201
		Coupler: 1/4" Female, Secure Lock	201
		Coupler: 1/4" Male Quick Connect PH	202
		Coupler: 1/4" Male Quick-Connect Econo.	202
		Coupler: 1/4" Male Stainless-Steel	202
		Coupler: Quick Connect 1/4" F Econo.	202
		Couplers - Quick Connective	65
		Couplers Built by Browning or Lovejoy	140
		Coxreels Hose Reels	63
		Crimp Fittings	57
		Cross – 4 Connects	72
Cam Switch ("Big Boot")	161		
Cam Switch and Box – 60 AMP On/Off	161		
Car Wash Booms - "Reflex"	177		
Car Wash Vacuum Hose CW150 and CW200	179		
Carbon, Vapor Lock Filter	198		
Carpet Repair Replacement Blades	200		
Carpet Shears Bent Handle	200		
Ceramic Plunger Kits	97		
Ceramic Plungers	112		
Ceramic Unitized Ball Valve	46		
Check Hose Barbs	69		
Check Valves – 1200 PSI	129		
Check Valves – Swing Action	129		
Check/Foot Valve	75		
Chem Injector - 5500 PSI Stainless Steel	124		
Chemical Filter - Brass	74		
Chemical Injector - ST-60	125		
Chemical Injector - ST-62 Variable	125		
Chemical Injectors - 400 Series	126		
Chemical Injectors - Robokim	125		
Chemical Injectors - Robokim Quick-Coupled	125		
Chemical Line w/ Filter	74		
Chemical Meter and Selection Valve - ST-66	132		
Chemical Metering / On-Off Valve	132		
Chemical Metering Valve - ST-61	125		
Chemical Metering Valves	132		
Chemical Strainer - Plastic	74		
Chrome Ball Valve	201		

Cyclone Rotary Flat Surface Cleaner	169	Elbows – 90° – Brass	69
D		Electrode/Insulator Assembly	143
Decals & Labels	188	Enclosure Box for Magnetic Motor Starter Sets	160
Delavan Fuel Nozzles	151	Engine Parts - Kohler Lombardini	137
Delavan Fuel Nozzles - continued	152	Engines - Kohler Lombardini – Diesel	137
Detail Components	186	ErgoTec Safety Scraper 1.5"	210
Detail Tool k-800 PSI Valve w-Whip Closed	209	Erie Motortrol® Valve	183
Diaphragm Check Valves – Nylon	193	Extech pH Meter Buffer Solution	197
Diaphragm Float Valve	128	Extended Twist Seal Coupler	66
Diaphragm Kits for Yamada Pumps	176	Extension Wand Control Kit	51
Diaphragm Pump Units	190	Extruded or Forged Tees – Brass	69
Digital Monitor	162	EZ Moves Hard Surface Pro	200
Disposable Caution Sign	208	EZ Moves Pro	200
Disposable Nitrile Gloves	207	F	
Double Hose Reel Stand	204	Faucet Kit Adapter	204
Double Nozzle Head	89	Female Crosses – Brass Extruded	69
Double Shut-Off Couplers and Plugs	66	Fiber Trapper Pre-Filter	198
Draft Diverters & Rain Caps	149	Fiberglass “Super Handles”	173
Drain Cocks	70	Fiberglass Telescoping Wands	52
D-Ring Handi Tie 1.5	203	Field Attachable Couplings	58
Drum / Tank Pump – Crank Type	173	Filter - “The Big One”	74
Drum Pump	206	Filter and Parts - High-Volume	76
Drum Pumps	172	Filters - Clear Bowl	74
Drum Tool Accessories	173	Filters - Heavy-Duty In-Line	74
Dual Lances	49	Filters & Baskets	184
Dual Trigger Lance	50	FIXI-Clamp	211
Dual-Chemical Systems	172	Flanges	115
Dual-Jet Wand	209	Flanges	115
Duckbill Snipping Shears	199	Flat-Free Tires	166
Dump Gun	48	Flex Couplers	115
Dust Mask	207	Flex Couplers	115
		Flex Couplings	143
		Flex Lances	52
		Flex Lances	178
E		Flex Line Bypass / Supply Line Hose	58
Easy-Start Val.	133	Flojet Diaphragm Pump	190
Easy-Start Valve	134	Flow Control Metering Valve	132
EATON Cutler-Hammer DP Contactors	157	Flow Control Metering Valve	132
Elbow – Steel	72	Flow Meters	133
Elbows - 45°	72	Flow Selector Valve	131
Elbows - 90°	73	Flow Switch	154

Flow Switch 154

Flow Switch - 7300 PSI Stainless-Steel 155

Flow-Thru Gun 48

Foam Brush and Accessories 177

Foam Cannon 90

Foam Cannon 174

Foam Jet Kit 174

Foam Nozzle Attachment 195

Foot-Controlled Pressure Valve 172

Forged-Brass Ball Valves 130

Foster Double Shut-Off Quick Couplers 66

Frames, Direct Drive & Belt Drive. 165

Fuel Caps 166

Fuel Conditioner and Soot Remover. 146

Fuel Filter / Water Separator. 77

Fuel Filter / Water Separator. 77

Fuel Filters 76

Fuel Oil Pressure Gauge 134

Fuel Pumps 146

Fuel Solenoid Valve - 12V DC KIP 147

Fuel Tank - 9-Gallon Diesel. 165

Fuel Tanks 165

Fuses 160

Fuses 178

Fuses 188

G

Galvanized Pipe Fittings 73

Garden Hose – Apex Quality. 56

Garden Hose Fittings 71

Gas Burner Rings – N/G or L/P Gas Jets 148

Gas Pilots. 150

Gas Regulators 149

Gas Valve Accessory Components 153

Gas Valves - 1" by Robert Shaw. 150

Gas Valves – LP or Natural. 153

Geared Reduction 114

Geared Reduction 114

Geared Reduction Units 114

General Fuel Filter Element. 77

General Pump GL5 80w-90 Gear Lube. 113

General Pump TMT Flow Switch 154

Genuine Interpump / General Pump Kits 107

GFCI Module 20 Amp – 120V or 240V 163

Giant Trigger Guns 45

Gloves 175

Goff's Curtain Walls 170

Grandi Brush 205

Grandi Brush (Head Only) 205

Grandi Groom 205

Grandi Groom (Head Only) 205

Grandi Groom Conversion 206

Ground Fault Circuit Interrupters (GFCI) 164

Gum Blaster 209

Gun Assembly - 910 Spot Spray. 191

Gun Swivel. 67

Gutter Cleaner Attachment. 51

H

Handi Brush 205

Handi Groom Brush 206

Handles 184

Hard-Surface Spinner Tool. 196

Heating Elements & Thermostats. 184

Heavy-Duty Swivels 192

HEPA Filter PRED 1200 198

Hex Coupling – Steel 72

Hex Couplings – Brass. 68

Hex Couplings - Reducing – Brass. 68

Hex Head Plugs 70

Hex Nipple – Steel 72

Hex Nipples – Double – Brass 68

Hex Pipe Plugs – Steel 73

Hex Reducing Nipples – Brass. 69

Hex Socket Head Plugs 70

Hide-A-Hose Swivel Cuff 202

High-Limit Switch 156

High-Limit Switch w/ Wire Lead. 156

High-Pressure Ball Valves 130

High-Pressure Check Valves 129

High-Pressure Nozzle Filters 88

Hi-Lo Injector 125

HL250 High/Low Variable Angle Nozzle 89

Hobby Gun, Lance and Hose 52
 Hobby Hose 56
 Honda Engine Parts 136
 Hose - 1-Wire 53
 Hose - 2-Wire 53
 Hose - 3/8" Blue Tuff-Flex 1-Wire 4000 PSI 55
 Hose - 3/8" Blue Tuff-Flex 2-Wire 6000 PSI 55
 Hose - 3/8" Gray - Wrapped 54
 Hose - Legacy High-Pressure 53
 Hose - Legacy Rawhide 2-Wire 3/8" Blue 54
 Hose - Rawhide 1-Wire 3000 PSI Smooth Non-Marking 54
 Hose - Whitewater® Combination Steam Hose 55
 Hose Barbs – Brass 70
 Hose Bend Restrictors 56
 Hose Clamps 71
 Hose Cuff 1.5"-2" Small End Threaded 202
 Hose Cuff 2" Swivel Reducer 202
 Hose Cuff 2"-1.5" Both Ends Threaded 202
 Hose Hook 1.5 202
 Hose Hugger 3 x 27 202
 Hose Hugger 3 x 34 202
 Hose Reel Stand 204
 Hour Meters for Gasoline Engines 135
 Hudson Float Valve 129
 Hypro Roller Pumps 189

I

Indicator Lights 163
 Industrial Chemical Sprayer 191
 Injector - Adjustable Quick-Connect 127
 Injector - Amerimax 124
 Injector - ST-64 Up Stream 125
 Injectors - Brass 127
 In-Line Can-Type Filters and Parts 75
 In-Line ClearView Filter 75
 In-Line Filter - All Metal 74
 In-Line Filter - Green-Cap 74
 In-Line High-Pressure Nozzle Filters 76
 Instant Hold Replacement Disks 200
 Insulation and Rigid Disc/Donuts 153
 Interchangeable Orifice – Fits Nozzles Above 88
 Interpump / General Pump Kit Selection Chart 106

Interpump / General Pumps 103
 Interpump Packing Extractor Tool 113

J

J.E. Adams Gun 45
 Jetter Pulse Valves 112
 JIC Nipples – Brass 69
 JIC Swivels 68
 JIC x Pipe Nipples 69
 Junction Boxes 159

K

K Series Pressure Regulators 120
 K Series Pressure Regulators Kits 120
 Kerick Float Valve 129
 Keyed Ignition Switch – 12V DC 137
 Kip Solenoids 182
 Knee Pads 207

L

Lafferty Airless Foam Kit 174
 Lance Handles/Accessories 51
 Lance Nozzle Couplers 87
 Legacy “Best” Spray Gun 45
 Legacy “Industrial” Spray Gun 45
 Legacy Air Mover (LAM3) 199
 Legacy Compact Foamer 90
 Legacy Flow Switch 154
 Legacy Flow Switch 154
 Legacy HD Pump Repair Kit Selection Chart 101
 Legacy Hose Reel Swivels 61
 Legacy Hose Reels 61
 Legacy Industrial Gun & Lance 52
 Legacy Oval Molded Grip Lances 49
 Legacy Pump Repair Kit Selection Chart 98
 Legacy Pump Repair Kits 99
 Legacy Pump Repair Tool Kit 98
 Legacy Pumps (Belt Drive Units) 92
 Legacy Pumps (Direct Drive Units) 94

Legacy Square Molded Grip Lances	49
Legacy Stackable Hose Reels	60
Legacy Superlite Stainless-Steel Dual Lance	48
Legacy Universal Unloader (UU1)	116
Legacy Vented Lances	50
Lid Supports	184
Liquid-Tight Strain Relief Connector for Cable, Wire and Tubing	164
Locks for Meter Boxes	178
Long Range Tip – 15 x 1 – Stainless-Steel	192
Low-Flow Brass Pressure Regulator	192
Low-Pressure Swivels	178
Low-Profile Wand, 4-Jet	209
LP Conversion Kit for Robert Shaw	150

M

M407 Trigger Gun	45
Machine Control Cam Switches	160
Magnetic Motor Starters	158
Male Branch Tees – Brass	69
Manual Motor Starter w/ Sealed Box	160
Mat Clamp	171
Maxshield Coveralls with Hood & Boots	208
Measuring Cups	187
Measuring Cups	206
Measuring Cups – 2 oz	206
Mecline AL 35 Gun	47
Medium-Pressure Swivels	178
Merchant Coupling	73
Mini Ball Valves	130
Misc Replacement Parts	188
Misc. Hose Cuffs and Accessories	202
Miscellaneous Parts	166
Moisture Sensor, Hydro Shark	197
Molded Plastic Float Tanks	165
Molded Power Cord	158
Mosmatic Roof Cleaner	169
Mosmatic Surface Cleaners & Duct Cleaner	168
Motors - A.O. Smith – Pressure Washer	139
Motors – Totally Enclosed Fan Cooled (TEFC)	139
Motors - WEG – Pressure Washer	139
MV Hi-Lo Turbo Nozzle	88
MV Hobby Wash Gun	48

MV Lance Handle	51
MV Triple-Function Nozzle	87
MV925 Gun & Lance Kit	52
MV925 Gun, Lance, Hose Kit	52

N

Nap Brush	205
Nickel-Plated Brass Ball Valves	130
Nipples – Brass	68
Nitrile Flock-Lined Gloves	207
Nozzle - Turbo	85
Nozzle - Dirt Killer Rotating	87
Nozzle - Duo-Reg	88
Nozzle - Multi-Fan	88
Nozzle Accessories	147
Nozzle Fan Selection	78
Nozzle Kits - Legacy 4/pk and 5/pk Color-Coded QC	79
Nozzle Protector/Coupler	90
Nozzle Sets - 4/pk and 5/pk Color-Coded QC	80
Nozzle Size Selection Chart	78
Nozzles	186
Nozzles - Broad Spray Stainless-Steel	82
Nozzles - General Pump	80
Nozzles - Legacy Individual 1/4" QC	79
Nozzles - Spraying Systems	81
Nozzles - Suttner Turbo	86
Nozzles for Low-Pressure Applications, Brass	82
Nylon Pressure Regulator	193

O

Oil Burner - 14V ADC	143
Oil Burners	144
Oil Burners - 115V / 230V	142
Oil Solenoid Valve	148
Oil-Fired Hot Box	169
ON / OFF Rotary Switch	158
On/Off Cam Switch	163
On/Off Switch with box ("Elektra")	161
Open Guns	48
Orange 600 Sprayer Hose & Ribbed PVC Sprayer Hose	57

Orificed Hose Barb 70
 O-Ring Tool 113
 O-Rings 64
 Ozone Generator Villa 1000 197

P

PA Float Valve 128
 PA Linear Gun 45
 PA Trigger Gun 47
 Packing and Seal Kits 112
 Packing Extractor 113
 Padded Assist Handle 209
 Perfect Patch 200
 Performance Tables 189
 Phoenix Flow Switch w/ Pilot 154
 Pipe Nipple – Zinc 73
 Pipe Street Elbows 73
 Pipe Tees 73
 Pipe Thread Hex Nuts 70
 Piston Pumps 112
 Plastic Dip Tube Assembly 166
 Plastic Fittings 194
 Plastic Protector Pads 207
 Plunger Oil Seal Kits 97
 Poly-Molded Sprayer 195
 Powered Damper 150
 Predator 1200 Portable Air Scrubber 198
 Predator 600 Portable Air Scrubber 198
 Premium Ball Shut-Off Valve 201
 Pressure and Temperature Test Set 135
 Pressure Gauges 134
 Pressure Loop - 1/4", 3/8" and 1/2", 2-Wire 55
 Pressure Reducer/Injector - Exact-A-Flow 127
 Pressure Regulator 134
 Pressure Switch 155
 Pressure Washer Accessory Kit 52
 Pressurized Drying System-21 199
 Professional Sandblast Head 170
 Professional Stainless-Steel Sprayer 195
 Profit From Power Washing 175
 Propane Gas Hose 150
 Propane Gas Regulators 149

Propane Tanks 150
 Proportioners 183
 PTO Geared Multiplier 114
 Pulley Bushings 141
 Pulleys 140
 Pulleys 141
 Pulsar Unloaders 118
 Pulse Hose 56
 Pump Lube 113
 Pump Oil 113
 Pump Parts and Tools 112
 Pump Rails 97
 Pump Selection Chart for Legacy HD Direct Drive Pump 97
 Pump Technical Information 115
 Pump Valve Kits 96
 Pumps & Pump Seals 186
 Pumptech Pump 114
 Push Button and Contact Blocks 157
 Push-N-Lock Barbs 70
 PVC Check Valve 130

Q

QD Connector Sleeve Set 203
 Quick Connective Couplers - Foster 65
 Quick Couplers 64
 Quick-Coupled Amerimax 124

R

Racor Filter Funnel 77
 Rain Suit 175
 RainTite Switch Box 160
 Red Pressure Switch 155
 Reducing Bushing – Steel 73
 Reference / Calculation Guide 140
 Regulating Relief Valve 124
 Regulator - VS 200 / 180 High-Volume 123
 Regulator / Relief Valve - ST-230 121
 Regulator / Relief Valve - VS 220 124
 Regulator / Relief Valve - VS 350 123
 Regulator / Relief Valve VS 500 High-Pressure 123

INDEX

Regulator / Unloader - ST-261	121
Regulator / Unloader - ST-280	122
Regulator / Unloader VRS3	117
Regulator Valve - Timax Pressure	123
Regulator/Unloader - HM	121
Regulators / Unloaders	117
Relay Switch	158
Relays	159
Replacement Accessories	51
Replacement Fuel Cap	165
Replacement/Repair Kits for Solenoids Valves	182
Respirators	208
Rocker Switches	162
Rollover Nozzle – Twist-Type	89
Rollover Nozzle Head - ST-56	88
Romex Connectors (Metal)	163
Rosebud Nozzle Guard	83
Rotary Switch - 8-Position	178
Rotojet 2000	88
Rotojet 3700 / Rotojet 5800	85
Rotojet Soft – Hard Rotating Nozzle	87
Rotomax Rotating Nozzle 3500 and 5800 PSI	87
Rub Out PT	210
Rubber Parts	165
Rupture Disks	133

S

Safety Glasses	208
Safety Pressure Relief Valves	123
Safety Pressure Relief Valves	133
Sandblast Kit – Carbide Nozzle Industrial Grade	170
Sandblast Nozzles Tips	170
S-Channel with Soft Squeegee	210
Scraper Blades – 100 Blades/pk.	210
Seal Kits	96
Seals & Gaskets	184
Second-Stage Particulate Filter	198
Self Serve Underbody Wand Assembly	170
Series 505 Stainless-Steel	127
Sewer Hose	56
Sewer Hose	172
Sewer/Tube Cleaning Nozzles	90
Sewer/Tube Cleaning Nozzles	171
Shipping Tape and Dispenser	175
Shoe Covers	207
Skimmer Components	187
Slip-on Nozzle Protector	89
Small Engine Test Equipment	140
Smoke Tester – Diagnostic Tool	147
Snap Fuel Nozzle Check Valve	151
Snap N Lock Cuff	203
Snap N Lock Cuff 2"	203
Soap Nozzles	83
Soft-Edge and Hard-Edge Nozzle Protector	83
Solenoid Valve Specifications	181
Solenoid Valves	181
Solenoids w/ Built-In Strainer	182
Solution Hose 50', 1/4" 1500 PSI	203
Solution Hose 50', 1/4" 3000 PSI	203
Solution Hose 50', 3/8" Blue, 3000 PSI	204
Solution Hose Live Swivel Assembly	196
Solution Hose Reel	203
Sonin 4-in-1 Multifunction Detector	196
Sonin Digital Moisture Meter	196
Sonin Laser Targeting Range Finder	197
Sonin Moisture Test Meter	197
Sonin Multi-Measure 45	197
Speedmaster Throttle Control	135
Spotting Bottle	206
Sprayer – Chemical-Resistant	195
Sprayermaster – High-Pressure	195
Sprayermaster – Standard	195
Spray-Flex™ Flex Wand	51
Spraymax Trigger Gun	191
Squeegees	211
ST-1500H Open Gun	48
ST-36 Pit Boss Sludge Sucker	172
ST-51N Adjustable Nozzle	89
Stack Bracket	205
Stainless-Steel Ball Valves – 2000 PSI	130
Stainless-Steel Bay Accessories	178
Stainless-Steel Check Valves	129
Stainless-Steel Float Tank	165
Stainless-Steel Industrial Sprayer	195
Stainless-Steel Pressure Gauges	134

T

Stainless-Steel Pressure Gauges 135

Stainless-Steel Quick Couplers 64

Stainless-Steel Sewer Nozzles 171

Stainless-Steel Sprayer 195

Stair Wand 22" Straight 209

Standard Sponge 211

Starter Solenoid - 12V DC 137

Steam Nozzle 89

Steam Valve 132

Steel Utility Gauges 134

Stems Only 128

Step-Down Transformers 159

Street Elbow – Steel 72

Street Elbows – Brass 69

Street Tee – Steel 72

Street Tees – Brass 69

Styrofoam Blocks – Blue 207

Styrofoam Blocks – White 206

Suction Foot Valve - ST35/35R 75

Surface Cleaner Nozzle Recommendation 169

Suttner Dual Lances 50

Suttner Push and Pull Lance 50

Suttner Trigger Gun 47

Suttner Trigger Guns 46

Suttner Trigger Guns 46

Swivel Assembly 205

Swivel Cuff: Big End Threaded 202

Swivel Grout Brush 205

Swivel Hose Barbs – Low Pressure 70

Swivel-Head Ergonomic Stair Tool 30" 209

Swivels 67

Swivels - 90° 67

Swivels – Ball Bearing 68

Swivels – Right Angle 67

Swivels - Stainless-Steel 67

Swivels – Stainless-Steel Ball Bearing 68

Swivels - Stainless-Steel, High-Pressure and Economy Brass 67

Tandem Hose Clamp 203

Tank Screen/Strainer 76

T-Bar ErgoTec® 210

Tee – 3 Connects 72

Teflon® Thread Sealing Tape 174

Temperature Gauges 135

Thermal Relief Valves 132

Thread Lock Products 175

Timer 160

Timers & Switches 185

Tip-Jet Nozzle System – Tips and Components 83

Toggle / Push Button Switch 156

Toggle Switch - 30 AMP 156

Transformers 178

Trapped Pressure Unloader Valves

Trigger Valves 191

Trigger-Control Spray Lances 192

Trigger-Jet Spray Lances 192

Truck-Mount Hose, Heavy-Duty Blue 204

Truck-Mount Hose, Heavy-Duty Gray 204

TRV Thermal Relief Valves 133

Turbine Series Guns 191

Turbo A+ Nozzle Kit 84

Turbo Nozzles 84

Turntable Drive Components 185

Twin-Diaphragm Spot Spray Pump 193

Twist Seal Couplers 65

Twist Seal Couplers 66

U

Undercarriage Cleaner 169

Universal “Elektra” 161

Unloader - Hypro-Style 121

Unloader - YU – High-Volume 121

Unloader Mounting Block 124

Unloaders - AR Bolt-On 122

Unloaders - Flow-Actuated 122

Unloaders - Gymatic 122

Unloaders - MG4000 Series 123

Unloaders - Pressure-Actuated 122

Unloaders - Pressure-Actuated 13 GPM 122

Upholstery Tool 4" – Closed 209

Upholstery Tool 4" – Open 210

UV Flashlight Blaze 128 LED 196

V

Vac Switch – Burner Control 155

Vacuum Accessories 179

Vacuum Hose Reel 204

Vacuum Hose Shelf Hook 204

Valves - Honeywell Gas 148

Variable Angle Nozzle 89

VB130 Regulator / Unloader 118

VB200 / 150 High-Volume Unloader 118

VB350 / 4 Unloader 119

VB7 Regulator / Unloader 118

VB75 / VB135 119

VB80 / 400 Stainless-Steel Unloader 119

VB85 / 820 Regulator / Unloader 118

VBA35 / VB55 Unloader Valves for Legacy HD Pumps 117

V-Belts - Super “Gripnotch” 141

VBT Unloader 116

Vertical Float Tank Valve 129

Vinyl Disposable Gloves 207

Vinyl Electrical Tape 163

Vinyl Tubing 57

Vinyl-Coated Wand Hook 204

Viper Rotating Nozzle 87

Voltage Regulator - Heavy-duty 15 Volt 137

Voltmaster Generator 162

V-Packing Insertion Tool Kit 113

VRT100 Unloader Valves 118

VRT3 Unloader Valves 117

W

Wall Buddy 206

Wash Gun - RB65 179

Water Broom 16" 171

Water Leveling System 187

Waterproof ExStik pH Meter 196

Wayne Burner Parts 145

Whisper Wash Flat Surface Cleaners 167

Whisper Wash Flat Surface Cleaners Mosmatic Gun Swivel 168

Winco AC Generator 162

Window Washing Bucket – 6 Gallon 210

Wire Loom – For Wiring Harnesses 163

X

X-Jet Long Range Nozzle 51

XT Overloads for DP Contactors 157

Y

Yamada Pumps 176

Y-Trap Strainer 75

Z

Zinc-plated Heavy Wall Steel Pipe Fittings 71

ZipWall 12' Poles – 2/pk 199

ZipWall Carrier Bag 199

ZipWall Side Clamp – 2/pk 199

ZipWall Zipper 199

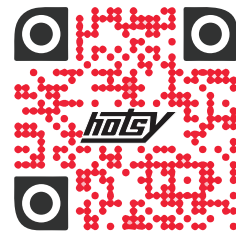

Scan with QR
code reader
to watch the
Hotsy Dealer
video

NOTHING CLEANS LIKE A HOTSY

AT HOTSY WE MAKE THE BEST PRESSURE WASHERS. They come with the best warranties in the industry and are backed with expert service, great parts and detergents made specifically for your cleaning needs. Hotsy delivers one of the most rugged and durable lines of industrial pressure washers on the market. We are proud of our network of authorized Hotsy dealers throughout North America who will help you select the best equipment and accessories for your cleaning job. Our dealers provide on-site cleaning evaluations and next day service calls by factory certified technicians. Excellent warranties, superior performance and ETL safety certified. Buy a Hotsy and you'll have peace of mind knowing you have a product built to last.



1024 BRYDEN AVE SUITE 1
LEWISTON, ID 83501
(208) 790-0365

WWW.THEPRESSUREDR.COM